

Operations Manual

Medical

Zoom Critical Care Bed
Model 2040

For parts or technical
assistance call
800 327 0770 (option 2)

**Important
Information**

File in your
maintenance
records

Table of Contents

Introduction	
Specifications	2
Warning / Caution / Note Definition	3
Safety Tips And Guidelines	3–5
Set–Up Procedures	6
Symbols	7
Base Operation Guide	
Brake Pedal Operation	8
Battery Charging/Power Drive Wheel Operation	9–11
Litter Operation Guide	
CPR Emergency Release Usage	12
CPR Board Usage	12
Foley Bag Hooks Usage	12
Siderail Operation Guide	
Positioning Siderails	13
Siderail Control Panel Lights	14
Siderail Function Guide	15, 16
Head End Control Panel Operation Guide	17
Foot Board Operation Guide	
Foot Board Control Panel Guide	18–23
Scale System Control Panel Guide	24, 25
Weigh System Usage	
Preparing the Bed for Patient Stay/Zeroing the Scale System	26
Adding or Removing Items During a Patient's Stay	27
Displaying Trendelenburg or Fowler Angle	28
Converting the Patient's Weight	28
Displaying the Weight Log	29
Viewing the Patient's Weight in Gain/Loss Mode	30
Changing the Numerical Value of Displayed Weight	31
Optional Pendant Operation	32
Operating IV Poles	33
Preventative Maintenance	
Nurse Call Battery	34
Circuit Breakers	34
Cleaning	35
Preventative Maintenance Checklist	36
Limited Warranty	
Obtaining Parts and Service	37
Supplemental Warranty Coverage	37
Return Authorization	38
Freight Damage Claims	38

Introduction

INTRODUCTION

This manual is designed to assist you with the operation of the Model 2040 Zoom® Patient Transport Frame. Read it thoroughly before using the equipment.

SPECIFICATIONS

Safe Working Load	500 pounds or 227 kilograms 
Scale System Capacity (optional equipment)	Loads weighing up to 500 pounds (227 kilograms)
Scale System Accuracy (optional equipment)	± 1 pound of total patient weight at any bed position ¹ (patients weighing 100 pounds or less) ± 1% of total patient weight at any bed position ¹ (patients weighing greater than 100 pounds)
Overall Length/Width	L-93" /W-42.5" or L-238 cm /W-108 cm
Minimum/Maximum Height (Standard)	18" to 32.5" ± 0.5 / 46 cm. to 82.5 cm.
Minimum/Maximum Height (Enhanced)	19.5" to 34.5" ± 0.5 / 49.5 cm. to 88 cm. (Add 2 inches if the bed has 8" casters.)
Fluoro Access	16"
Knee Gatch Angle	0° to 30°
Back Angle	0° to 90°
Trendelenburg/Reverse Trendelenburg	+10° to -12° ± 1°
Electrical Requirements	115 VAC, 60 Hz, 7.0 Amps
Battery Voltage	24 V, 31 Ah
Outlet Option	125 VAC, 5A, 60 Hz

¹ If the bed is equipped with the enhanced height option, the scale accuracy is as described above for litter angles from 0° to ± 5° Trend.

MATTRESS SPECIFICATIONS

Thickness	6"
Width	>= 35"
Length	>= 84"
ILD	80

Stryker reserves the right to change specifications without notice.

Safety Tips and Guidelines

WARNING / CAUTION / NOTE DEFINITION

The words WARNING, CAUTION and NOTE carry special meanings and should be carefully reviewed.

WARNING

Alerts the reader about a situation, which if not avoided, could result in death or serious injury. It may also describe potential serious adverse reactions and safety hazards.

CAUTION

Alerts the reader of a potentially hazardous situation, which if not avoided, may result in minor or moderate injury to the user or patient or damage to the equipment or other property. This includes special care necessary for the safe and effective use of the device and the care necessary to avoid damage to a device that may occur as a result of use or misuse.

NOTE

This provides special information to make maintenance easier or important instructions clearer.

Before operating the 2040 Zoom® Patient Transport Frame, it is important to read and understand all information in this manual. Carefully read and strictly follow the safety guidelines listed on this page. To ensure safe operation of the unit, methods and procedures must be established for educating and training hospital staff on the intrinsic risks associated with the usage of motorized electric frames.

WARNING

- The 2040 Patient Transport Frame is equipped with a hospital grade plug for protection against shock hazard. It must be plugged directly into a properly grounded three-prong receptacle. Grounding reliability can be achieved only when a hospital grade receptacle is used.
 - Serious injury can result if caution is not used when operating the unit. Operate the unit only when all persons are clear of the electrical and mechanical systems.
 - To help reduce the number and severity of falls by patients, always leave the bed in the lowest position when the patient is unattended.
 - When raising the siderails, listen for the "click" that indicates the siderail has locked in the up position. Pull firmly on the siderail to ensure it is locked into position. Siderails are not intended to be a patient restraint device. It is the responsibility of attending medical personnel to determine the degree of restraint and the siderail positioning necessary to ensure a patient will remain safely in bed.
 - Always apply the caster brakes when a patient is getting on or off the bed. Always keep the caster brakes applied when a patient is on the bed (except during transport). Injury could result if the bed moves while a patient is getting in or out of bed.
 - Ensure the brakes are completely released prior to attempting to move the unit. Attempting to move the unit with the brakes actuated could result in injury to the user and/or patient.
 - Put the drive wheel in the neutral position and release the brakes before pushing the unit manually. Do not attempt to push the unit manually with the drive wheel engaged. The unit will be difficult to push and injury could result.
 - The CPR emergency release requires assistance to lower the Back if the angle of the Back is above 80°. Attempting to lower the Back in this position without assistance may result in injury to the operator.
 - The power save mode is activated after one hour on battery power with no motion release switch activation. Functions including Bed Exit, scale and motion will cease to operate when the unit enters the power save mode. Injury to the patient could occur if proper patient monitoring protocol is not observed.
-

Safety Tips and Guidelines

WARNING

- The Bed Exit System is intended only to aid in the detection of a patient exiting the unit. It is NOT intended to replace patient monitoring protocol. The bed exit system signals when a patient is about to exit. Adding or subtracting objects from the frame after arming the bed exit system may cause a reduction in the sensitivity of the bed exit system.
- To avoid pinching your fingers, place the IV pole in the upright position before using the drive handle.
- Always unplug the power cord and push the battery power on/off switch to the “OFF” position before service or cleaning. When working under the frame, always place blocks under the litter frame to prevent injury in case the Bed Down switch is accidentally activated.
- Battery posts, terminals and related accessories contain lead and lead compounds, chemicals known to the State of California to cause cancer and birth defects or other reproductive harm. **Wash hands after handling.**
- The 2040 Patient Transport Frame is intended for use by trained hospital personnel only.
- Warning: Service only by qualified personnel. Refer to maintenance manual.
- Do not modify the 2040 Patient Transport Frame. Modifying the unit can cause unpredictable operation resulting in injury to the patient or operator. Modifying the unit will also void its warranty.
- When using any mattress and/or mattress overlay that increases the overall height greater than 6” extra caution and or operator supervision is required to help reduce the likelihood of a patient fall occurring.

To avoid possible injury and to assure proper operation when using a powered mattress replacement system such as XPRT:

- Confirm proper scale system operation following mattress installation. For best results, secure the therapy mattress power cord to prevent damage to the cord or interference with the bed frame and the scale system.
- Do not zero bed scales or weigh patient with Percussion, Vibration, Rotation or Turn–Assist active. Patient motion and position resulting from the dynamic therapy mattress may adversely affect scale system performance.
- Do not initialize (“arm”) bed exit with Percussion, Vibration, Rotation or Turn–Assist active. The patient motion and position resulting from the dynamic therapy mattress may adversely affect bed exit system performance.
- When using an XPRT Therapy Mattress extra caution and or operator supervision is required to help reduce the likelihood of a patient fall occurring.

CAUTION

- Use caution while maneuvering the unit with the drive wheel activated. Always ensure there are no obstacles near the unit while the drive wheel is activated. Injury to the patient, user or bystanders or damage to the frame or surrounding equipment could occur if the unit collides with an obstacle.
- Use caution when transporting the unit down halls, through doors, in and out of elevators, etc. Damage to the siderails or other parts of the unit could occur if the unit comes in contact with walls or door frames.
- If unanticipated motion occurs, unplug the power cord from the wall socket, push the battery power on/off switch to the “OFF” position (the LED will not be illuminated) and actuate the drive wheel pedal to the neutral position.
- The siderails are not intended to be used as a pushing device. Damage to the siderails could occur.

Safety Tips and Guidelines



CAUTION CONT'D

- The use of a mattress overlay may reduce the effectiveness of the siderail.
- When attaching equipment to the frame, ensure it will not impede normal operation. I.E.: hooks on hanging equipment must not actuate control buttons, equipment must not hide the nurse call button, etc.
- Use caution when lowering the bed with items attached to the optional accessory rail. If caution is not used, items may contact the floor resulting in damage to the items and/or injury to the patient or user.
- The lockout buttons on the foot board lock the Fowler, Gatch and Bed Up/Down functions and prevent motion of the bed. It is the responsibility of attending medical personnel to determine whether these functions should be locked and to use the buttons accordingly.
- Scale function may be affected by siderail/caster interference. With the litter fully lowered or lowered in Reverse Trendelenburg, the siderails tucked under the litter in the storage position and the casters turned, there is the potential for interference between the siderail and the caster. Raise the siderails when lowering the litter to the full down position to prevent the interference from causing the bed's scale system to weigh inaccurately.
- If large fluid spills occur in the area of the circuit boards or motors, immediately unplug the power cord from the wall socket and push the battery power on/off switch to the "OFF" position. Remove the patient from the unit and clean up the fluid. Have maintenance completely check the unit. Fluids can short out controls and may cause the unit to operate erratically or make some functions completely inoperable. Component failure caused by fluids could even cause the unit to operate unpredictably and could cause injury to the patient. DO NOT put the unit back into service until it is completely dry and has been thoroughly tested for safe operation.
- Preventative maintenance should be performed at a minimum of annually to ensure all features are functioning as designed. Close attention should be given to safety features including, but not limited to:

Safety side latching mechanisms	Caster braking systems
Leakage current 300 microamps max.	No controls or cabling entangled in frame mechanisms
Frayed electrical cords and components	All controls return to off or neutral position when released
- The battery tray assembly weighs 50 pounds. Take care when removing the two hex head screws securing it to the base frame or personal injury could result.
- The 2040 Patient Transport Frame is not intended for pediatric use or for patients under 50 pounds.
- Because individual beds may have different options, foot boards should not be moved from one bed to another. Interchanging foot boards between beds could result in unpredictable bed operation.
- The weight of the IV bags should not exceed 40 pounds.
- IV Poles should not be used as a bed push/pull device.
- The cleanliness/and integrity of both ground chains must be maintained to minimize static build-up and discharge.
- Do not add or remove weight when the bed exit system is armed.

The following Caution statements apply to the optional 110V outlet:

- Maximum total load 5A receptacle rating: 125VAC, 5A, 60Hz.
- The total system chassis risk current should not exceed 300uA
- Grounding continuity should be checked periodically.
- Do not use for life-sustaining equipment.
- Use only hospital-grade equipment with electrical outlet.
- Unplug free-standing equipment before transporting the bed.

Set-Up Procedures

 **WARNING**
Potential pinch points



SET-UP PROCEDURES

It is important that the 2040 Patient Transport Frame is working properly before it is put into service. The following list will help ensure that each part of the unit is checked.

- Plug the power cord into a properly grounded, hospital grade wall receptacle. The 12 volt batteries that provide power to the drive wheel and back-up power to the unit functions will charge whenever the power cord is plugged into the wall socket. The batteries require approximately 10 hours of charging time before the bed is put into service.

 **WARNING**

The 2040 Patient Transport Frame is equipped with a hospital grade plug for protection against shock hazard. It must be plugged directly into a properly grounded three-prong receptacle. Grounding reliability can be achieved only when a hospital grade receptacle is used.

-
- Depress the pedal at either side of the frame fully to set the four wheel brakes and ensure all four casters lock. Depress the pedal again to release the brakes.
 - Ensure the siderails raise and lower smoothly and lock in the up and intermediate positions.
 - Run through each function on the foot board control panel and ensure that each is working properly (see function lockout system usage instructions, [page 23](#) and weigh system control panel guide, [page 24](#)).
 - Ensure all functions are working properly on the siderail controls (see siderail instructions on [page 15](#)).
 - Ensure all motion functions are working properly at the head end (see control panel guide [page 17](#)).
 - Raise the Back up to approximately 60°. Squeeze the CPR release handle and ensure the Back and Knee will drop with minimal effort.
 - Unplug the power cord from the wall socket. Push the battery power switch located on the lower left corner of the head end to the “ON” position. Again, verify each function on the foot board and siderails is operating properly.
 - With the battery power switch in the “ON” position and the brakes engaged, verify the “Release Brakes” LED on the head end control panel is illuminated.
 - With the battery power switch in the “ON” position and the drive wheel in the neutral position (not touching the floor), ensure the “Engage Drive Wheel” LED on the head end control panel is illuminated.
 - Run through the operation of the drive wheel (see [page 10](#)) to ensure it is operating properly.
 - If the bed is equipped with the Nurse Call option, verify it is functioning properly prior to patient use.

Symbols



Warning, Refer to Service/Maintenance Manual



Alternating Current



Type B Equipment: equipment providing a particular degree of protection against electric shock, particularly regarding allowable leakage current and reliability of the protective earth connection.

Class 1 Equipment: equipment in which protection against electric shock does not rely on BASIC INSULATION only, but which includes an additional safety precaution in that means are provided for the connection of the EQUIPMENT to the protective earth conductor in the fixed wiring of the installation in such a way that ACCESSIBLE METAL PARTS cannot become live in the event of a failure of the BASIC INSULATION.

Mode of Operation: Continuous

IPX4: Protection from liquid splash



Dangerous Voltage Symbol



Protective Earth Terminal



Potential Equalization Symbol



Medical Equipment Classified by Underwriters Laboratories Inc. with Respect to Electric Shock, Fire, Mechanical and Other Specified Hazards Only in Accordance with UL 2601-1 and CAN/CSA C22.2 No. 601.1

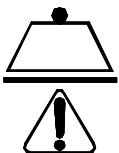

Safe Working Load

Base Operation Guide

BRAKE PEDAL OPERATION

WARNING

Always apply the caster brakes when a patient is getting on or off the bed. Always keep the caster brakes applied when a patient is on the bed (except during transport). Injury could result if the bed moves while a patient is getting in or out of bed.

Ensure the brakes are completely released prior to attempting to move the unit. Attempting to move the unit with the brakes engaged could result in injury to the user and/or patient.

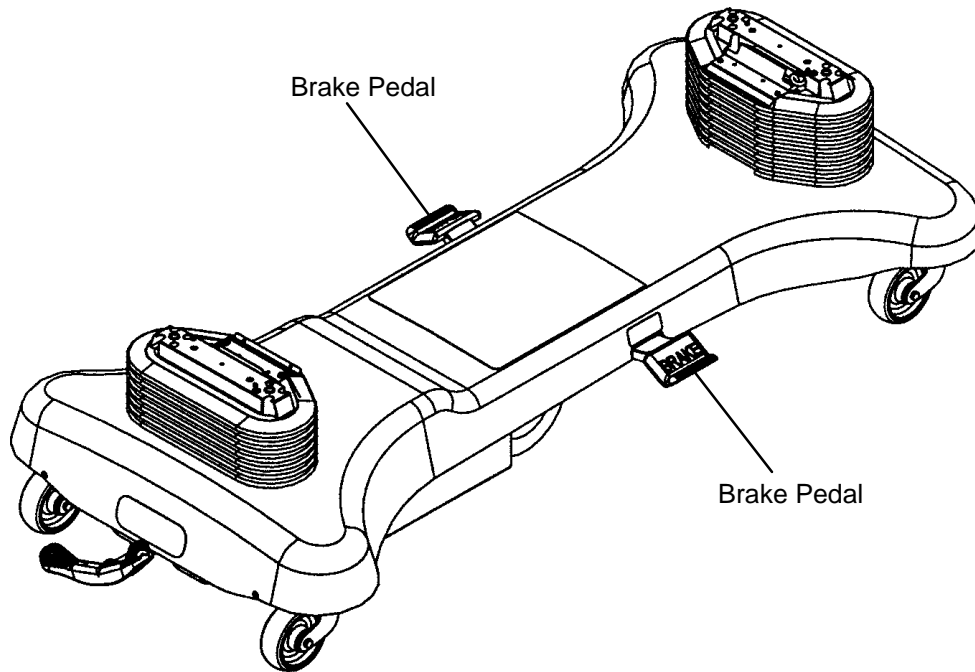

To activate the brakes, push down once on one of the pedals located at the midpoint of the bed on both sides (identified by the label at right). The pedal will remain in the lowered position, indicating the brakes are engaged. To disengage the brakes, push down once and the pedal will return to the upper position.

BRAKE
PRESS TO SET OR RELEASE

NOTE

There are LED lights on the outside of the head end siderails (see [page 15](#)) that will blink when the brakes *are not* engaged only if the power cord is plugged into a wall socket or the battery power switch is turned on. The brakes will still operate properly when the power cord is not plugged in. There is also a “Release Brakes” LED on the Head End Control Panel that will illuminate when the brakes *are* engaged while the battery power switch is on (see [page 17](#)).

Base Operation Guide

BATTERY CHARGING AND OPERATION

1. The unit has two 12 volt batteries to provide power to the drive wheel and back-up power to the unit functions if the power cord is unplugged from the wall socket. Neither the unit functions nor the drive wheel will operate properly if the batteries are not sufficiently charged. The batteries require approximately 10 hours of charging time when they are fully discharged.
2. The batteries are charging whenever the power cord is plugged into a properly grounded, hospital grade wall socket. When the unit is stationary, the power cord should be plugged into a wall socket whenever possible.

NOTE

The battery will operate under slightly decreased power until it has run through 10–15 cycles of usage and recharging.

3. The “Plug Bed In To Charge” LED on the Head End Control Panel will be illuminated while the battery power switch is on if the battery level is low (see [page 17](#)). Plug the power cord into a wall socket to charge the batteries.
4. After one hour on battery power with no motion release switch activation, the unit will enter power save mode and none of the unit’s powered functions will operate. Squeeze either of the motion release switches located under the drive handle to enable the unit functions.

NOTE

The three LED’s on the Head End Control Panel may still be illuminated when the unit is in power save mode. The Battery Power LED located at the left side of the head end of the unit will be illuminated when the unit is in power save mode.



WARNING

The power save mode is activated after one hour on battery power with no motion release switch activation. Functions including Bed Exit, scale and motion will cease to operate when the unit enters the power save mode. Injury to the patient could occur if proper patient monitoring protocol is not observed.

Base Operation Guide

DRIVE WHEEL OPERATION

1. Unplug the power cord from the wall socket and secure the cord sufficiently to prevent entanglement while the unit is in motion. The drive wheel will not operate if the power cord is plugged into the wall socket.
2. Activate the power to the drive wheel by placing the battery power switch located at the left side of the head end of the litter in the "ON" position. The LED will illuminate.
3. Engage the drive wheel by rotating the pedal located at the head end to the left as shown on the label. To place the drive wheel in the neutral position, rotate the pedal to the right.
4. Release the brakes. The drive system will not function while the brakes are engaged. The "Release Brakes" LED on the head end control panel will be illuminated if the brakes are engaged while the battery power switch is on.

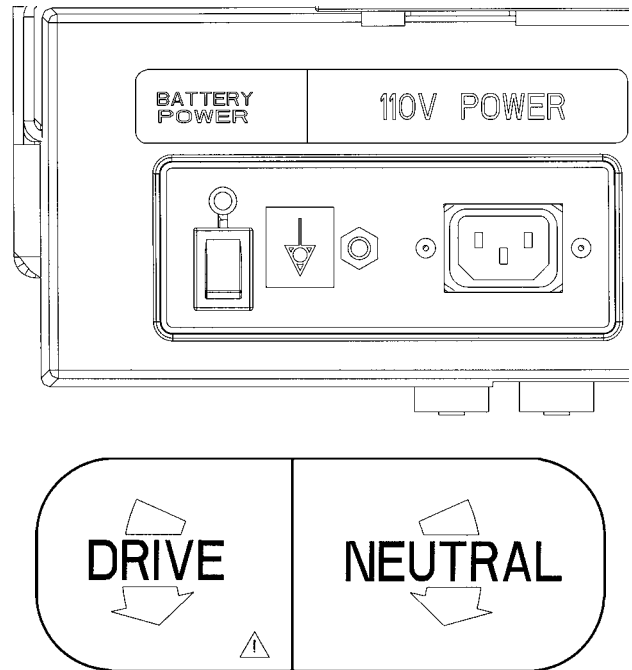

WARNING

USE CAUTION while maneuvering the unit with the drive wheel activated. Always ensure there are no obstacles near the unit while the drive wheel is activated. Injury to the patient, user or bystanders or damage to the unit or surrounding equipment could occur if the unit collides with an obstacle.

USE CAUTION when transporting the unit down halls, through doors, in and out of elevators, etc. Damage to the siderails or other parts of the unit could occur if the unit comes in contact with walls or door frames.

5. Grasp the drive handle at the two raised grip areas. Squeeze either of the motion release switches (A) located under the handle to enable the movement of the drive wheel. Either or both switches will enable movement but both switches must be released to stop movement.

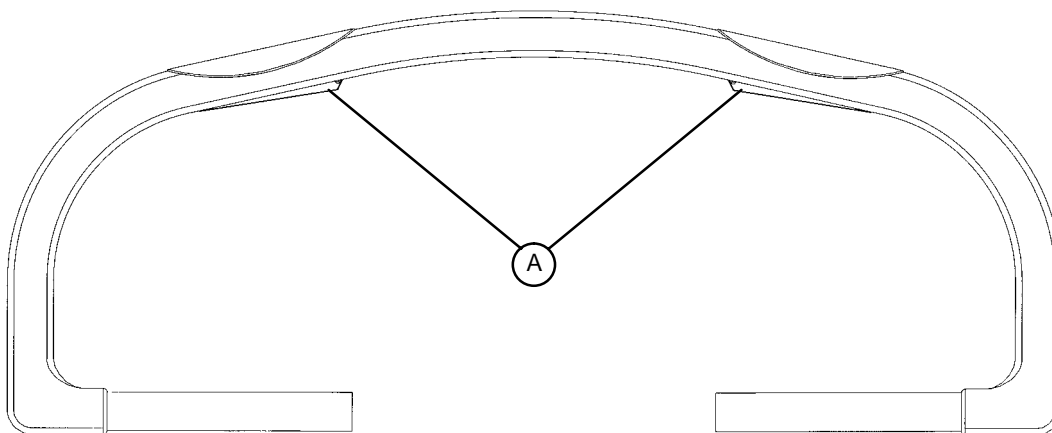

Base Operation Guide

DRIVE WHEEL OPERATION (CONTINUED)

6. While continuing to squeeze the switch(es), push the handle away from you or pull the handle toward you to initiate motion in that direction. The forward speed will increase proportionally to the distance the drive handle is moved. I.E. the farther forward the drive handle is pushed, the faster the unit will move. **To stop motion, remove your hands from the switches and the handle.**

NOTE

The drive wheel does not pivot. The unit cannot be moved directly sideways with the drive wheel engaged. With the drive wheel pedal in the neutral position and the unit's brakes released, the unit can be moved in any direction including sideways.

Driving a Zoom®-equipped unit over liquids or slick surfaces could decrease the traction of the drive wheel.



WARNING

Put the drive wheel in the neutral position and release the brakes before pushing the unit manually. Do not attempt to push the unit manually with the drive wheel engaged. The unit will be difficult to push and injury could result.



CAUTION

When attaching equipment to the frame, ensure it will not impede normal operation. For example: hooks on hanging equipment must not actuate control buttons, equipment must not hide the nurse call button, etc.

Litter Operation Guide

CPR EMERGENCY RELEASE USAGE

If the Back and/or Knee is raised and quick access to the patient is needed, squeeze one of the two red emergency release handles, located under the litter top at the head section on either side of the unit, and the Back and Knee will lower to a flat position. The handle can be released at any time to stop the Back from lowering.

WARNING

Assistance is required to lower the Back if the angle of the Back is greater than 80° when the CPR emergency release is activated. Attempting to lower the Back in this position without assistance may result in injury to the operator.

CPR BOARD USAGE

The CPR board is stored on the head board. To remove it, pull it away from the head board and lift it out of the storage position. The head board can also be removed and used as an emergency CPR board.

FOLEY BAG HOOKS USAGE

The standard Foley bag hooks are found at three locations on both sides of the frame: under the frame rail below the seat section, below the thigh section and at the extreme foot end of the frame. The patient weight reading on the scale system will not be affected when the Foley bag hooks are used.

Siderail Operation Guide

POSITIONING SIDERAILS

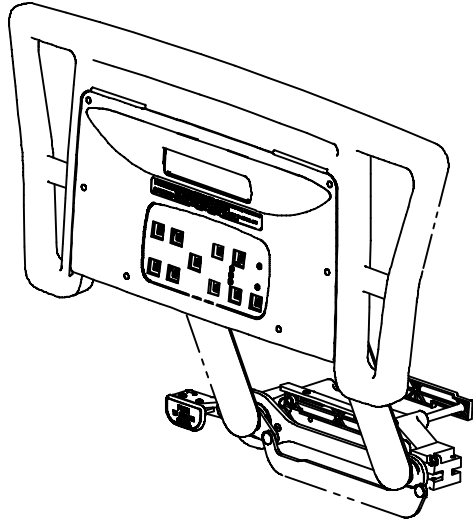

NOTE

The head end siderails can be locked at two positions (intermediate & full). The foot end siderails lock in the full up position only.

- All four siderails can slide away to the side of the bed when not in use. To remove the rail from the lowered position, grasp the handle on the siderail panel and pull outward.
- To engage the head end siderail, grasp the rail and swing it upward to full height. When the siderail is being raised, it does not lock in the intermediate position. To lower the siderail, push in the yellow release handle and rotate the siderail until it locks in the intermediate position. To lower the siderail fully, push in the yellow release handle again and rotate the siderail until it is completely lowered.

NOTE

To activate the siderail bypass mechanism, the rail must be fully lowered. If the rail is not completely lowered, the siderail will lock in the intermediate position when it is raised. There is no intermediate level and thus no bypass function on the foot end siderails.

- The same procedure is used to raise and lower the foot end siderail, however, the siderail swings toward the foot end of the frame instead of the head end. There is no intermediate position for the foot end siderails.

WARNING

When raising the siderails, listen for the "click" that indicates the siderail has locked in the up position. Pull firmly on the siderail to ensure it is locked into position. Siderails are not intended to be a patient restraint device. It is the responsibility of attending medical personnel to determine the degree of restraint and the siderail positioning necessary to ensure a patient will remain safely in bed.

CAUTION

The siderails are not intended to be used as a pushing device. Damage to the siderails could occur. The use of a mattress overlay may reduce the effectiveness of the siderail.

Siderail Operation Guide

SIDERAIL CONTROL PANEL LIGHTS

- The head end siderails are equipped with lights to illuminate the siderail control buttons and the nurse call switch. The lights are activated at the foot board control panel.
- There are three settings for the intensity of the siderail control lights: low, medium and high. When all the siderail lights are off, push the siderail control light button on the foot board once to turn on both the control lights and the nurse call indicator light. Push the button again to change the siderail control lights from low to medium setting, and again to change to the high setting. (The intensity of the nurse call indicator light does not change.)
- When all the siderail lights are on, pushing the button once will turn off only the siderail control lights and pushing it again will turn off the nurse call indicator light (see control panel guide, [page 18](#)).



CAUTION

The intent of the nurse call indicator light on the siderails is to help the patient locate the button for contacting the nurse station. Turning this light off will compromise this ability, especially in a darkened room.

Siderail Operation Guide

OUTSIDE SIDERAIL FUNCTION GUIDE

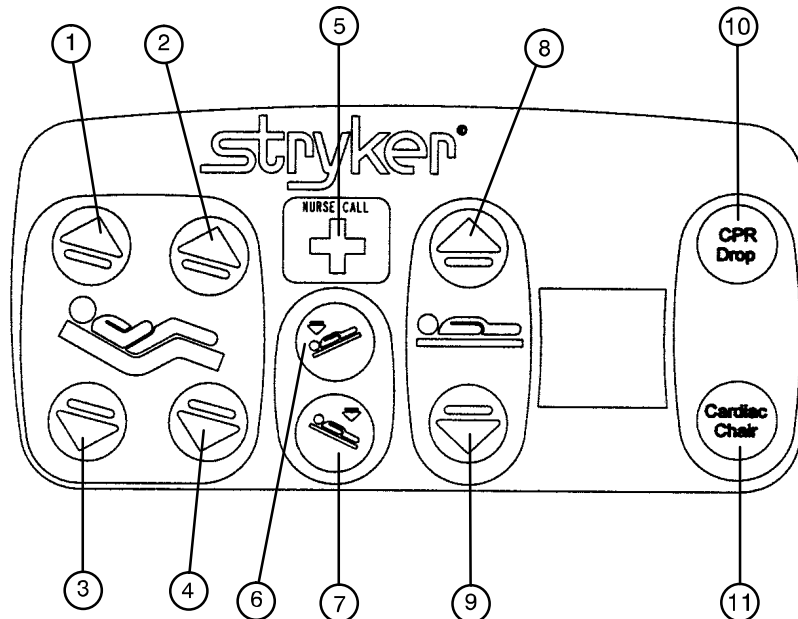

1. Press to raise back section.
2. Press to raise knee section.
3. Press to lower back section.
4. Press to lower knee section.
5. Press to activate nurse call. ► This function is optional equipment.
6. Press to lower the head end (Trendelenburg).
7. Press to lower the foot end (Reverse Trendelenburg).
8. Press to raise the litter. If your bed is equipped with the enhanced height option, continue to hold the button an additional 5 seconds after the first stop. The litter will raise an additional 2 inches.
9. Press to lower the litter.
► The following functions are optional equipment.
10. Press to activate emergency CPR positioning. The Back will lower to flat, the Knee will lower to flat, the litter will level from Trendelenburg/reverse Trendelenburg, and the litter will lower to full down.
11. Press to activate Cardiac Chair positioning. The Knee will raise, the Back will raise or lower to 51° and the litter will tilt to -10° reverse Trendelenburg (foot end down). Release the button to stop bed movement. Hold the button until movement stops to complete the function.

CAUTION

When attaching equipment to the frame, ensure it will not impede normal operation. For example: hooks on hanging equipment must not actuate control buttons, equipment must not hide the nurse call button, etc.

WARNING

The power save mode is activated after one hour on battery power with no motion release switch activation. Functions including Bed Exit, scale and motion will cease to operate when the unit enters the power save mode. Injury to the patient could occur if proper patient monitoring protocol is not observed.

Siderail Operation Guide

INSIDE SIDERAIL FUNCTION GUIDE

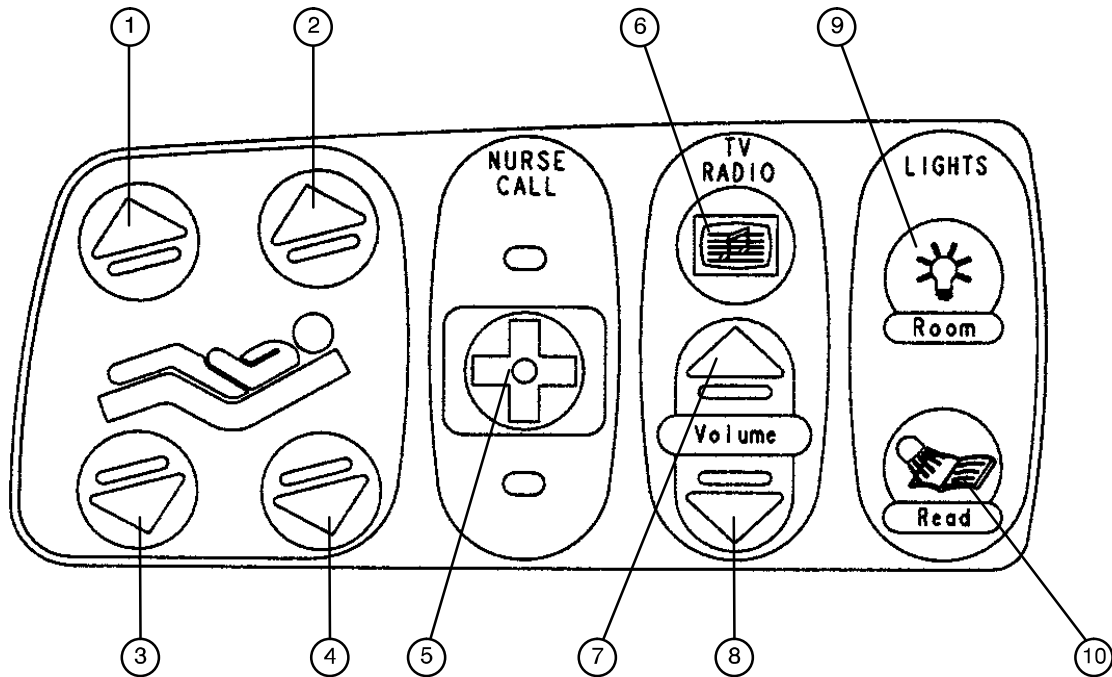

1. Press to raise knee section.
2. Press to raise back section.
3. Press to lower knee section.
4. Press to lower back section.

► The following functions are optional equipment.

5. Press to activate the nurse call.
6. Press to turn on the TV or radio. Press again to change TV channels and to turn off the TV.
7. Press to increase the TV or radio volume.
8. Press to decrease the TV or radio volume.
9. Press to turn on the room lights. Press again to turn off.
10. Press to turn on the reading light. Press again to turn off.

CAUTION

When attaching equipment to the frame, ensure it will not impede normal unit operation. For example: hooks on hanging equipment must not actuate control buttons, equipment must not hide the nurse call button, etc.

Head End Control Panel Operation Guide

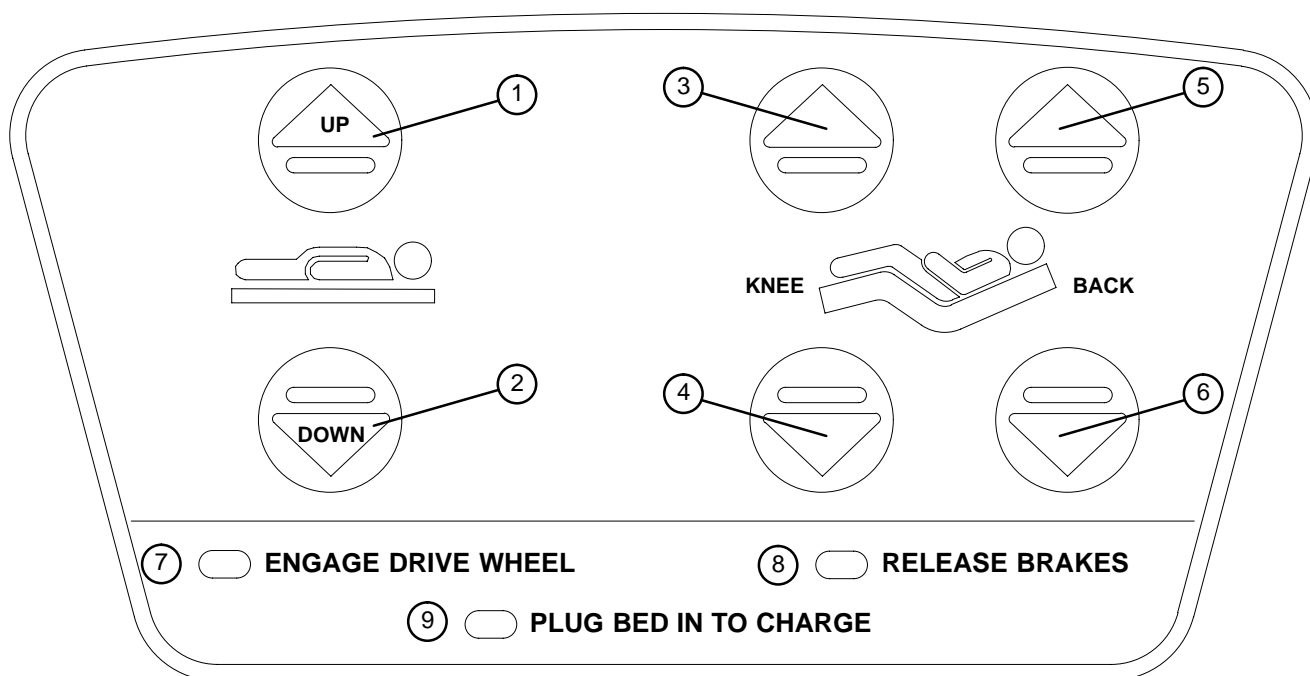

1. Press and hold to raise the litter. If your bed is equipped with the enhanced height option, continue to hold the button an additional 5 seconds after the first stop. The litter will raise an additional 2 inches.
2. Press and hold to lower the litter.
3. Press to raise the Knee section.
4. Press to lower the Knee section.
5. Press to raise the Back section.
6. Press to lower the Back section.
7. The "Engage Drive Wheel" LED will be illuminated whenever the battery power switch is on and the drive wheel pedal is in the neutral position. The light will go off when the drive wheel is in the drive position.
8. The "Release Brakes" LED will be illuminated whenever the bed's brakes are engaged while the battery power switch is on. The light will go off when the brakes are disengaged.
9. The "Plug Bed In To Charge" LED will be illuminated while the battery power switch is on if the battery level is low. Plug the bed power cord into the wall socket to charge the batteries.

Foot Board Control Panel Operation Guide

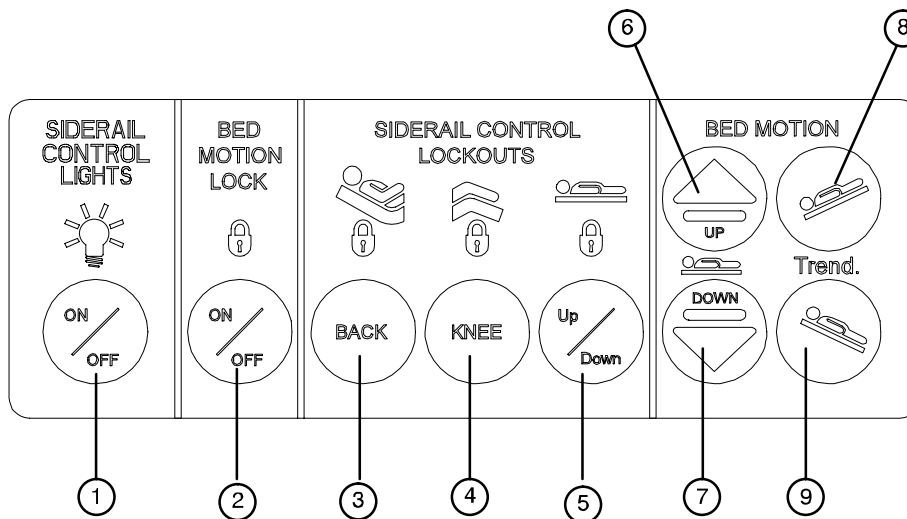

1. Press repeatedly for low, medium and high settings for the siderail control lights. Continue to press this switch to turn off the siderail control lights (see [page 14](#)) and the nurse call indicator light.
2. Press to lock out all motion controls on the siderails. Press again to unlock.
3. Press to lock out the Back motion control on the siderails. Press again to unlock.
4. Press to lock out the Knee motion control on the siderails. Press again to unlock.
5. Press to lock out the up/down motion controls on the siderails. Press again to unlock.
6. Press to raise the litter. Continue to hold the button an additional 5 seconds after the first stop. The litter will raise an additional 2 inches.
7. Press to lower the litter.
8. Press to lower the head end (Trendelenburg).
9. Press to lower the foot end (Reverse Trendelenburg).

CAUTION

When attaching equipment to the frame, ensure it will not impede normal operation. For example: hooks on hanging equipment must not actuate control buttons, equipment must not hide the nurse call button, etc.

Because individual beds may have different options, foot boards should not be moved from one bed to another. Interchanging foot boards between beds could result in unpredictable bed operation.

WARNING

The power save mode is activated after one hour on battery power with no motion release switch activation. Functions including Bed Exit, scale and motion will cease to operate when the unit enters the power save mode. Injury to the patient could occur if proper patient monitoring protocol is not observed.

Foot Board Control Panel Operation Guide

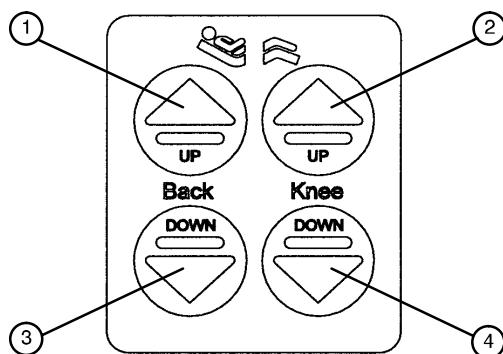

1. Press to raise back section.
2. Press to raise knee section.
3. Press to lower back section.
4. Press to lower knee section.

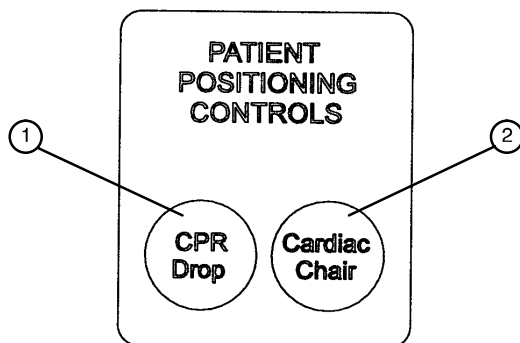

1. Press to activate the emergency CPR function. The Back will lower to flat, the Knee will lower to flat, the litter will level from Trendelenburg/reverse Trendelenburg, and the litter will lower to full down.
2. Press to activate the Cardiac Chair function. The Knee will raise, the Fowler will raise or lower to approximately 52° and the bed will tilt to approximately -12° reverse Trendelenburg (foot end down) or -14° if the bed has the enhanced height option. Release the button to stop bed movement: hold the button until movement stops to complete the function.

Foot Board Operation Guide

CHAPERONE® BED EXIT (OPTIONAL EQUIPMENT)

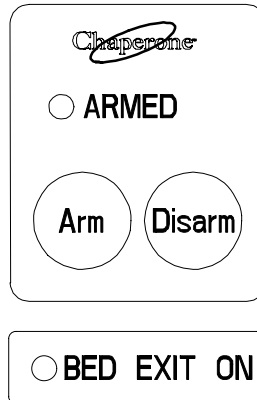

For beds with a scale system:

NOTE

If the scale system is in use, it will switch to "off" when the "ARM" key is pressed.

1. Before putting the patient on the bed, the scale system must be zeroed for the Bed Exit System to function properly (see [page 26](#) for instructions on zeroing the scale system).
2. Put the patient on the bed and push the "ARM" key to activate the Bed Exit function. The "ARMED" light will come on.
3. To deactivate Bed Exit, push the "DISARM" key. The "ARMED" and "BED EXIT ON" lights will turn off.

For beds without a scale system:

1. Before putting the patient on the bed, press and hold the "ARM" and the "DISARM" keys together until the "ARMED" light begins to flash.
2. Release the "ARM" and the "DISARM" keys and do not touch the bed until the "ARMED" light stops flashing.
3. Put the patient on the bed and push the "ARM" key to activate the Bed Exit function. The "ARMED" light will come on.
4. To deactivate Bed Exit, push "DISARM". The "ARMED" and "BED EXIT ON" lights will turn off.

WARNING

The Bed Exit System is intended only to aid in the detection of a patient exiting the bed. It is NOT intended to replace patient monitoring protocol. It signals when a patient is about to exit. Adding or subtracting objects from the bed after arming the bed exit system may cause a reduction in the sensitivity of the bed exit system. To avoid possible injury and to assure proper operation when using a powered mattress replacement system such as XPRT, do not initialize ("arm") bed exit with Percussion, Vibration, Rotation or Turn-Assist active. The patient motion and position resulting from a dynamic therapy mattress may adversely affect bed exit system performance.

Foot Board Operation Guide

CHAPERONE® BED EXIT WITH ZONE CONTROL (OPTIONAL EQUIPMENT)

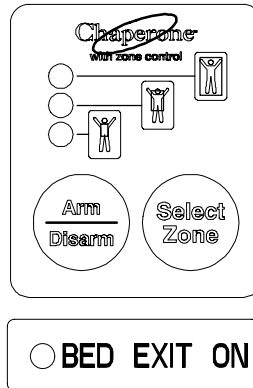

For beds with a scale system:

NOTE

If the scale system is in use, it will switch to "off" when Bed Exit is armed.

1. Before putting the patient on the bed, the scale system must be zeroed for the Bed Exit System to function properly (see [page 26](#) for instructions on zeroing the scale system).
2. Put the patient on the bed and push and release the "ARM/DISARM" key (top light will come on).
3. The Bed Exit system with Zone Control will automatically select the first zone. To change the zone, push and hold the "SELECT ZONE" key until the light indicating the desired zone comes on.
4. To deactivate Bed Exit, push the "ARM/DISARM" key. The selected zone light and "BED EXIT ON" lights will turn off.

For beds without a scale system:

1. Before putting the patient on the bed, press and hold the "ARM/DISARM" and the "SELECT ZONE" keys together for 5 seconds. The top light will begin to flash.
2. Release the "ARM/DISARM" and the "SELECT ZONE" keys and do not touch the bed until the top light stops flashing.
3. Put the patient on the bed and push and release the "ARM/DISARM" key (top light will come on).
4. The Bed Exit system with Zone Control will automatically select the first zone. To change the zone, push and hold the "SELECT ZONE" key until the light indicating the desired zone comes on.
5. To deactivate Bed Exit, push the "ARM/DISARM" key. The selected zone light and "BED EXIT ON" light will turn off.

WARNING

To avoid possible injury and to assure proper operation when using a powered mattress replacement system such as XPRT, do not initialize ("arm") bed exit with Percussion, Vibration, Rotation or Turn-Assist active. The patient motion and position resulting from a dynamic therapy mattress may adversely affect bed exit system performance.

Foot Board Operation Guide

CHAPERONE® BED EXIT WITH ZONE CONTROL (CONTINUED)

CHAPERONE® ZONE SETTINGS

The first zone (top indicator light) is the traditional Bed Exit zone. The patient can move around the bed freely but cannot fully exit the bed or the alarm will sound.

The second zone (middle indicator light) is more restrictive than the first zone. When the zone is selected, the bed measures the location of the patient's center of gravity. If the patient's center of gravity moves from the original location more than 6.5 inches to either side or 13 inches toward the head or foot, an alarm will sound.

The third zone (bottom indicator light) is the most restrictive zone. When the zone is selected, the bed measures the location of the patient's center of gravity. If the patient's center of gravity moves from the original location more than 1 inch to either side or 1 inch toward the head or foot, an alarm will sound.

NOTE

All zone dimensions are $\pm .5$ inches.

Foot Board Control Panel Operation Guide

LED DISPLAY PANEL GUIDE

The LED Display Panel is located at the foot end of the frame, below the Control Panel.



"POWER" – will light when the power cord is plugged into the wall receptacle or the battery power switch is on. Will blink if the 9V Nurse Call battery needs to be replaced.

"BED MOTION LOCKED" – will light when the Bed Motion Lock has been activated.

FUNCTION LOCKOUT SYSTEM

1. To lock out all motion switches on the unit, press the "ON/OFF" switch in the "Siderail Control Lockouts" module. The "padlock" symbol on the control panel will be lighted when that function is locked out.
2. To lock out the movement functions on the siderails and prevent the patient from changing the positioning of the frame, press the "BACK" or "KNEE" switch in the "Siderail Control Lockouts" module. The "padlock" symbol on the control panel will be lighted when that function is locked out.
3. To lock out the up/down motion on the siderails, press the Up/Down switch in the "Siderail Control Lockouts" module. The "padlock" symbol on the control panel will be lighted when that function is locked out.

CAUTION

The lockout buttons on the foot board lock the Fowler, Gatch and Bed Up/Down functions and prevent motion of the bed. It is the responsibility of attending medical personnel to determine whether these functions should be locked and to use the buttons accordingly.

Foot Board Control Panel Operation Guide

SCALE SYSTEM CONTROL PANEL GUIDE (OPTIONAL EQUIPMENT)

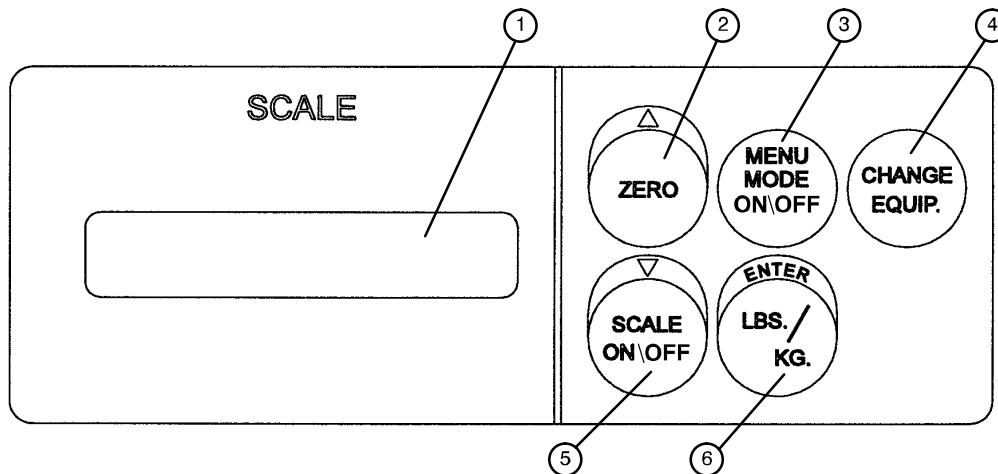

1. LCD – displays patient weight. Trendelenburg angle is displayed when the scale is not active.
2. Press to zero scale system (see [page 26](#)). Also press to scroll while Menu Mode is active.
3. Press to enter and exit the Menu Mode.
4. Press when adding or removing equipment on the frame (see [page 27](#)).
5. Press to turn scale system on and off. Also press to scroll while Menu Mode is active.
6. Press to change weight from pounds to kilograms or back (see [page 28](#)). Also press while using the Menu Mode.
7. Press to display the Trendelenburg or Fowler angle (see [page 28](#)).

NOTE

If weight is displayed, SCALE ON/OFF must be pressed to turn off the scale before the Trend. or Fowler angle will display.



CAUTION

Scale function may be affected by siderail/caster interference. With the litter fully lowered or lowered in Reverse Trendelenburg, the siderails tucked under the litter in the storage position and the casters turned, there is the potential for interference between the siderail and the caster. Raise the siderails when lowering the litter to the full down position to prevent the interference from causing the bed's scale system to weigh inaccurately. The power save mode is activated after one hour on battery power with no motion release switch activation. Functions including Bed Exit, scale and motion will cease to operate when the unit enters the power save mode. Injury to the patient could occur if proper patient monitoring protocol is not observed.

WARNING

To avoid possible injury and to assure proper operation when using a powered mattress replacement system such as XPRT:

- Confirm proper scale system operation following mattress installation. For best results, secure the mattress power cord to prevent damage to the cord and interference with the bed frame and the scale system.
- Do not zero bed scales or weigh patient with Percussion, Vibration, Rotation or Turn-Assist active. Patient motion and position resulting from the dynamic therapy mattress may adversely affect scale system performance.

Foot Board Control Panel Operation Guide

SCALE SYSTEM CONTROL PANEL GUIDE (CONTINUED)

For more detailed operating instructions see the following:

1. Preparing The Unit For Patient Stay/Zeroing the Scale System – [page 26](#)
2. Activating the Scale System and Displaying Patient Weight – [page 26](#)
3. Adding or Removing Items During a Patient's Stay – [page 27](#)
4. Displaying Trendelenburg or Fowler Angle – [page 28](#)
5. Converting the Patient's Weight – [page 28](#)
6. Viewing Patient Weight In Gain/Loss Mode – [page 30](#)
7. Changing the Numerical Value Of Displayed Weight – [page 31](#)

Scale System Usage

PREPARING THE BED FOR PATIENT STAY/ZEROING THE SCALE SYSTEM

NOTE

Do not zero the bed while a patient is in bed. If this should occur, remove the patient and zero the bed again. If Bed Exit is armed, it must be disarmed before the scales can be zeroed.

- Prepare the bed for the patient's stay by adding/removing linens, pillows, etc.

- Press and release  The scale monitor will read:
“LET GO FOR SCALE”
“WEIGHING”
“XXX.X LB”

- Press and hold  The scale monitor will read:
“HOLD TO ZERO WT.”
“RELEASE TO ZERO”

- Release  The scale monitor will now read:
“DO NOT TOUCH BED”
“0.0 LB”

The bed is now ready for the patient.

NOTE

If there is a problem with a load cell or another component of the scale system, the system will try to zero for 30 seconds, and the scale monitor will read:

“UNABLE TO ZERO”
“TRY AGAIN”

If the problem continues, after 3 attempts at zeroing, the scale system will lock and the scale monitor will read:

“Scale Sys. Error”
“Call for service”

Unplug the bed power cord from the wall socket and plug it back in. If the problem continues, call a service technician.

ACTIVATING THE SCALE SYSTEM AND DISPLAYING PATIENT WEIGHT

- Press and release  The scale monitor will read:
“LET GO FOR SCALE”
“WEIGHING”
“XXX.X LB”

Scale System Usage

ADDING OR REMOVING ITEMS DURING A PATIENT'S STAY

- If it is necessary to add or remove items (monitors, pumps, etc.) during the patient's stay, press and re-

lease  to activate the scale system. After the scale monitor reads: "XXX.X LB", press and hold

 The scale monitor will read:

"HOLD TO START"

"RELEASE TO START"

- Release  The scale monitor will read:

"DO NOT TOUCH BED"

"ADD/REMOVE EQUIP."

- Add or remove the equipment and press  The scale monitor will read:

"RELEASE TO FIN."

- Release  The scale monitor will read:

"DO NOT TOUCH BED"

"XXX.X LB"

The weight displayed will be that of the patient only.

- If the CHANGE EQUIPMENT function is started but not finished, after 50 seconds the monitor will read:
"HIT CH. EQ. TO END"

- Press  The scale monitor will read:

"RELEASE TO FIN."

- Release  The scale monitor will read:

"DO NOT TOUCH BED"

"XXX.X LB"

Scale System Usage

DISPLAYING TRENDLENBURG OR FOWLER ANGLE

- If scale system is on, press and hold  The scale monitor will read:
“EXIT SCALE”
“FOWLER ANGLE X°” (default setting)
or
“TREND ANGLE X°”
- If scale system is not active, the scale monitor will read:
“FOWLER ANGLE X°” (default setting)
or
“TREND ANGLE X°”

CONVERTING THE PATIENT'S WEIGHT

- Press and release  The scale monitor will read:
“WEIGHT NOW KGS”
“XXX.X KG”
- Repeat the procedure to return to pounds. The display will read:
“WEIGHT NOW LBS”
“XXX.X LB”
- If the unit of measurement has been locked, the display will read:
“UNITS ARE LOCKED”

A service technician must be called to unlock the unit of measurement.

Scale System Usage

DISPLAYING THE WEIGHT LOG



- To display a list of the previous 10 weight readings, press  to activate the scale system. The scale monitor will read:

“LET GO FOR SCALE”

“XXX.X LB”

- Press  to enter the Menu Mode. The scale monitor will read:

“▲▼ FOR OPTIONS”



- Press  or  to scroll through the menu options. The scale monitor will read:

“SHOW WEIGHT LOG”

“PUSH ENTER”

- Press  The scale monitor will read:

“▲▼ WEIGHT LOG”

- Press  or  to scroll through the weight log.

“1. 0.0 LB”

- A weight reading is logged each time the  button is pressed and the bed is in the scale mode for at least 15 seconds.

The first weight reading displayed (1.) is the most recent. If the change in the patient's weight since the last reading was taken is less than .2 pounds, the log will not update. Zeroing the scale system clears the weight log.

Scale System Usage

VIEWING PATIENT WEIGHT IN GAIN/LOSS MODE

- To view the patient's weight and to begin totaling the amount of weight the patient has gained or lost, press





to activate the scale system. The scale monitor will read:

"LET GO FOR SCALE"

- Press  to enter the Menu Mode. The scale monitor will read:

"▲▼ FOR OPTIONS"

- Press  or  to scroll through the menu options. The scale monitor will read:

"START GAIN/LOSS"

"PUSH ENTER"



- Press  The scale monitor will read:

"DO NOT TOUCH BED"

"XXX.X LB G XX.X"

- To exit Gain/Loss mode, press  to enter the Menu Mode. The scale monitor will read:

"▲▼ FOR OPTIONS"

- Press  or  to scroll through the menu options. The scale monitor will read:

"QUIT GAIN/LOSS"

"PUSH ENTER"

- Press  The scale monitor will read:

"XXX.X LB"

Scale System Usage

CHANGING THE NUMERICAL VALUE OF DISPLAYED WEIGHT

- To decrease the numerical value of the displayed weight, press  to activate the scale system.



The scale monitor will read:

“LET GO FOR SCALE”

“XXX.X LB”

- Press  to enter the Menu Mode. The scale monitor will read:

“▲▼ FOR OPTIONS”



- Press  or  to scroll through the menu options. The scale monitor will read:

“CHNG. PTNT. WGT.”

“PUSH ENTER”

- Press  The scale monitor will read:

“HOLD ▲ TO INC.
▼ TO DEC.”

- Press  to decrease the displayed weight or  to increase the displayed weight.

- Once the desired weight is displayed, press  The scale monitor will read:

“XXX.X LB”

NOTE

If one of the load cells is malfunctioning or overloaded, the scale monitor will read:

“Scale Sys. Error”

“Call for service”

Call a service technician.

Optional Pendant Operation

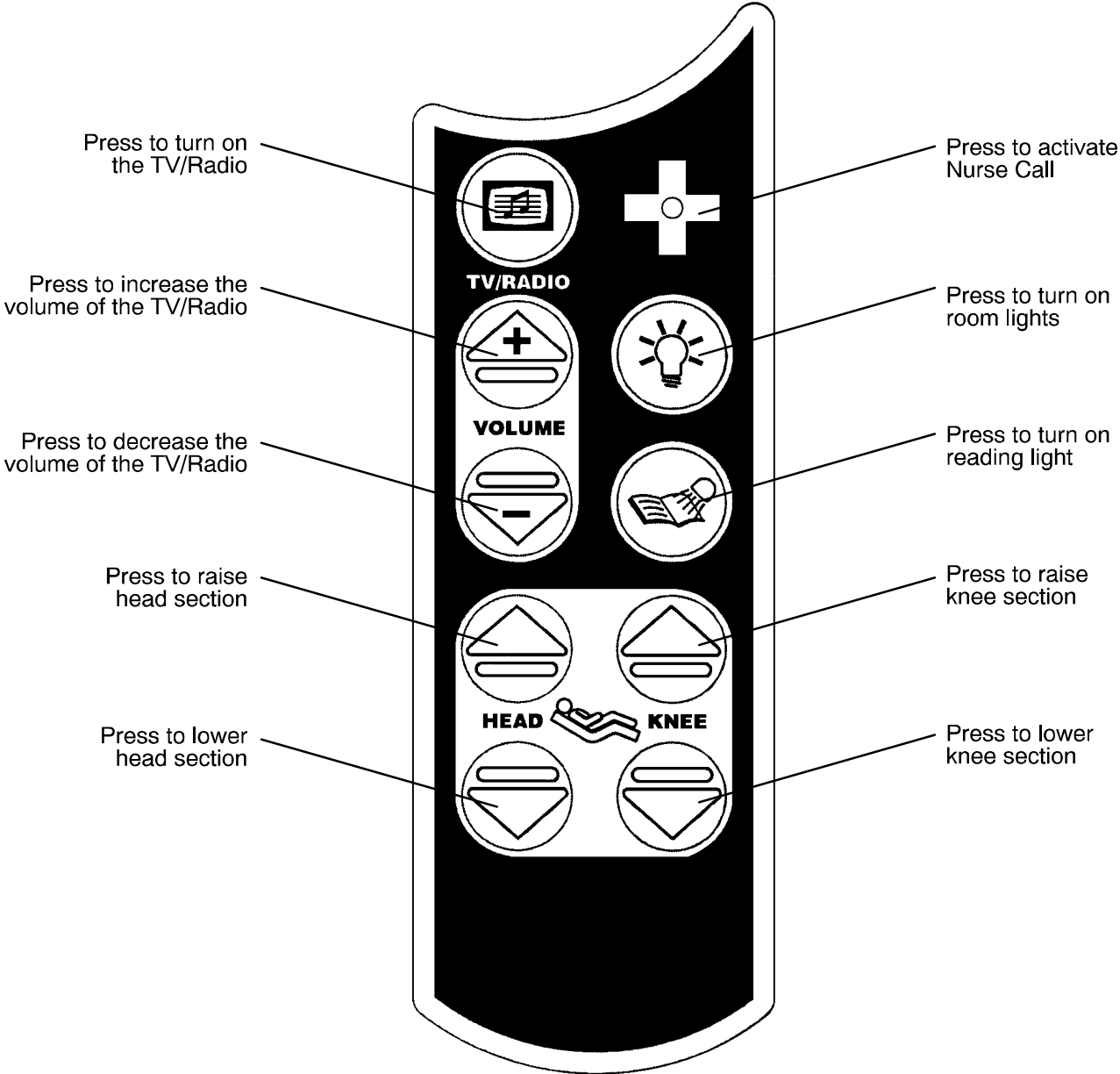

Operation Guide

OPERATING IV POLES

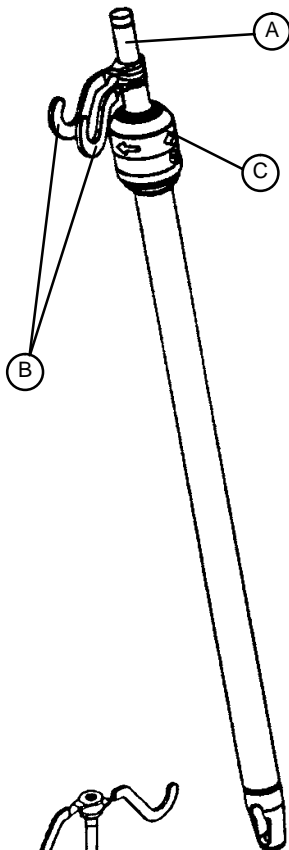

To use the 2-Stage Permanently Attached IV pole:

NOTE

The 2-stage permanently attached IV pole is an option and may have been installed at either the head, foot or both ends. The choice was made at the time the unit was purchased.

1. Lift and pivot the pole from the storage position and push down until it rests in the receptacle.
2. To raise the height of the pole, pull up on the telescoping portion (A) until it locks into place at its fully raised position.
3. Rotate the IV hangers (B) to desired position and hang IV bags.
4. To lower the IV pole turn the latch (C) clockwise until section (A) lowers.



CAUTION

The weight of the IV bags should not exceed 40 pounds.



WARNING

To avoid pinching your fingers, place the IV pole in the upright position before using the drive handle.

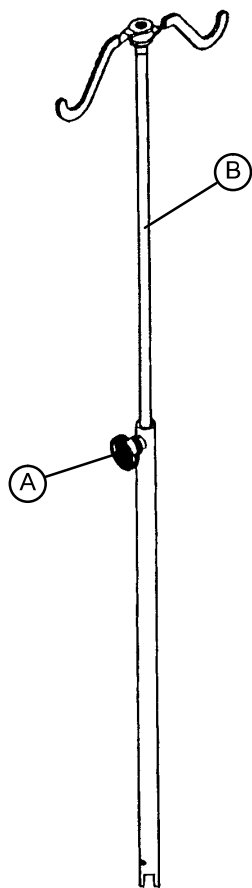

To use the "Removable" IV pole:

1. Install the pole at any of the four receptacles on the bed top (located on all four corners of the frame.)
2. To raise the height of the pole, turn knob (A) counterclockwise and pull up on the telescoping portion (B) of the pole and raise it to the desired height.
3. Turn knob (A) clockwise to tighten the telescoping portion in place.



CAUTION

The weight of the IV bags should not exceed 40 pounds.

Preventative Maintenance

WARNING

Service only by qualified personnel. Refer to the maintenance manual.
Ensure the power cord is unplugged and battery power switch is turned to the off position before servicing.

NURSE CALL BATTERY

To prevent a low battery condition when the power cord is not plugged in, position the cord out switch at the head end to the off position. The switch is identified by the label shown below. If the switch is not positioned as shown below and the power cord and pendant cord are unplugged, the life of the back-up battery will be significantly reduced.

If the foot board POWER LED (located on the outside of both siderails) is flashing, the Nurse Call battery needs to be replaced. The battery is located on the patient's left side under the litter frame. No tools are required to replace the battery. Unplug the power cord from the wall socket and replace the battery. After replacing the battery, verify the foot board POWER LED is no longer flashing. Properly dispose of the old battery in accordance with local regulations.

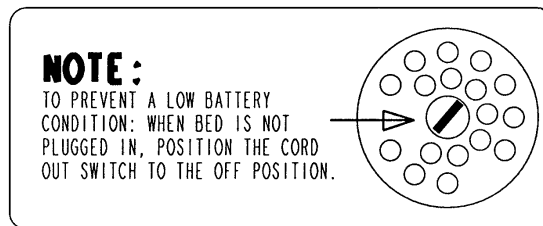

MAIN POWER CIRCUIT BREAKER

In the event of a loss of electric function, unplug the power cord from the wall socket and reset the circuit breaker(s) located under the head end of the litter on the patient's left side. Plug the power cord into a properly grounded wall receptacle and follow the set-up procedures listed on [page 6](#).

BATTERY CHARGER CIRCUIT BREAKER

If the battery charger circuit breaker(s) located under the litter on the patient's head end, left side are tripped, refer to the troubleshooting section of the maintenance manual.

Cleaning

CLEANING

Hand wash all surfaces of the bed with warm water and mild detergent. DRY THOROUGHLY. Do not steam clean or hose off the Zoom Bed. Do not immerse any part of the bed. Some of the internal parts of the bed are electric and may be damaged by exposure to water.

Suggested cleaners for bed surfaces:

Quaternary Cleaners (active ingredient – ammonium chloride)

Phenolic Cleaners (active ingredient – o-phenyl phenyl)

Chlorinated Bleach Solution (5.25% – less than 1 part bleach to 100 parts water)

Avoid over-saturation and ensure the product does not stay wet longer than the chemical manufacturer's guidelines for proper disinfecting.

CAUTION

SOME CLEANING PRODUCTS ARE CORROSIVE IN NATURE AND MAY CAUSE DAMAGE TO THE PRODUCT IF USED IMPROPERLY. If the products described above are used to clean Stryker patient care equipment, measures must be taken to insure the beds are wiped with clean water and thoroughly dried following cleaning. Failure to properly rinse and dry the beds will leave a corrosive residue on the surface of the bed, possibly causing premature corrosion of critical components. Failure to follow the above directions when using these types of cleaners may void this product's warranty.

For mattress cleaning instructions, please see the tag on the mattress, or contact the mattress manufacturer.

Clean Velcro® AFTER EACH USE. Saturate Velcro® with disinfectant and allow disinfectant to evaporate. (Appropriate disinfectant for nylon Velcro® should be determined by the hospital.)

Preventative Maintenance

CHECKLIST

- All fasteners secure
- Engage brake pedal and push on the frame to ensure all casters lock securely
- Engage drive wheel and ensure it is operating properly
- Motion release switches working properly
- Confirm Head End Control Panel functionality
- Confirm battery powered functionality
- Siderails move, latch and stow properly
- All functions on siderails working properly (including LED's)
- CPR release working properly
- Optional foot prop intact and working properly
- I.V. pole working properly
- Foley bag hooks intact
- Chart rack intact and working properly
- CPR board not cracked or damaged and stores properly
- No cracks or splits in head and foot boards
- All functions on footboard working properly (including LED's)
- No rips or cracks in mattress cover
- Scale and Bed Exit system calibrated properly
- Power cord not frayed
- No cables worn or pinched
- All electrical connections tight
- All grounds secure to the frame
- Ground impedance not more than 100 milliohms
- Current leakage not more than 300 microamps
- Apply grease to litter grease points
- Ensure ground chains are clean, intact, and have at least two links touching the floor.

Unit Serial No. _____ _____
 _____ _____
 _____ _____
 _____ _____

Completed By: _____ Date: _____

Warranty

Limited Warranty:

Stryker Medical Division, a division of Stryker Corporation, warrants to the original purchaser that its products should be free from defects in material and workmanship for a period of one (1) year after date of delivery. Stryker's obligation under this warranty is expressly limited to supplying replacement parts and labor for, or replacing, at its option, any product which is, in the sole discretion of Stryker, found to be defective. Stryker warrants to the original purchaser that the frame and welds on its beds will be free from structural defects for as long as the original purchaser owns the bed. If requested by Stryker, products or parts for which a warranty claim is made shall be returned prepaid to Stryker's factory. Any improper use or any alteration or repair by others in such manner as in Stryker's judgement affects the product materially and adversely shall void this warranty. Any repair of Stryker products using parts not provided or authorized by Stryker shall void this warranty. No employee or representative of Stryker is authorized to change this warranty in any way.

Stryker Medical beds are designed for a 15 year expected life under normal use conditions and appropriate periodic maintenance as described in the maintenance manual for each device.

This statement constitutes Stryker's entire warranty with respect to the aforesaid equipment. STRYKER MAKES NO OTHER WARRANTY OR REPRESENTATION, EITHER EXPRESSED OR IMPLIED, EXCEPT AS SET FORTH HEREIN. THERE IS NO WARRANTY OF MERCHANTABILITY AND THERE ARE NO WARRANTIES OF FITNESS FOR ANY PARTICULAR PURPOSE. IN NO EVENT SHALL STRYKER BE LIABLE HEREUNDER FOR INCIDENTAL OR CONSEQUENTIAL DAMAGES ARISING FROM OR IN ANY MANNER RELATED TO SALES OR USE OF ANY SUCH EQUIPMENT.

To Obtain Parts and Service:

Stryker products are supported by a nationwide network of dedicated Stryker Field Service Representatives. These representatives are factory trained, available locally, and carry a substantial spare parts inventory to minimize repair time. Simply call your local representative, or call Stryker Customer Service at (800) 327-0770.

Service Contract Coverage:

Stryker has developed a comprehensive program of service contract options designed to keep your equipment operating at peak performance at the same time it eliminates unexpected costs. We recommend that these programs be activated *before* the expiration of the new product warranty to eliminate the potential of additional equipment upgrade charges.

A SERVICE CONTRACT HELPS TO:

- Ensure equipment reliability
- Stabilize maintenance budgets
- Diminish downtime
- Establish documentation for JCAHO
- Increase product life
- Enhance trade-in value
- Address risk management and safety

Warranty

Stryker offers the following service contract programs:

SPECIFICATIONS	GOLD	SILVER	PM* ONLY
Annually scheduled preventative maintenance	X		X
All parts,** labor, and travel	X	X	
Unlimited emergency service calls	X	X	
Priority one contact; two hour phone response	X	X	X
Most repairs will be completed within 3 business days	X	X	
JCAHO documentation	X	X	X
On-site log book w/ preventative maintenance & emergency service records	X		
Factory-trained Stryker Service Technicians	X	X	X
Stryker authorized parts	X	X	X
End of year summary	X		
Stryker will perform all service during regular business hours (9-5)	X	X	X

* Replacement parts and labor for products under PM contract will be discounted.

** Does not include any disposable items, I.V. poles (except for Stryker HD permanent poles), mattresses, or damage resulting from abuse.

Stryker Medical also offers *personalized* service contracts.

Pricing is determined by age, location, model and condition of product.

For more information on our service contracts, please call your local representative or call (800) 327-0770 (option #2).

Return Authorization:

Merchandise cannot be returned without approval from the Stryker Customer Service Department. An authorization number will be provided which must be printed on the returned merchandise. Stryker reserves the right to charge shipping and restocking fees on returned items.

SPECIAL, MODIFIED, OR DISCONTINUED ITEMS NOT SUBJECT TO RETURN.

Damaged Merchandise:

ICC Regulations require that claims for damaged merchandise must be made with the carrier within fifteen (15) days of receipt of merchandise. **DO NOT ACCEPT DAMAGED SHIPMENTS UNLESS SUCH DAMAGE IS NOTED ON THE DELIVERY RECEIPT AT THE TIME OF RECEIPT.** Upon prompt notification, Stryker will file a freight claim with the appropriate carrier for damages incurred. Claim will be limited in amount to the actual replacement cost. In the event that this information is not received by Stryker within the fifteen (15) day period following the delivery of the merchandise, or the damage was not noted on the delivery receipt at the time of receipt, the customer will be responsible for payment of the original invoice in full.

Claims for any short shipment must be made within thirty (30) days of invoice.

International Warranty Clause:

This warranty reflects U.S. domestic policy. Warranty outside the U.S. may vary by country. Please contact your local Stryker Medical representative for additional information.

European Representative

Stryker EMEA RA/QA Director
Stryker France
ZAC Satolas Green Pusignan
Av. De Satolas Green
69881 MEYZIEU Cedex
France

stryker[®]

3800 E. Centre Ave., Portage, MI 49002-9799
(800) 327-0770
www.stryker.com



JH 11/05 2040-109-015 REV C