

## Performance-PRO™ XT



















Operations Manual









REF 6086





# Symbols

	Refer to instruction manual/booklet
	Consult instructions for use
	General warning
	Caution
	Warning; crushing of hands
	No pushing
	CE mark
	UK Conformity Assessment mark
	Importer
	Unique device identifier
	Authorized representative in the European Community
	Authorized representative in Switzerland
	European medical device
	Catalogue number
	Lot (batch) code
	Serial number
	For US Patents see <a href="http://www.stryker.com/patents">www.stryker.com/patents</a>
	Manufacturer

	Date of manufacture
	Mass of equipment with safe working load
	Safe working load
	Do not clean with bleach
	Shoulder restraint
	Double buckle waist restraint
	Single buckle waist restraint
	Thigh restraint
	Ankle restraint

# Table of Contents

Warning/Caution/Note Definition .....	3
Summary of safety precautions .....	3
Introduction .....	6
Product description .....	6
Indications for use .....	6
Clinical benefits .....	6
Contraindications .....	7
Expected service life .....	7
Disposal/recycle .....	7
Specifications .....	7
Standards with required options .....	8
Product illustration .....	9
Contact information .....	9
Serial number location .....	10
Date of manufacture .....	10
Setup .....	11
Installation .....	12
Installing the cot fastener .....	12
Selecting the vehicle safety hook .....	12
Vehicle configuration .....	13
Positioning of the vehicle safety hook, front to back .....	14
Positioning of the vehicle safety hook, side to side .....	15
Installing the vehicle safety hook .....	16
Operation .....	18
Setting cot load height .....	18
Operating guidelines .....	18
Proper lifting techniques .....	19
Transferring the patient to the cot .....	19
Rolling the cot with a patient .....	20
Raising or lowering the cot with two operators .....	20
Raising or lowering the cot with one operator .....	21
Loading or unloading a cot with the Power-LOAD option .....	21
Loading a cot into a vehicle with an antler style cot fastener .....	21
Unloading a cot from a vehicle with an antler style cot fastener .....	22
Positioning operators and helpers with the right hand release option .....	24
Positioning operators and helpers with the left hand release option .....	24
Raising or lowering the backrest .....	24
Raising or lowering the siderails .....	25
Raising or lowering the siderails (XPS™ option) .....	25
Extending the retractable head section .....	25
Retracting the retractable head section .....	26
Raising or lowering the footrest .....	26
Raising or lowering the knee Gatch option .....	26
Applying or releasing a wheel lock .....	27
Applying or releasing the kickstand option for dialysis scale .....	27
Securing the patient with the G-rated restraint straps .....	28
Attaching the shoulder, thigh, or ankle restraints .....	29
Attaching the waist restraints .....	30
Adjusting restraint straps .....	30
Adding a restraint strap extension .....	31
Securing a patient with the X-restraint/XPR® restraint straps .....	31
Attaching the X-restraint/XPR shoulder restraints .....	32
Attaching the X-restraint/XPR waist restraints .....	33
Attaching the X-restraint/XPR thigh restraints .....	33
Attaching the X-restraint/XPR ankle restraints .....	33

Attaching the X-restraint/XPR ankle restraints .....	34
Securing the patient with the Pedi-Mate® infant restraint system .....	34
Attaching the defibrillator platform .....	35
Hanging equipment from the equipment hook .....	38
Attaching the head extension with pillow .....	38
Positioning the two-stage IV pole .....	38
Positioning the three-stage IV pole option .....	39
Attaching an oxygen bottle to the oxygen bottle holder .....	40
Attaching an oxygen bottle to the retractable head section oxygen bottle holder .....	40
Attaching the base storage net option .....	41
Attaching the backrest storage pouch .....	41
Attaching the head end storage flat option .....	42
Attaching the mattress .....	43
Accessories and parts .....	44
Cleaning and disinfecting with SideKick® .....	45
Cleaning and disinfecting the XPR restraint straps .....	46
Cleaning .....	47
Suggested cleaners .....	47
Preventive maintenance .....	48
Regular inspection and adjustments .....	48
Every month or two hours .....	48
Every three months or six hours .....	48
Every six months or 12 hours .....	49
Every 12 months or 24 hours .....	49
Foot end fastener part replacement schedule .....	50

# Warning/Caution/Note Definition

The words **WARNING**, **CAUTION**, and **NOTE** carry special meanings and should be carefully reviewed.

## **WARNING**

Alerts the reader about a situation which, if not avoided, could result in death or serious injury. It may also describe potential serious adverse reactions and safety hazards.

## **CAUTION**

Alerts the reader of a potentially hazardous situation which, if not avoided, may result in minor or moderate injury to the user or patient or damage to the product or other property. This includes special care necessary for the safe and effective use of the device and the care necessary to avoid damage to a device that may occur as a result of use or misuse.

**Note** - Provides special information to make maintenance easier or important instructions clearer.

## Summary of safety precautions

Always read and strictly follow the warnings and cautions listed on this page. Service only by qualified personnel.

---

### **WARNING**

- Always install the cot fastener by qualified personnel only. Improper installation could result in injury to the patient or operator.
- Always make sure that all cots meet the installation specifications for the Stryker cot fastener system.
- Always adjust the rail clamp assembly to match the cot retaining post position for the cot manufacturer and model number.
- Always adjust the mounting location to maintain the proper position of the vehicle safety hook face when you replace an existing vehicle safety hook with a new style.
- Always have a certified mechanic, familiar with ambulance vehicle construction, install the vehicle safety hook to avoid injury to the patient or operator.
- Always consult the vehicle manufacturer before you install the vehicle safety hook. Make sure that the installation of the vehicle safety hook does not damage or interfere with the brake lines, oxygen lines, fuel lines, fuel tank, or electrical wiring of the vehicle.
- Do not modify the cot or the vehicle safety hook. If the cot safety bar does not connect with the vehicle safety hook in any of these positions (left, center, or right), modify the vehicle.
- Always make sure that the cot safety bar connects with the vehicle safety hook every time before you install the vehicle safety hook.
- Always make sure that the cot safety bar connects with the vehicle safety hook before you remove the cot from the vehicle patient compartment to avoid the risk of injury.
- Always use screws that are long enough to go through the vehicle patient compartment floor, washer, and nut, with at least two full threads in the nut. The socket head cap screw length depends on the thickness of the vehicle floor.
- Do not allow untrained assistants to assist in the operation of the product.
- Always follow proper hand placement on hand grips. Keep all hands clear of the red safety bar pivots when you load or unload the cot or change cot height position.
- Do not ride on the base of the cot.
- Do not transport the cot sideways to avoid the risk of tipping. Always transport the cot in a lowered position, head end or foot end first to minimize the risk of tipping.
- Always keep hands, fingers, and feet away from moving parts. Use caution when placing your hands and feet near the base tubes while you raise or lower the cot.
- Always use all restraint straps to secure the patient on the product. An unrestrained patient may fall from the product and be injured.
- Do not leave a patient unattended. Hold the product while a patient is on the product.
- Do not apply a wheel lock when a patient is on the product or when you move the product to avoid the risk of tipping.
- Do not use siderails as a patient restraint device.

- Always transport the cot at a lower height to reduce the risk of a cot tip. If possible, obtain additional assistance or take an alternate route.
- Always avoid high obstacles, such as curbing, steps, or rough terrain to avoid the risk of the product tipping over.
- Always keep hands away from the foot end release handle when you raise or lower the cot with the side release handle.
- Always remove your foot from the base tube when you lower the cot to the lowest position.
- Always use **Power-LOAD** with the 6085/6086 **Performance-PRO XT**, 6500/6506 **Power-PRO XT**, and 6510/6516 **Power-PRO IT** cots with the **Power-LOAD** option only. In certain situations, you can use **Power-LOAD** as a standard antler for most X-frame cots, but a rail clamp assembly is required for all cots without the **Power-LOAD** option.
- Always make sure that you use a **Power-PRO** date of manufacture cot with the Stryker Model 6390 **Power-LOAD** system to avoid the risk of injury.
- Always support the load of the patient, cot, and accessories after the weight is off of the ground.
- Always use two operators when a cot is occupied.
- Do not pull or lift on the cot safety bar when you unload the cot.
- Always lock the undercarriage before you remove the loading wheels from the vehicle patient compartment floor. An unlocked undercarriage will not support the cot and injury to the patient or operator could result.
- Do not allow the cot undercarriage to drop unassisted (commonly known as a hot drop) when you remove the cot from the vehicle. Repeated hot dropping causes premature wear or damage to the cot.
- Always lock the head section into place before you operate the cot.
- Do not load the cot into a vehicle with the head section retracted when using a cot fastener. The cot may tip or not connect with the cot fastener.
- Do not install or apply a wheel lock on a product with worn wheels that are less than 6 in. diameter.
- Do not leave a patient or occupant unattended. Hold the product while a patient or occupant is on the product.
- Always use two operators when using the kickstand.
- Always center the patient weight on the cot before you use the kickstand.
- Always apply the kickstand with your foot only.
- Always lower the cot height before you apply the kickstand for increased stability.
- Do not apply the kickstand during transport. Keep the kickstand in the retracted position.
- Do not use the kickstand as a brake.
- Do not apply the kickstand on a sloped surface.
- Do not attach restraint straps to the base tubes or cross tubes.
- Always form an X with the waist restraint strap and the shoulder restraint strap.
- Always locate the buckle away from obstructions or accessories on the cot to avoid the risk of accidental release of **Pedi-Mate®** infant restraint system and injury to the infant.
- Do not attach the defibrillator platform on a Model 6086 **Performance-PRO XT** cot with the **Power-LOAD** option to avoid the risk of a cot tip.
- Do not use the oxygen bottle holder to hold an oxygen bottle holder when the transport vehicle is in motion. Always place the oxygen bottle holder in an appropriate storage location when the transport vehicle is in motion.
- Always inspect the straps and clips for wear between use. Replace the strap if it no longer holds the oxygen bottle.
- Do not pinch your fingers between the Fowler bracket and the oxygen bottle if your cot is equipped with the retractable head section oxygen bottle holder option.
- Do not allow the head end storage flat (if equipped) to interfere with the operation of the retractable head section, safety bar, or vehicle safety hook.
- Always use any appropriate personal protective equipment while power washing to avoid inhaling contagion. Power washing equipment may aerate contamination.

---

## CAUTION

- Improper usage of the product can cause injury to the patient or operator. Operate the product only as described in this manual.
- Do not modify the product or any components of the product. Modifying the product can cause unpredictable operation resulting in injury to patient or operator. Modifying the product also voids its warranty.
- Always set the cot load height before you place the cot into service.
- Always clear any obstacles that may interfere and cause injury to the operator or patient before operating the product.
- Do not sit or stand on the siderails (XPS option).



- Do not use the siderails (XPS option) as a patient transfer device or surface (for example, to slide a patient from the cot to another surface).
  - Do not position patients with full weight on the siderails (XPS option).
  - Do not use the siderails (XPS option) as a push/pull device or to steer the product.
  - Do not entangle the restraint straps in the base frame when you raise or lower the cot.
  - Always secure the defibrillator platform to the product when you use the defibrillator platform.
  - Always use and adjust the straps that are provided with the defibrillator platform to secure the defibrillator.
  - Always change the attachment location or adjust the straps for your specific defibrillator size or shape.
  - Do not load the defibrillator platform above the safe working load of 30 lb (13.6 kg).
  - Do not load the equipment hook above the safe working load of 35 lb (15.8 kg).
  - Always remove all accessories or equipment from the equipment hook when in the vehicle.
  - Do not load the IV pole above the safe working load of 25 lb (11.3 kg).
  - Do not load the oxygen bottle holder above the safe working load of 15 lb (6.8 kg).
  - Do not use two oxygen bottle holders at the same time.
  - Do not load the base storage net above the safe working load of 20 lb (9 kg).
  - Always be careful when you retract the base to avoid damaging items that are stored in the base storage net.
  - Do not load the backrest storage pouch above the safe working load of 20 lb (9 kg).
  - Do not allow the storage pouch to interfere with the operation of the retractable head section.
  - Do not load the head end storage flat above the safe working load of 40 lb (18 kg).
  - Do not store items under the mattress. Items under the mattress may interfere with product operation.
  - Do not apply lubricants to the surfaces of the restraints.
  - Do not steam clean or ultrasonically clean the product.
  - Do not exceed 180 °F (82 °C) as the maximum water temperature.
  - Do not exceed 1500 psi (103.4 bar) as the maximum water pressure. If you use a hand held wand to wash the product, keep the pressure nozzle at a minimum of 24 in. (61 cm) from the product.
  - Always allow to air dry.
  - Always remove the battery before you wash the cot.
  - Do not clean, service, or perform maintenance while the product is in use.
  - Always use authorized parts to avoid the risk of product damage.
-

# Introduction

This manual assists you with the operation or maintenance of your Stryker product. Read this manual before operating or maintaining this product. Set methods and procedures to educate and train your staff on the safe operation or maintenance of this product.

---

## CAUTION

- Improper usage of the product can cause injury to the patient or operator. Operate the product only as described in this manual.
  - Do not modify the product or any components of the product. Modifying the product can cause unpredictable operation resulting in injury to patient or operator. Modifying the product also voids its warranty.
- 

## Note

- This manual is a permanent part of the product and should remain with the product even if the product is sold.
- Stryker continually seeks advancements in product design and quality. This manual contains the most current product information available at the time of printing. There may be minor discrepancies between your product and this manual. If you have any questions, contact Stryker Customer Service or Technical Support at 1-800-327-0770.

## Product description

The Stryker Model 6086 **Performance-PRO™ XT** is a manual ambulance cot that consists of a platform mounted on a wheeled X-frame designed to support and transport a maximum weight of 700 lb (318 kg) in pre-hospital and hospital environments.

The device is collapsible for use in emergency vehicles and has an adjustable load height feature to allow the device to be set to different ambulance deck heights for proper body mechanics during loading and unloading. Duplicate foot end controls on the upper and lower lift bars accommodate different operator positions or sizes and the side release handle allows a single operator to raise and lower an unoccupied cot. The device is equipped with a retractable head section for 360-degree mobility in any height position, siderails, patient restraint straps, an adjustable pneumatic backrest, and various optional accessories that assist with transport of the patient. Maximum patient comfort is attainable with the three different litter positions of shock, flat leg, and optional knee Gatch positioning.

## Indications for use

The Stryker **Performance-PRO XT** is a non-powered wheeled stretcher, which is intended to support and transport the entire body of a traumatized, ambulatory, or non-ambulatory human patient (includes infants and adults).

The device is designed to support patients in a supine (horizontal) or sitting position and facilitate the transportation of associated medical equipment (such as oxygen bottles, monitors, or pumps) in emergency or transport vehicles. This ambulance cot is intended for use in pre-hospital and hospital environments, in emergency and non-emergency applications. It is rated to a maximum capacity of 700 lb (318 kg) (sum of the patient, mattress, and accessory weight) and the intended operators of the device are trained professionals including emergency medical service and medical care center personnel, as well as medical first responders. Ambulance cots are intended for transportation purposes.

**Performance-PRO XT** is not intended for extended stay or use as a hospital bed or in devices that modify air pressure, such as hyperbaric chambers.

## Clinical benefits

Cot: patient transport

Fastener: support cot for transport

Cot and fastener system: support and transport patients

## Contraindications

None known.

## Expected service life

Performance-PRO XT cot has a seven year expected service life under normal use conditions and with appropriate periodic maintenance.

## Disposal/recycle

Always follow the current local recommendations and/or regulations governing environmental protection and the risks associated with recycling or disposing of the equipment at the end of its useful life.

## Specifications

	<b>Note</b> - Safe working load indicates the sum of the patient, mattress, and accessory weight.	700 lb	318 kg
Backrest articulation/shock position		0° to 73°/+15°	
Overall length/minimum length		80 in./64 in.	203 cm/163 cm
Height <sup>1</sup>	Position 1	13.8 in.	35.1 cm
	Position 2	22 in.	55.9 cm
	Position 3	25.8 in.	66.5 cm
	Position 4	28.1 in.	71.4 cm
	Position 5	31.9 in.	81 cm
	Position 6	34.6 in.	87.9 cm
	Position 7 (low)	37.3 in.	94.7 cm
	Position 8 (mid)	40 in.	101.6 cm
Position 9 (high)	42.2 in.	107.2 cm	
Weight <sup>2</sup>		89 lb	40.37 kg
Caster diameter/width		6 in./2 in.	15 cm/5 cm
Minimum operators required for loading/unloading an occupied cot		2	
Minimum operators required for loading/unloading an unoccupied cot		1	
Recommended fastener systems		Model 6370 or 6377 floor mount type, Model 6371 wall mount type, Model 6390 <b>Power-LOAD</b> , and Model 6392 <b>Performance-LOAD</b>	
Recommended loading height <sup>3</sup>		Up to 34 in.	Up to 86.4 cm
Dual wheel lock		Standard	

<sup>1</sup> Height measured from bottom of mattress at seat section to ground level.

<sup>2</sup> Cot is weighed with without mattress and restraints.

<sup>3</sup> Set the load wheel height between 27.25 in. (69.2 cm) and 34 in. (86.4 cm).

Stryker reserves the right to change specifications without notice.

The **Performance-PRO XT** is designed to conform to the Federal Specification for the Star-of-Life Ambulance (KKK-A-1822).

The **Performance-PRO XT** is designed to be compatible with competitive cot fastener systems.

The yellow and black color scheme is a proprietary trademark of Stryker Corporation.

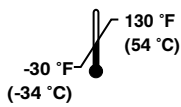
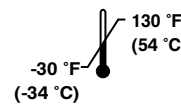
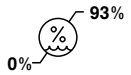
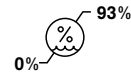
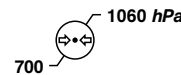
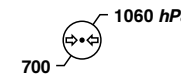
Environmental conditions	Operation	Storage and transportation
Temperature		
Relative humidity		
Atmospheric pressure		

## Standards with required options

To be compliant with the standards, you must install the following required options on your cot.

**Note** - Compatible cot is loaded into **Power-LOAD** in powered mode for crash testing.

Standard	Option selection		
	Restraint package	Mattress	Option
SAE J3027 crash-test standards with the use of a crash-rated fastener	<b>XPR</b> restraint package (650600030010) or <b>X</b> -restraint package (6500-001-430)	Knee Gatch bolster mattress (6500-002-150/6506-002-150) or <b>XPS</b> mattress (6500-003-130/6506-003-130) (depending on cot siderail)	
BS EN 1789:2007+A2:2014 crash-test standards with the use of a crash-rated fastener	<b>XPR</b> restraint package (650600030010), <b>X</b> -restraint package (6500-001-430), or <b>G</b> -rated restraint package (6500-002-030)	Knee Gatch bolster mattress (6500-002-150/6506-002-150) or <b>XPS</b> mattress (6500-003-130/6506-003-130) (depending on cot siderail)	

## Product illustration

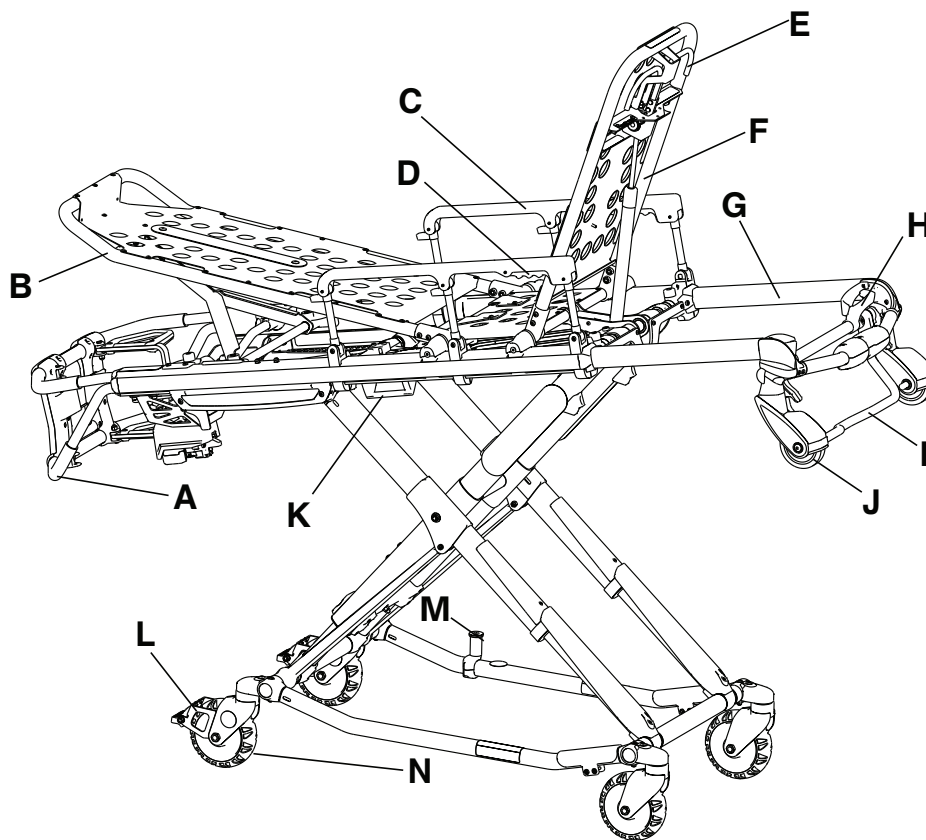

Figure 1 – Performance-PRO XT

A	Foot end release handle	H	Head section release
B	Footrest	I	Safety bar
C	Siderail	J	Loading wheel
D	Siderail release	K	Side release handle
E	Backrest adjustment handle	L	Wheel lock option
F	Backrest	M	Cot retaining post
G	Retractable head section	N	Transport wheel

## Contact information

Contact Stryker Customer Service or Technical Support at: 1-800-327-0770.

Stryker Medical  
3800 E. Centre Avenue  
Portage, MI 49002  
USA

**Note** - The user and/or the patient should report any serious product-related incident to both the manufacturer and the Competent authority of the European Member State where the user and/or patient is established.

To view your operations or maintenance manual online, see <https://techweb.stryker.com/>.

Have the serial number (A) of your Stryker product available when calling Stryker Customer Service or Technical Support. Include the serial number in all written communication.

## Serial number location

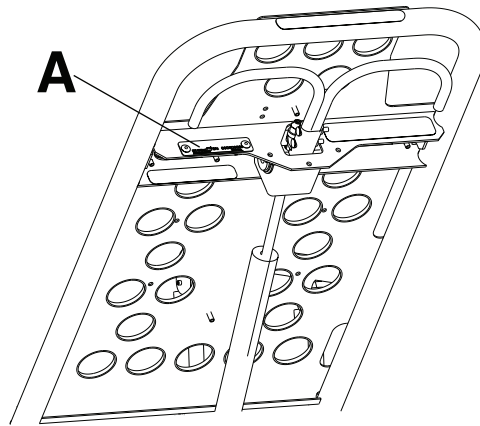

Figure 2 – Serial number location

## Date of manufacture

The year of manufacture is the first 2 digits of the serial number.

# Setup

During setup, unpack the cartons and check all items for proper operation. Make sure that the product operates before you place it into service.

Remove all shipping and packaging materials from the product before use.

The vehicle patient compartment where the product will be used must have a:

- Smooth rear edge for product loading
- Level floor large enough for the folded product
- Stryker cot fastener system
- Space to properly install the safety hook

**Note** - Loose items or debris on the patient compartment floor can interfere with the operation of the safety hook and product fastener. Keep the patient compartment floor clear.

When necessary, modify the vehicle to fit the cot. Do not modify the cot.

# Installation

## Installing the cot fastener

The Stryker cot fastener systems are compatible only with cots that conform to the installation specifications.

---

### WARNING

- Always install the cot fastener by qualified personnel only. Improper installation could result in injury to the patient or operator.
  - Always make sure that all cots meet the installation specifications for the Stryker cot fastener system.
  - Always adjust the rail clamp assembly to match the cot retaining post position for the cot manufacturer and model number.
- 

These instructions are intended for cots with antler style cot fastener systems. For crash-rated cot fasteners, see the appropriate Operations Manual for installation instructions.

## Selecting the vehicle safety hook

The vehicle safety hook is a device that ships with the cot. The cot safety bar and vehicle safety hook keep the cot from being accidentally removed from the vehicle and provide increased operator assurance and confidence when loading and unloading.

---

**WARNING** - Always adjust the mounting location to maintain the proper position of the vehicle safety hook face when you replace an existing vehicle safety hook with a new style.

---

**Note** - These instructions are intended for cots with antler style cot fastener systems. For crash-rated cot fasteners, see the appropriate Operations Manual for installation instructions. Crash-rated cot fasteners are shipped and installed with a vehicle safety hook, so no additional hook is needed.

The vehicle safety hook was designed for compatibility and proper operation when loading and unloading the cot from a vehicle that is compliant with Federal Regulation KKK-A-1822. Stryker offers three different types of vehicle safety hooks that are ordered and shipped with your cot. These vehicle safety hook types meet the needs of various emergency vehicle configurations, specifically the length and location of the floor structure support that is located in the rear of the vehicle.

To select which vehicle safety hook is appropriate for your vehicle configuration:

- Consider the location of the floor structure support where there is adequate room to mount the vehicle safety hook.
- Mount the vehicle safety hook into the back of the vehicle. Provide bumper clearance to allow the operators to load and unload the cot from the vehicle.
- Note the differences in vehicle design. Each vehicle safety hook provides a different mounting location option to maintain the appropriate distance between the face of the vehicle safety hook and the edge of the door sill.

Due to the differences in vehicle dimensions and the floor structure support locations, each vehicle safety hook allows for a different mounting location. Select the correct position for your vehicle safety hook installation.

- *Positioning of the vehicle safety hook, front to back* (page 14)
- *Positioning of the vehicle safety hook, side to side* (page 15)



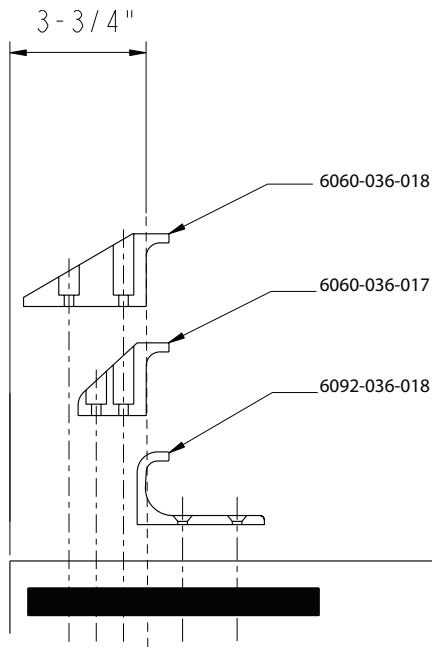

Figure 3 – Vehicle safety hook types

## Vehicle configuration

### WARNING

- Always have a certified mechanic, familiar with ambulance vehicle construction, install the vehicle safety hook to avoid injury to the patient or operator.
- Always consult the vehicle manufacturer before you install the vehicle safety hook. Make sure that the installation of the vehicle safety hook does not damage or interfere with the brake lines, oxygen lines, fuel lines, fuel tank, or electrical wiring of the vehicle.

**CAUTION** - Always set the cot load height before you place the cot into service.

The cot is compatible with all vehicle deck heights that meet the Federal Specification for the Star-of-Life Ambulance KKK-A-1822. See specifications for maximum load height.

According to Federal Specification for the Star-of-Life Ambulance KKK-A-1822:

- The rear of the ambulance shall be furnished with a sturdy, full-width, rear bumper, with a step secured to the vehicle's chassis frame.
- The tread of the step shall have a minimum depth of 5 in. (13 cm) and a maximum depth of 10 in. (25 cm).
- If the step protrudes more than 7 in. (18 cm) from the rear of the vehicle, a fold-up step shall be furnished.

According to Federal Specification for the Star-of-Life Ambulance KKK-A-1822, the bumper height of the vehicle shall be installed equidistant  $\pm 2$  in. ( $\pm 5$  cm) from the vehicle floor to the ground level, which is defined as the vehicle deck height. Installation of the vehicle safety hook into any vehicle compliant with this federal specification provides adequate clearance for the cot base to lower to its fully extended position.

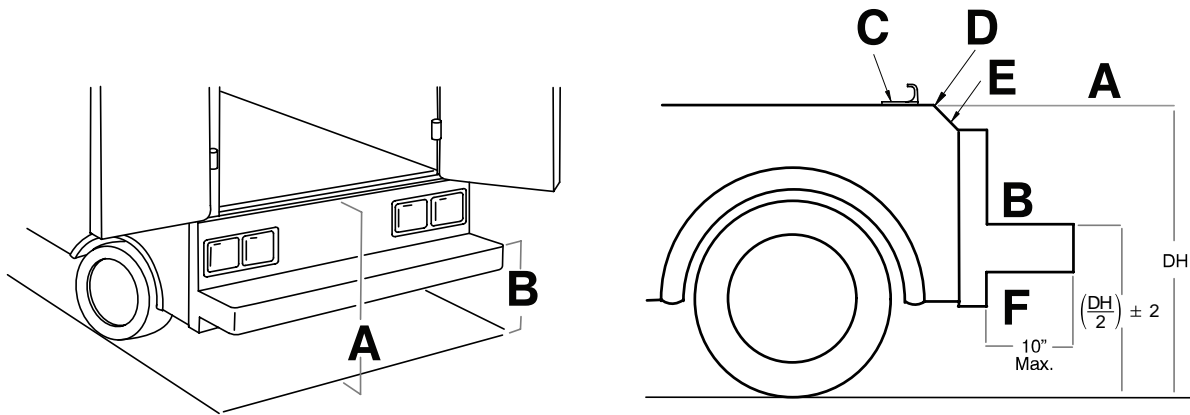

**Figure 4 – Deck and bumper height**

A	Deck height (DH)
B	Bumper height
C	Vehicle safety hook
D	Sill edge
E	Sill
F	Bumper depth

## Positioning of the vehicle safety hook, front to back

Before vehicle safety hook installation, check the front to back and side to side positioning when you unload and load the cot.

To check the front to back positioning:

1. Select the appropriate vehicle safety hook. See *Selecting the vehicle safety hook* (page 12).
2. Position the vehicle safety hook at least 3-3/4 in. from the leading edge of the door sill (A) (Figure 5). The recommended distance from the face of the safety hook is no less than 3-3/4 in.
3. Check that you can secure the vehicle safety hook to the mount in the back of the vehicle.
4. Check that you have adequate bumper clearance to allow the cot to be loaded and unloaded from the vehicle.
5. Confirm the side to side placement of the vehicle safety hook. See *Positioning of the vehicle safety hook, side to side* (page 15).

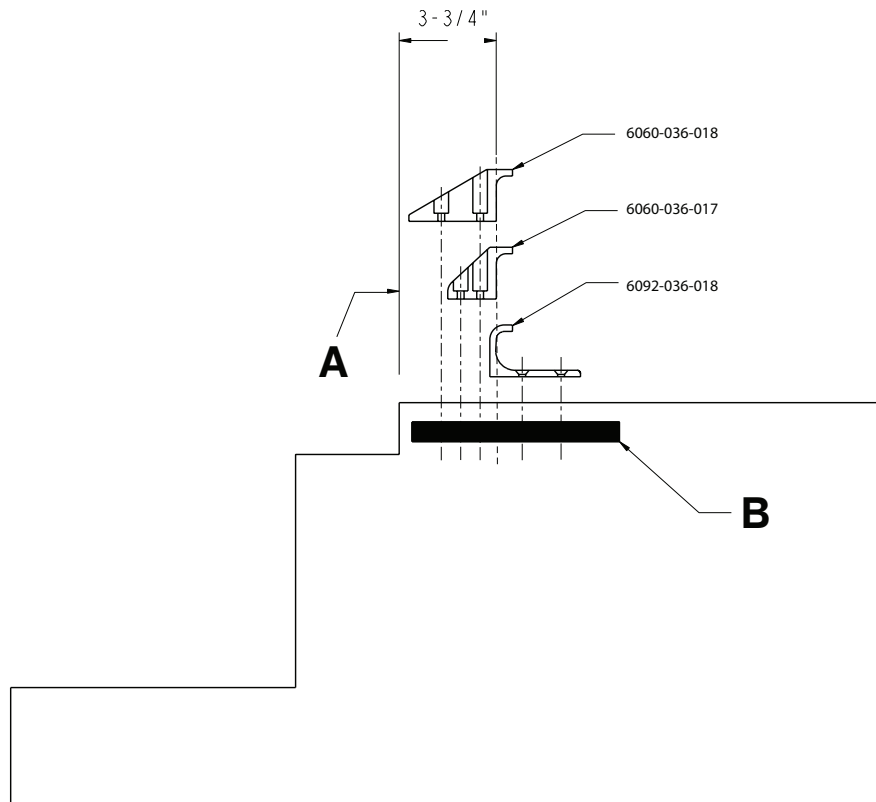

Figure 5 – Vehicle safety hook placement

A	Sill
B	Floor structure support

## Positioning of the vehicle safety hook, side to side

Before vehicle safety hook installation, check the front to back and side to side positioning when you unload and load the cot.

### WARNING

- Do not modify the cot or the vehicle safety hook. If the cot safety bar does not connect with the vehicle safety hook in any of these positions (left, center, or right), modify the vehicle.
- Always make sure that the cot safety bar connects with the vehicle safety hook every time before you install the vehicle safety hook.

To check the side to side positioning:

1. Remove the cot from the cot fastener and unload it from the vehicle.

**Note** - Pay attention to the position of the cot load wheels and the cot safety bar when you remove the cot.

2. Mark the center of the cot safety bar on the vehicle floor.
3. Check that the position marked in step 2 is where the cot safety bar connects with the vehicle safety hook every time when you unload the cot in a variety of positions (such as all the way to the left and all the way to the right).

## Installing the vehicle safety hook

Before vehicle safety hook installation, the certified mechanic should plan for the placement of the vehicle safety hook in the rear of the vehicle patient compartment.

---

### WARNING

- Always have a certified mechanic, familiar with ambulance vehicle construction, install the vehicle safety hook to avoid injury to the patient or operator.
  - Always consult the vehicle manufacturer before you install the vehicle safety hook. Make sure that the installation of the vehicle safety hook does not damage or interfere with the brake lines, oxygen lines, fuel lines, fuel tank, or electrical wiring of the vehicle.
  - Always make sure that the cot safety bar connects with the vehicle safety hook before you remove the cot from the vehicle patient compartment to avoid the risk of injury.
  - Always use screws that are long enough to go through the vehicle patient compartment floor, washer, and nut, with at least two full threads in the nut. The socket head cap screw length depends on the thickness of the vehicle floor.
- 

### Hardware required (not supplied):

- (2) Grade 5, minimum 1/4"-20 socket head cap screws \* for the short vehicle safety hook or long vehicle safety hook
  - (2) Grade 5, minimum 1/4"-20 flat socket head cap screws \* for the J vehicle safety hook
  - (2) Flat washers
  - (2) Lock washers
  - (2) 1/4"-20 nuts
1. Determine the correct vehicle safety hook front to back and side to side positioning, so the cot safety bar connects to the vehicle safety hook every time.
    - *Positioning of the vehicle safety hook, front to back* (page 14)
    - *Positioning of the vehicle safety hook, side to side* (page 15)
  2. Drill the holes for the screws.
  3. Fasten the vehicle safety hook to the vehicle patient compartment floor.
  4. Check that the cot safety bar connects with the vehicle safety hook before you remove the cot from the vehicle patient compartment.

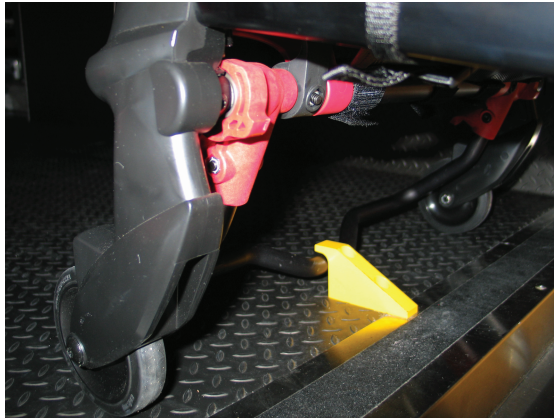

**Figure 6 – Safety bar secured in the vehicle safety hook**

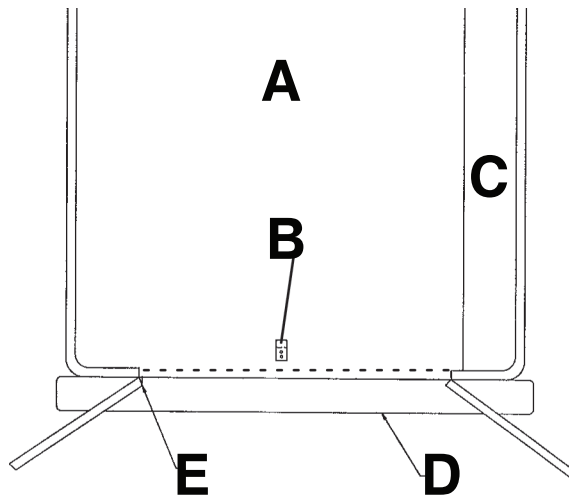

**Figure 7 – Vehicle safety hook placement**

A	Top view of vehicle
B	Vehicle safety hook
C	Squad bench
D	Bumper
E	Door frame

After installation, check that the cot legs lock into the load position without contacting the vehicle bumper.

# Operation

## Setting cot load height

---

**CAUTION** - Always set the cot load height before you place the cot into service.

---

Adjust the cot load height to match the vehicle deck. If the cot does not line up correctly, you may also adjust the cot load height.

To set the cot load height:

1. Roll the cot to the loading area of your vehicle.
2. Compare the difference between the deck height of the vehicle and the load height of the cot.
3. Select high, mid, or low depending on the cot load height requirements.

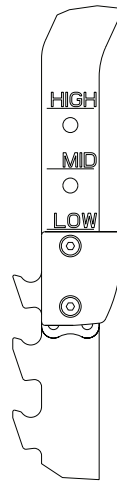

**Figure 8 – Set desired cot load height**

Cot load height	For deck heights
High	Above 32 in.
Mid	Between 30-32 in.
Low	Below 30 in.

4. Make sure that the cot safety bar connects with the vehicle safety hook every time when you unload the cot in a variety of positions. If the cot safety bar misses the vehicle safety hook, select the next lower height setting.

## Operating guidelines

---

### WARNING

- Do not allow untrained assistants to assist in the operation of the product.
  - Always follow proper hand placement on hand grips. Keep all hands clear of the red safety bar pivots when you load or unload the cot or change cot height position.
  - Do not ride on the base of the cot.
  - Do not transport the cot sideways to avoid the risk of tipping. Always transport the cot in a lowered position, head end or foot end first to minimize the risk of tipping.
  - Always keep hands, fingers, and feet away from moving parts. Use caution when placing your hands and feet near the base tubes while you raise or lower the cot.
-

---

**CAUTION** - Always clear any obstacles that may interfere and cause injury to the operator or patient before operating the product.

---

- Operate the product only as described in this manual.
- Read all labels and instructions on the product before use.
- Practice changing height positions and loading the cot until you fully understand the operation of the product.
- Always load or unload an occupied cot with a minimum of two trained operators. Two operators must be present when a cot is occupied. Stryker recommends that both operators are at the foot end to reduce the load on each operator. One or two operators can lift from the foot end of the cot.
- Do not adjust, roll, or load the cot into a vehicle without advising the patient. Stay with the patient and control the product at all times.
- You can transport the cot in any position. Stryker recommends that the operators transport the patient in the lowest comfortable position to maneuver the cot.
- Only use the wheel locks during patient transfer or without a patient on the product.
- Do not apply a wheel lock when an occupant is on the product or when moving the product to avoid the risk of tipping.
- Always use all restraint straps to secure the patient on the product. An unrestrained patient may fall from the product.
- Use properly trained helpers to control the cot, when necessary.

## Proper lifting techniques

When you lift the product and patient, follow these proper lifting techniques to avoid the risk of injury:

- Keep your hands close to your body
- Keep your back straight
- Coordinate all movement with your partner
- Lift with your legs
- Avoid twisting

## Transferring the patient to the cot

---

### WARNING

- Always use all restraint straps to secure the patient on the product. An unrestrained patient may fall from the product and be injured.
  - Do not leave a patient unattended. Hold the product while a patient is on the product.
  - Do not apply a wheel lock when a patient is on the product or when you move the product to avoid the risk of tipping.
  - Do not use siderails as a patient restraint device.
- 

To transfer the patient to the product:

1. Roll the product to the patient (*Rolling the cot with a patient (page 20)*).
2. Place the product beside the patient and raise or lower the product to the level of the patient.
3. Lower the siderails and open the restraint straps.
4. Transfer the patient to the product. Follow accepted EMS procedures.
5. Secure the patient to the product with all of the restraint straps.
6. Raise the siderails and adjust the backrest and footrest as necessary.

## Rolling the cot with a patient

### WARNING

- Always transport the cot at a lower height to reduce the risk of a cot tip. If possible, obtain additional assistance or take an alternate route.
- Always avoid high obstacles, such as curbing, steps, or rough terrain to avoid the risk of the product tipping over.

To roll the cot with a patient:

1. Position one operator at the foot end and one operator at the head end of the cot.
2. Lift each set of wheels over the door sill or obstacle separately.

## Raising or lowering the cot with two operators

Always raise or lower an occupied cot with a minimum of two trained operators. Two operators must be present when a cot is occupied. Operators must be able to lift the total weight of the patient, cot, and any items on the cot.

### WARNING

- Always keep hands, fingers, and feet away from moving parts. Use caution when placing your hands and feet near the base tubes while you raise or lower the cot.
- Always follow proper hand placement on hand grips. Keep all hands clear of the red safety bar pivots when you load or unload the cot or change cot height position.
- Always keep hands away from the foot end release handle when you raise or lower the cot with the side release handle.

To raise or lower the cot:

From the head end and foot end	From the left side and right side
<ol style="list-style-type: none"><li>1. Operator 1 (at the foot end): Squeeze the release handle with a secure grip on the lifting bars.</li><li>2. Both operators:<ol style="list-style-type: none"><li>2.1. Lift the foot end of the cot until you lift the weight off of the latching mechanism.</li><li>2.2. Operator 1 (at the foot end): Squeeze and hold the release handle while both operators raise or lower the cot together.</li><li>2.3. Operator 1 (at the foot end): Release the release handle when you reach the desired height.</li><li>2.4. Maintain a secure grip on the litter frame until the latching mechanism locks into place.</li></ol></li></ol>	<ol style="list-style-type: none"><li>1. Check the cot to determine if the side release handle is on the patient left or patient right side.</li><li>2. Operator 1 (on the side with the release handle): Reach the release handle at the midpoint of the litter.</li><li>3. Both operators:<ol style="list-style-type: none"><li>3.1. Lift the foot end of the cot until you lift the weight off of the latching mechanism (approximately 1/4").</li><li>3.2. Operator 1 (on the side with the release handle): Squeeze and hold the release handle.</li><li>3.3. Raise or lower the cot.</li><li>3.4. Operator 1 (on the side with the release handle): Release the release handle when you reach the desired height.</li><li>3.5. Maintain a secure grip on the litter frame until the latching mechanism locks into place.</li></ol></li></ol>



## Raising or lowering the cot with one operator

You can raise or lower an unoccupied cot into a vehicle with one operator.

### WARNING

- Always keep hands, fingers, and feet away from moving parts. Use caution when placing your hands and feet near the base tubes while you raise or lower the cot.
- Always follow proper hand placement on hand grips. Keep all hands clear of the red safety bar pivots when you load or unload the cot or change cot height position.
- Always remove your foot from the base tube when you lower the cot to the lowest position.
- Always keep hands away from the foot end release handle when you raise or lower the cot with the side release handle.

To raise or lower the cot:

From the foot end	From the side
<ol style="list-style-type: none"><li>1. Grasp the lower foot end lift tube.</li><li>2. Tip the cot up on its load wheels.</li><li>3. Squeeze and hold the release handle and raise or lower the cot.</li><li>4. Release the release handle when you reach the desired height.</li><li>5. Lower the cot back on onto the four base wheels.</li></ol>	<ol style="list-style-type: none"><li>1. Place one foot on the outer base tube.</li><li>2. Grasp the side release handle with one hand. Place your other hand on the outer support rail to stabilize the cot.</li><li>3. Squeeze and hold the release handle and raise or lower the cot.</li><li>4. Release the release handle when you reach the desired height.</li></ol>

## Loading or unloading a cot with the Power-LOAD option

The cot is fully compatible with the Model 6390 **Power-LOAD** system if you ordered the cot with the **Power-LOAD** option or upgraded your cot with the compatibility kit.

### WARNING

- Always use **Power-LOAD** with the 6085/6086 **Performance-PRO XT**, 6500/6506 **Power-PRO XT**, and 6510/6516 **Power-PRO IT** cots with the **Power-LOAD** option only. In certain situations, you can use **Power-LOAD** as a standard antler for most X-frame cots, but a rail clamp assembly is required for all cots without the **Power-LOAD** option.
- Always make sure that you use a **Power-PRO** date of manufacture cot with the Stryker Model 6390 **Power-LOAD** system to avoid the risk of injury.

Cot	Compatibility kit
Model 6506 <b>Power-PRO XT</b>	6506-700-001
Model 6516 <b>Power-PRO IT</b>	6516-700-001
Model 6086 <b>Performance-PRO XT</b>	6086-700-001

For more information about using your **Power-LOAD** compatible cot, see the **Power-LOAD** Operations Manual.

## Loading a cot into a vehicle with an antler style cot fastener

Always load an occupied cot with a minimum of two trained operators. Two operators must be present when a cot is occupied. Operators must be able to lift the total weight of the patient, cot, and any items on the cot.

### WARNING

- Always support the load of the patient, cot, and accessories after the weight is off of the ground.

- Always use two operators when a cot is occupied.
- Always follow proper hand placement on hand grips. Keep all hands clear of the red safety bar pivots when you load or unload the cot or change cot height position.

The higher an operator must lift the cot, the more difficult it may be to hold the weight. The operator must be able to lift the cot high enough for the cot legs to extend when the cot is unloaded. An operator may need help if they are too short or if the patient is too heavy to lift when unloading the cot. If you are a shorter operator, you may need to raise your arms higher to allow the cot legs to extend.

**Note** - You can load an unoccupied cot into a vehicle with one operator.

To load the cot into a vehicle:

1. Place the cot in a loading position. A loading position is any position where the load wheels meet the vehicle floor height.
2. Lift the vehicle bumper, if equipped, to the raised position.
3. Roll the cot to the open door of the vehicle patient compartment.
4. Push the cot forward until the load wheels are on the vehicle patient compartment floor and the cot safety bar passes the vehicle safety hook.
5. Pull the cot back until the cot safety bar connects to the vehicle safety hook for maximum clearance to lift the base.
6. Make sure that the cot safety bar connects with the vehicle safety hook.
7. Load the cot.

With one operator at the foot end and one operator on the side	With one operator (when loading an unoccupied cot)
<ol style="list-style-type: none"> <li>a. Operator 1 (at the foot end):               <ol style="list-style-type: none"> <li>i. Grasp the cot frame at the foot end.</li> <li>ii. Lift the foot end of the cot until you lift the weight off of the latching mechanism. Squeeze and hold the release handle.</li> </ol> </li> <li>b. Operator 2 (on the side):               <ol style="list-style-type: none"> <li>i. Grasp the cot outer rail to stabilize the cot.</li> <li>ii. Grasp the base frame.</li> <li>iii. After the foot end operator lifts the cot and squeezes the release handle, raise the undercarriage until it stops in the uppermost position and hold it there.</li> <li>iv. The foot end operator should release the handle to lock the base in the retracted position.</li> </ol> </li> </ol>	<ol style="list-style-type: none"> <li>a. Grasp the cot frame at the foot end and squeeze and hold the release handle.</li> <li>b. Lower the foot end of the cot to the ground.</li> <li>c. Lift the foot end of the cot until it is level with the compartment floor.</li> <li>d. Grasp the base of the cot with one hand and pull up the base of the cot towards the litter, reducing the space between the base and the litter.</li> </ol>

8. Push the cot into the vehicle patient compartment.
9. Make sure that the cot is secured in the cot fastener (not included).

## Unloading a cot from a vehicle with an antler style cot fastener

Always unload an occupied cot with a minimum of two trained operators. Two operators must be present when a cot is occupied. Operators must be able to lift the total weight of the patient, cot, and any items on the cot.

### WARNING

- Always support the load of the patient, cot, and accessories after the weight is off of the ground.
- Always use two operators when a cot is occupied.

- Always follow proper hand placement on hand grips. Keep all hands clear of the red safety bar pivots when you load or unload the cot or change cot height position.
- Always make sure that the cot safety bar connects with the vehicle safety hook before you remove the cot from the vehicle patient compartment to avoid the risk of injury.
- Do not pull or lift on the cot safety bar when you unload the cot.
- Always lock the undercarriage before you remove the loading wheels from the vehicle patient compartment floor. An unlocked undercarriage will not support the cot and injury to the patient or operator could result.
- Do not allow the cot undercarriage to drop unassisted (commonly known as a hot drop) when you remove the cot from the vehicle. Repeated hot dropping causes premature wear or damage to the cot.

**Note** - You can unload an unoccupied cot from a vehicle with one operator.

To unload the cot from a vehicle:

1. Lift the vehicle bumper, if equipped, to the raised position.
2. Remove the cot from the cot fastener.
3. Unload the cot.

With one operator at the foot end and one operator on the side	With one operator (when unloading an unoccupied cot)
<ol style="list-style-type: none"> <li>Operator 1: Grasp the cot frame at the foot end. Pull the cot out of the vehicle patient compartment until the safety bar connects with the vehicle safety hook.</li> <li>Operator 2: Make sure that the safety bar connects with the vehicle safety hook. Grasp the base frame, lift slightly, and lower the base frame to its fully extended position while operator 1 squeezes and holds the release handle.</li> <li>Operator 1: Let go of the release handle and make sure that the undercarriage locks into place. Set the cot onto the ground.</li> <li>Operator 2: Push the cot safety bar release lever forward to remove the cot safety bar from the vehicle safety hook.</li> </ol>	<ol style="list-style-type: none"> <li>Grasp the cot frame at the foot end.</li> <li>Pull the cot out of the vehicle patient compartment until the safety bar connects with the vehicle safety hook.</li> <li>Lower the foot end of the cot to the ground.</li> <li>Squeeze and hold the release handle and raise the foot end of the cot back to a level position with the vehicle patient compartment floor.</li> <li>Push the cot safety bar release lever forward to remove the cot safety bar from the vehicle safety hook.</li> </ol>

4. Remove the load wheels from the vehicle patient compartment floor.
5. Place the cot in any position, except full down for rolling.

## Positioning operators and helpers with the right hand release option

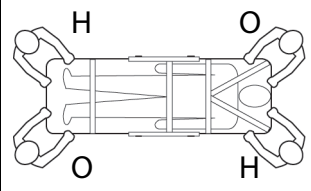
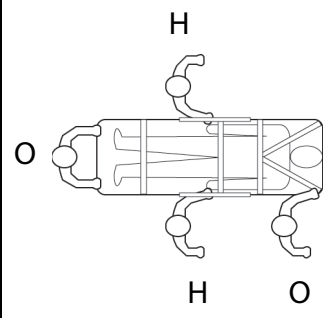
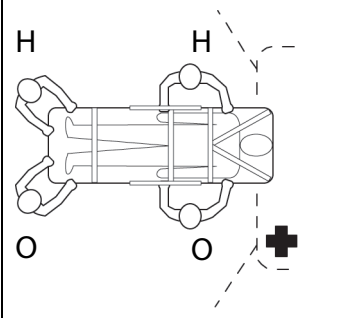
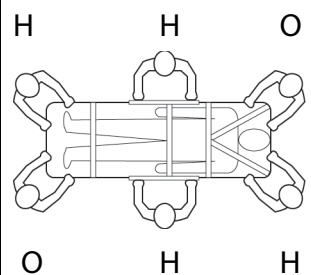
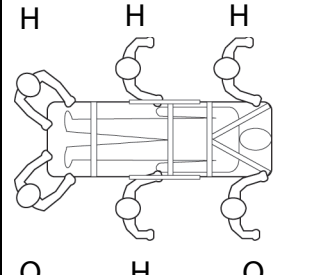
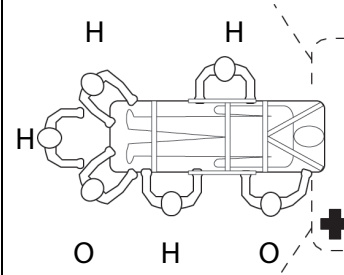
	Changing levels	Rolling	Loading and unloading
Two operators (O) Two helpers (H)			
Two operators (O) Four helpers (H)			

## Positioning operators and helpers with the left hand release option

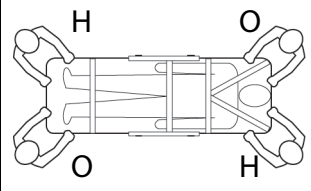
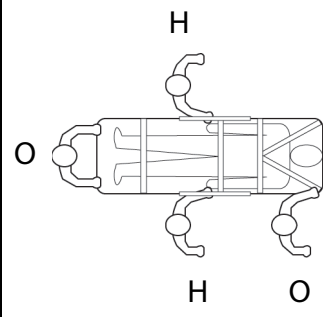
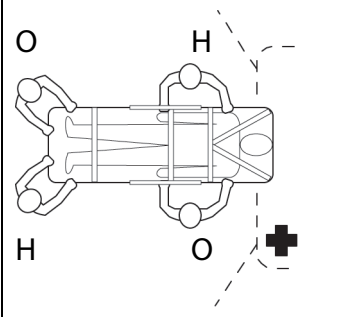
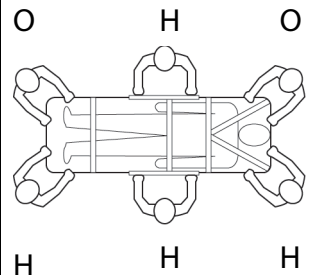
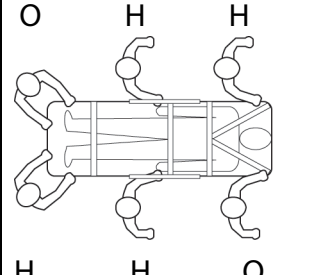
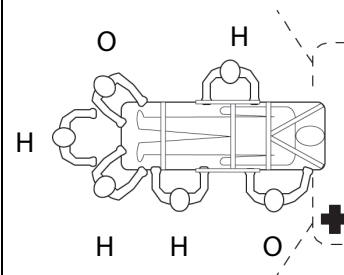
	Changing levels	Rolling	Loading and unloading
Two operators (O) Two helpers (H)			
Two operators (O) Four helpers (H)			

## Raising or lowering the backrest

To raise the backrest, squeeze the backrest adjustment handle to move the backrest to the desired height.

To lower the backrest, squeeze the backrest adjustment handle while you push down on the backrest to the desired height.

## Raising or lowering the siderails

Always lower the siderails when you transfer a patient to the cot or from the cot.

---

**WARNING** - Do not use siderails as a patient restraint device.

---

To raise the siderails, lift up on the siderail until the latch clicks and the siderail locks into place. Always keep the siderails in the raised position unless you are transferring the patient.

To lower the siderails, squeeze the siderail release handle to release the siderail latch. Guide the siderail down toward the foot end of the cot until the siderail lays flat. Always lower the siderails when you transfer a patient to or from the cot.

## Raising or lowering the siderails (XPS™ option)

You can order your cot with the expandable patient surface (XPS) option or upgrade your cot to add the XPS option.

---

**WARNING** - Do not use siderails as a patient restraint device.

---

### CAUTION

- Do not sit or stand on the siderails (XPS option).
  - Do not use the siderails (XPS option) as a patient transfer device or surface (for example, to slide a patient from the cot to another surface).
  - Do not position patients with full weight on the siderails (XPS option).
  - Do not use the siderails (XPS option) as a push/pull device or to steer the product.
- 

Siderails (XPS option) attach to the cot and are always available for your use. The siderails (XPS option) adjust according to patient size and lock into seven positions. The siderails also adjust to fit through standard doorways or elevators.

To raise the siderails, lift up on the siderail until it locks into the desired position.

To lower the siderails, lift up to relieve the weight, then pull the red lever. Always lower the siderails when you transfer a patient to or from the cot.

The XPS option is not a primary patient support surface. It includes a wider mattress and is intended to enhance patient comfort.

## Extending the retractable head section

Extend the retractable head section before you load the cot into the vehicle patient compartment.

---

### WARNING

- Always lock the head section into place before you operate the cot.
  - Do not load the cot into a vehicle with the head section retracted when using a cot fastener. The cot may tip or not connect with the cot fastener.
- 

To extend the retractable head section:

1. Grasp the outer rail with one hand for support and pull the head section release handle. Rotate the head section release handle toward the head end of the cot to release the head section from the locked position.
2. Release the head section release handle, then pull the head section away from the litter frame. Lengthen the head section to the extended position.
3. Release the head section release handle to lock the head section in the extended position.

## Retracting the retractable head section

Retract the retractable head section to roll the cot in any direction on the load wheels for improved mobility and maneuverability, even in the lowest position.

---

### WARNING

- Always lock the head section into place before you operate the cot.
  - Do not load the cot into a vehicle with the head section retracted when using a cot fastener. The cot may tip or not connect with the cot fastener.
- 

To retract the retractable head section:

1. Grasp the outer rail with one hand for support and release the head section release handle. Rotate the head section release handle toward the head end of the cot to release the head section from the locked position.
2. Release the head section release handle, then push the head section toward the litter frame. Retract the head section to the retracted position.
3. Release the head section release handle to lock the head section in the retracted position.

## Raising or lowering the footrest

You can adjust the footrest to elevate the patient's legs.

To raise the footrest, lift the frame as high as possible. The support bracket automatically secures the frame when you release the footrest.

To lower the footrest, lift the frame and lift up on the footrest release handle until the frame releases the support bracket. Lower the footrest until it lays flat.

## Raising or lowering the knee Gatch option

To raise the knee Gatch:

1. Lift either of the red lifting loops (A) until the knee Gatch is in the highest position (Figure 9).
2. Lower the knee Gatch to secure the support bracket to the locking mechanism.
3. Make sure that the locking mechanism is secure before you release the lifting loop.

To lower the knee Gatch, lift either of the red lifting loops (A) to relieve pressure on the locking mechanism, and while holding the loop, push on the red footrest release handle (B) until the support bracket is released (Figure 9). Lower the knee Gatch until it lays flat.

To raise the knee Gatch in Trendelenburg, lift the footrest frame (C) as high as possible until the frame locks into place (Figure 9). The support bracket automatically connects when you release the frame.

To lower the knee Gatch in Trendelenburg, lift the footrest frame (C) and, while holding the frame, lift up on the red footrest release handle (B) until the frame releases the support bracket (Figure 9). Lower the footrest until it lays flat.

**Note** - The foot end oxygen bottle holder option (6500-240-000) is not compatible with the knee Gatch option (6500-082-000).

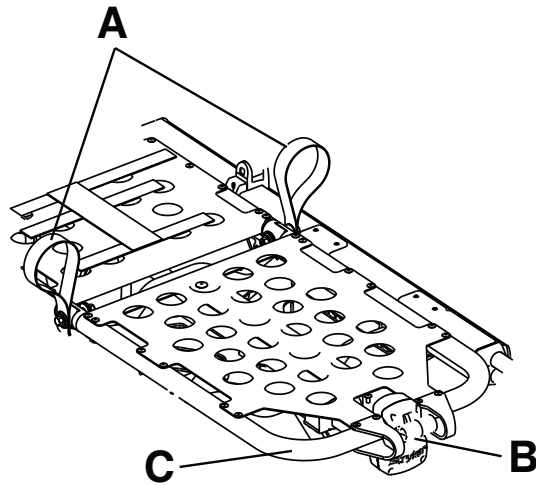

Figure 9 – Gatch

## Applying or releasing a wheel lock

---

### WARNING

- Do not apply a wheel lock when a patient is on the product or when you move the product to avoid the risk of tipping.
  - Do not install or apply a wheel lock on a product with worn wheels that are less than 6 in. diameter.
  - Do not leave a patient or occupant unattended. Hold the product while a patient or occupant is on the product.
- 

To apply a wheel lock, press down on the pedal until it stops and is resting against the surface of the wheel.

To release a wheel lock, press down on the top of the pedal with your foot or lift up on the pedal with your toe. The top of the pedal will rest against the caster frame when you release the wheel lock.

**Note** - Wheel locks help prevent the product from rolling while unattended. Wheel locks may not provide sufficient resistance on all surfaces or under loads.

## Applying or releasing the kickstand option for dialysis scale

Use the kickstand to weigh patients on a scale.

---

### WARNING

- Always use two operators when using the kickstand.
  - Always center the patient weight on the cot before you use the kickstand.
  - Always apply the kickstand with your foot only.
  - Always lower the cot height before you apply the kickstand for increased stability.
  - Do not apply the kickstand during transport. Keep the kickstand in the retracted position.
  - Do not use the kickstand as a brake.
  - Do not apply the kickstand on a sloped surface.
- 

**Note** - The kickstand option (6085-102-000) is not compatible with the base storage net option (6500-160-000).

To apply the kickstand:

1. Operator 1: Apply the kickstand with your foot.
2. Operator 2: Lift the foot end of the cot to actuate the kickstand.
3. Both operators: Make sure that the kickstand is in the forward locked position.

To release the kickstand, Operator 1 lifts the foot end of the cot until both wheels are off the floor. Operator 2 rolls the cot forward to make sure that the kickstand retracts.

## Securing the patient with the G-rated restraint straps

---

### **WARNING**

- Always use all restraint straps to secure the patient on the product. An unrestrained patient may fall from the product and be injured.
  - Do not attach restraint straps to the base tubes or cross tubes.
- 

**CAUTION** - Do not entangle the restraint straps in the base frame when you raise or lower the cot.

---

**Note** - Restraint straps are a Type BF applied part.

Secure restraint straps to the cot in the required attachment locations (Figure 10). Restraint strap attachment locations should provide strong anchorage and proper restraint position. Do not allow restraint straps to interfere with equipment or accessories. Buckle the restraint straps across the patient's shoulders, waist, and legs. Buckle restraint straps when the cot is not in use.



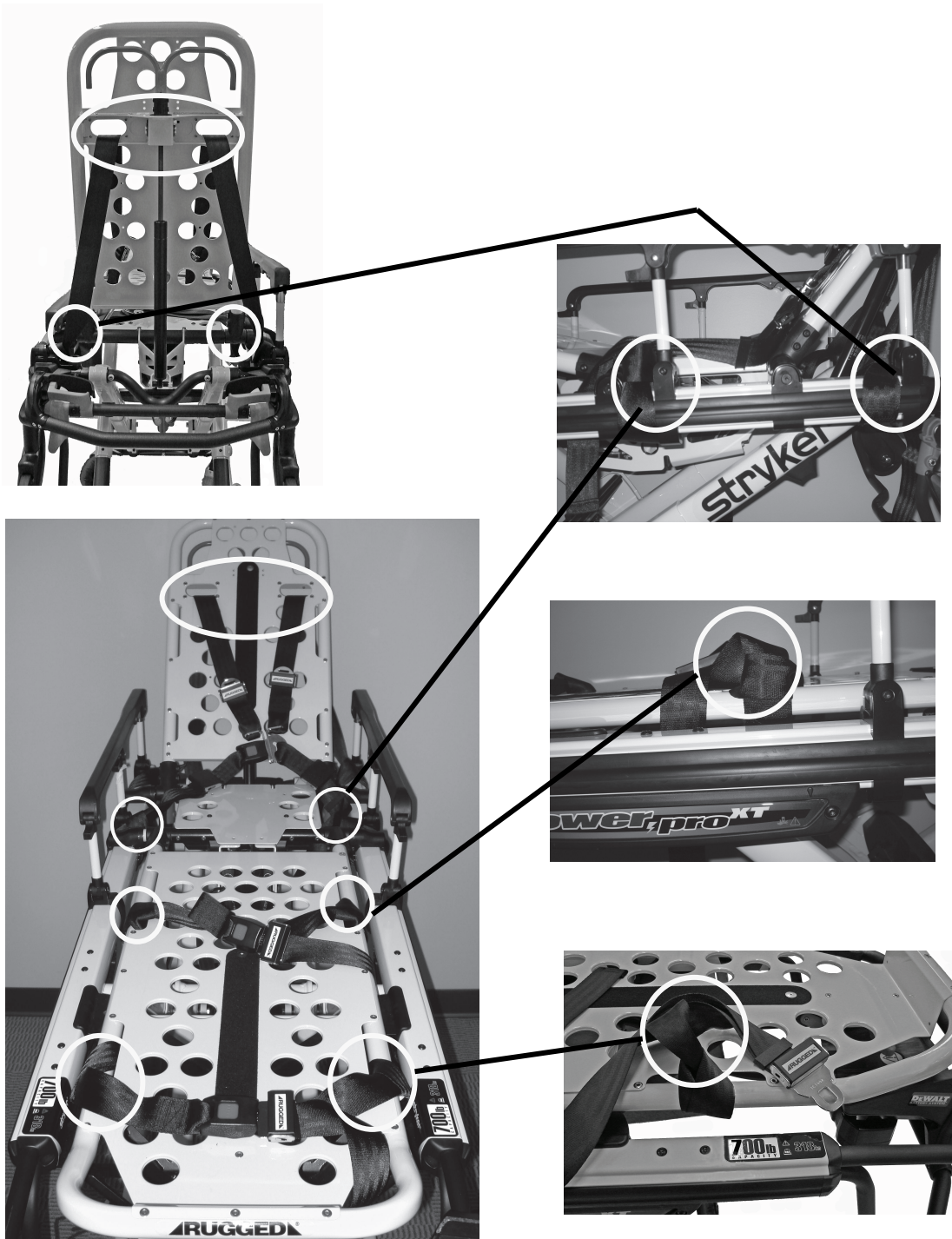

Figure 10 – Restraint strap attachment points

### Attaching the shoulder, thigh, or ankle restraints

To attach the shoulder, thigh, or ankle restraints:

1. Wrap the restraint strap around the cot frame.
2. Push the restraint strap buckle through the loop.
3. Pull the buckle around the loop to secure the restraint strap to the cot.



**Figure 11 – Wrap the restraint strap around the cot frame**



**Figure 12 – Push the restraint strap buckle through the loop**



**Figure 13 – Secure the restraint strap to the cot**

## Attaching the waist restraints

---

**WARNING** - Always form an X with the waist restraint strap and the shoulder restraint strap.

---

To attach the waist restraints:

1. Wrap the restraint strap around the cot frame.
2. Push both buckles through the loop for the double buckle strap.
3. Push the buckle and the tongue through the loop for the tongue and buckle strap.
4. Pull the buckle through the loop to secure the restraint strap to the cot.

## Adjusting restraint straps

Open the restraint straps and place them at either side of the cot while you position the patient on the cot mattress. Lengthen the restraint straps, buckle them around the patient, and shorten them to tighten.

- To open the restraint strap, press the red button on the front of the buckle receiver. This allows you to release the buckle latch plate and pull it out of the receiver.
- To close the restraint strap, push the latch plate into the receiver until you hear a click.
- To lengthen the restraint strap, grasp the buckle latch plate, turn it at an angle to the webbing, then pull it out. A hemmed tab at the end of the webbing prevents the latch plate from coming off of the strap.
- To shorten the restraint strap, grasp the hemmed tab and pull the webbing back through the latch plate to tighten.

When you buckle a restraint strap around a patient, secure the latch plate and remove any loose webbing from the cot.

Inspect the restraint straps at least once a month (more if used often). Check for a bent or broken receiver or latch plate, or torn or frayed webbing. Replace any worn or inoperable restraint strap.

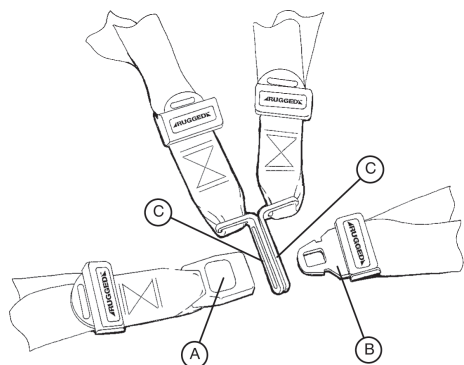

**Figure 14 – Buckle the straps around the patient**

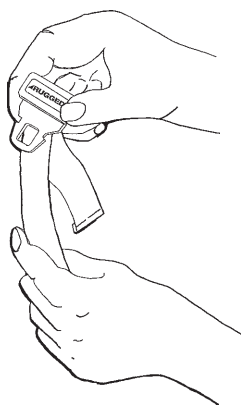

**Figure 15 – Lengthen the restraint strap**

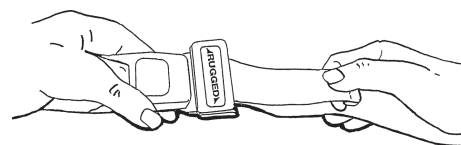

**Figure 16 – Shorten the restraint strap**

## Adding a restraint strap extension

Add a restraint strap extension (6082-160-050) for extra length when you buckle the lap belt around larger patients.

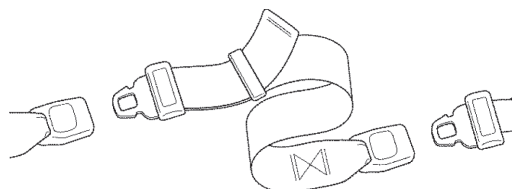

**Figure 17 – Restraint strap extension**

## Securing a patient with the X-restraint/XPR® restraint straps

Secure restraint straps to the cot in the required attachment locations: shoulders, waist, thighs, and ankles.

---

### WARNING

- Always use all restraint straps to secure the patient on the product. An unrestrained patient may fall from the product and be injured.
  - Do not attach restraint straps to the base tubes or cross tubes.
- 

**CAUTION** - Do not entangle the restraint straps in the base frame when you raise or lower the cot.

---

### Note

- The X-restraint/XPR (6500-001-430/650600030010) restraint straps are only compatible with the wider Gatch bolster mattress (6500-003-130/6506-003-130).
- Restraint straps are a Type BF applied part.

Restraint strap attachment locations should provide strong anchorage and proper restraint position (Figure 18). Do not allow restraint straps to interfere with equipment or accessories. Buckle the restraints across the shoulders, waist, thighs, and ankles. Buckle all restraint straps when the cot is not in use.

1. *Attaching the X-restraint/XPR shoulder restraints* (page 32)
2. *Attaching the X-restraint/XPR waist restraints* (page 33)
3. *Attaching the X-restraint/XPR thigh restraints* (page 33)
4. *Attaching the X-restraint/XPR ankle restraints* (page 33)



Figure 18 – Restraint strap attachment locations

### Attaching the X-restraint/XPR shoulder restraints

To attach the X-restraint/XPR shoulder restraints (Figure 19):

1. Wrap the restraint around the cot frame.
2. Pull the restraint buckle through the loop, toward the head end of the cot.
3. Feed the buckle under the XPS System.
4. For the Model 6506 Power-PRO XT cot and Model 6086 Performance-PRO XT cot, pull the restraint tight and toward the back of the backrest.
5. For the Model 6550 Power-PRO TL cot, pull the restraint under the cross tube and toward the back of the backrest.
6. Feed the buckle through the opening in the backrest.
7. Connect the patient right shoulder buckle to the patient left waist buckle.
8. Remove any slack from the restraint strap loop.



Figure 19 – Shoulder restraints

### Attaching the X-restraint/XPR waist restraints

To attach the X-restraint/XPR waist restraints (Figure 20):

1. Wrap the restraint around the cot frame.
2. Pull the restraint buckles through the loop, toward the head end of the cot.
3. Feed the buckle under the XPS System.
4. Pull the buckles tight. One restraint should angle toward the head end and one should lay straight across the cot.
5. Connect the patient right buckle to the patient left buckle.
6. Remove any slack from the restraint strap loop.



Figure 20 – Waist restraints

### Attaching the X-restraint/XPR thigh restraints

To attach the X-restraint/XPR thigh restraints (Figure 21):

1. Wrap the restraint around the cot litter.
2. Pull the restraint buckle through the loop, toward the head end of the cot.
3. Pull the restraint tight.
4. Connect the patient right buckle to the patient left buckle.
5. Remove any slack from the restraint strap loop.

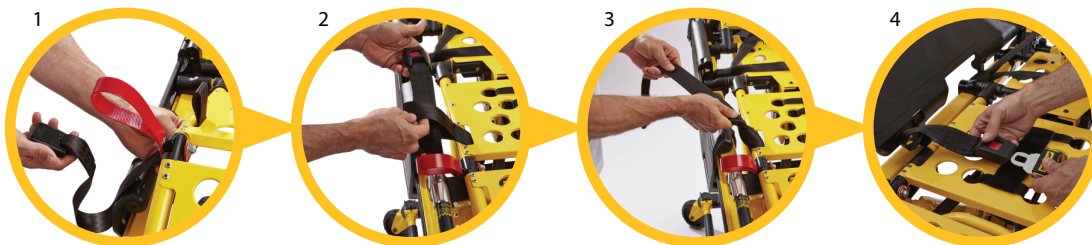

Figure 21 – Thigh restraints

### Attaching the X-restraint/XPR ankle restraints

For Model 6506 Power-PRO XT cots and Model 6086 Performance-PRO XT cots built before July 3, 2015 with the Gatch option only.

To attach the X-restraint/XPR ankle restraints (Figure 22):

1. Wrap the restraint around the cot frame. Wrap around both foot end lift bars.
2. Pull the restraint buckle through the loop, toward the head end of the cot.
3. Pull the buckle tight.
4. Connect the patient right buckle to the patient left buckle.
5. Remove any slack from the restraint strap loop.

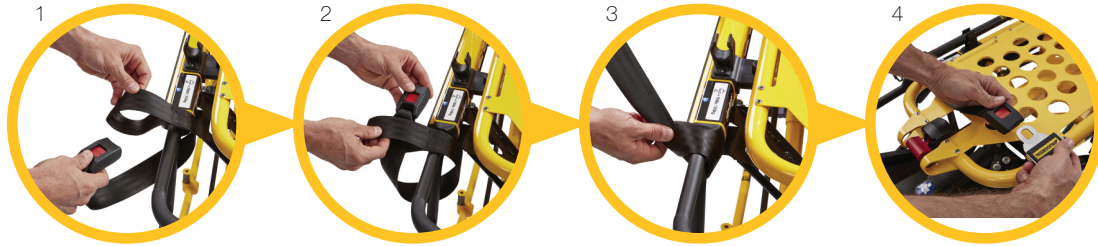

Figure 22 – Ankle restraints

### Attaching the X-restraint/XPR ankle restraints

For Model 6506 Power-PRO XT cots, Model 6086 Performance-PRO XT cots, and Model 6550 Power-PRO TL cots built or upgraded after July 3, 2015 with the Gatch option or any Trendelenburg only.

To attach the X-restraint/XPR ankle restraints (Figure 23):

1. Wrap the restraint around the cot litter.
2. Pull the restraint buckle through the loop, toward the head end of the cot.
3. Pull the buckle tight.
4. Connect the patient right buckle to the patient left buckle.
5. Remove any slack from the restraint strap loop.

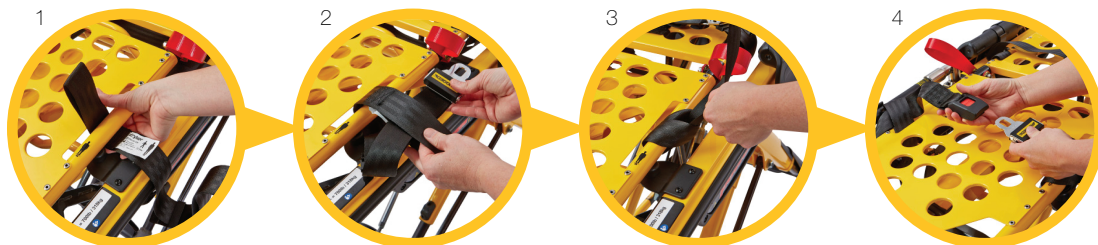

Figure 23 – Ankle restraints

### Securing the patient with the Pedi-Mate® infant restraint system

---

**WARNING** - Always locate the buckle away from obstructions or accessories on the cot to avoid the risk of accidental release of **Pedi-Mate®** infant restraint system and injury to the infant.

---

To secure the patient with the **Pedi-Mate®** infant restraint system:

1. Remove any restraints from the cot.
2. Raise the cot backrest to the full upright position.
3. Position the **Pedi-Mate®** pad flat on the cot backrest with the black backrest straps facing out.
4. Wrap the straps around the cot backrest and insert the ends of the straps through the brackets.
5. Fasten the buckle.

6. Pull on the end of the adjustable backrest strap to tighten.
7. Insert the mainframe straps between the product frame and the mattress.
8. Insert the buckle behind the litter cross brace and bring it up in front of the litter cross brace.
9. Fasten the buckle around the litter cross brace. Leave slack in the strap for final adjustment.
10. Tighten all straps.

**Note** - For more information about the **Pedi-Mate®** infant restraint system, see the manufacturer's instructions for use, operation, and care. Safe and proper use of the **Pedi-Mate®** infant restraint system is at the discretion of the user. Set methods and procedures to educate and train your staff on the safe operation or maintenance of this product. These are general instructions only. Keep these instructions for future reference. These instructions are a permanent part of the product and should remain with the product even if the product is sold.

**Pedi-Mate®** is a registered trademark of Ferno Washington, Inc.

## Attaching the defibrillator platform

---

**WARNING** - Do not attach the defibrillator platform on a Model 6086 **Performance-PRO XT** cot with the **Power-LOAD** option to avoid the risk of a cot tip.

---

### CAUTION

- Always secure the defibrillator platform to the product when you use the defibrillator platform.
  - Always use and adjust the straps that are provided with the defibrillator platform to secure the defibrillator.
  - Always change the attachment location or adjust the straps for your specific defibrillator size or shape.
  - Do not load the defibrillator platform above the safe working load of 30 lb (13.6 kg).
- 

To attach the defibrillator platform:

1. Place the defibrillator platform in the stored position (Figure 24).
2. Open and expand the defibrillator platform legs (Figure 25).

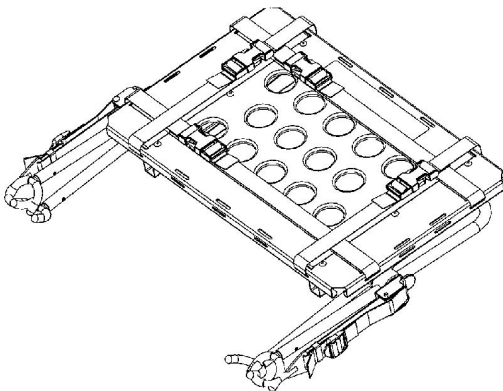

**Figure 24 – Stored position**

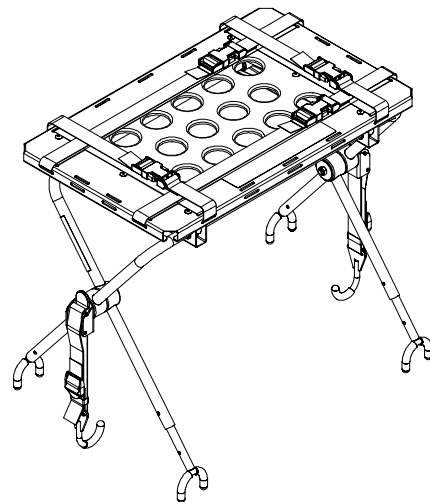

**Figure 25 – Open defibrillator platform legs**

3. If the product is equipped with an IV pole, raise the IV pole (A) to the up position (Figure 26).
4. Place the defibrillator platform on the product frame.
5. Position the inside legs (B) of the defibrillator platform toward the head end of the product (Figure 26).

6. Place the latch hook (C) under the litter frame or foot end fastener and push the tab (D) up until it locks into place on one side with an audible click (Figure 27). Repeat on the other side. For **Power-LOAD** compatible cots, if equipped, you must lengthen and attach the straps to the foot end fastener (Figure 28).

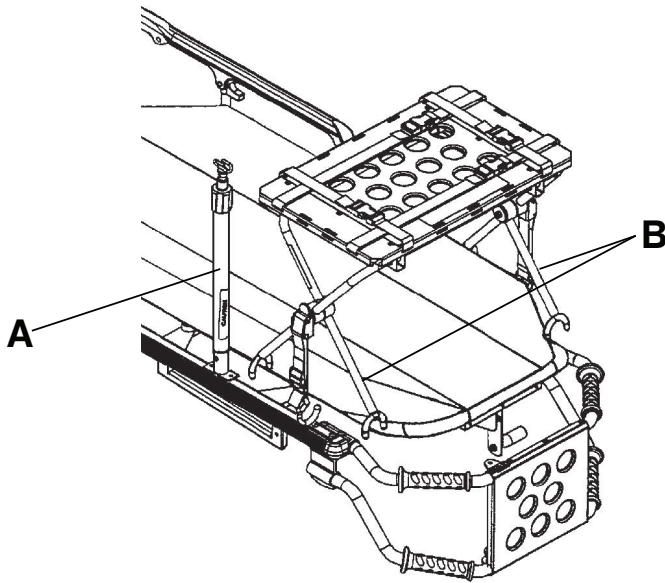

Figure 26 – Raise IV pole and position defibrillator tray (Model 6506 shown)

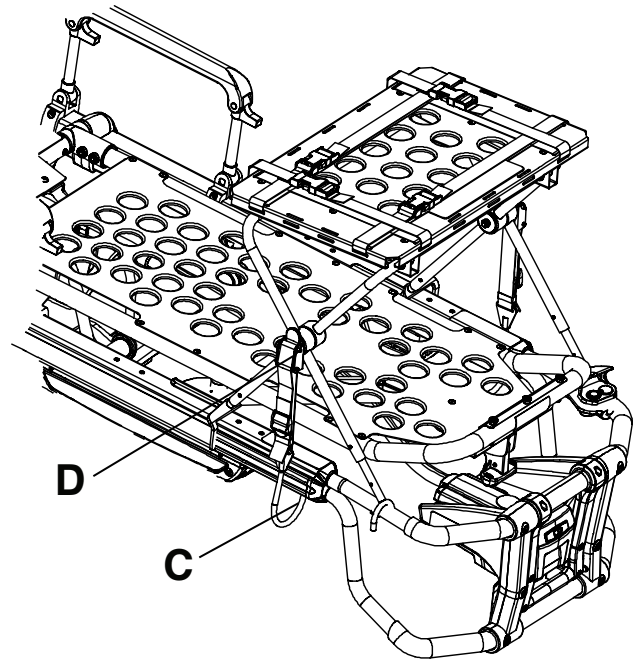

Figure 27 – Latch hook placement (Model 6506 shown)

7. Make sure that the defibrillator platform is secured to the product.
8. Place the defibrillator on the defibrillator platform.
9. Secure the straps (E) to hold the defibrillator on the defibrillator platform (Figure 29).



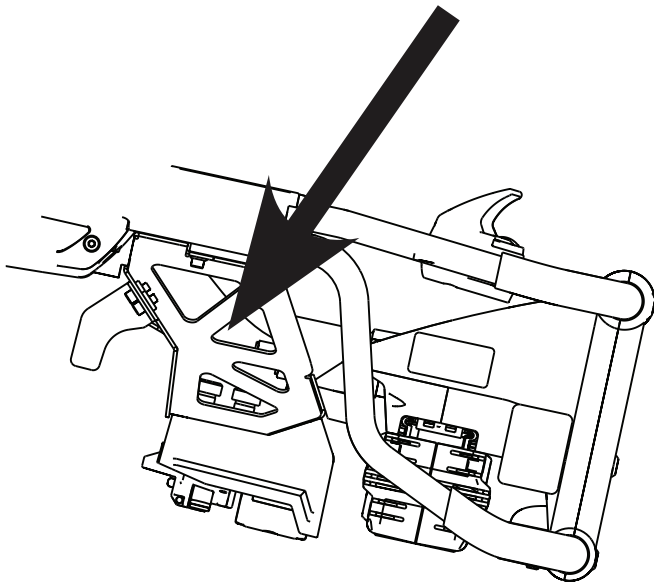

Figure 28 – Tab (Model 6506 shown)

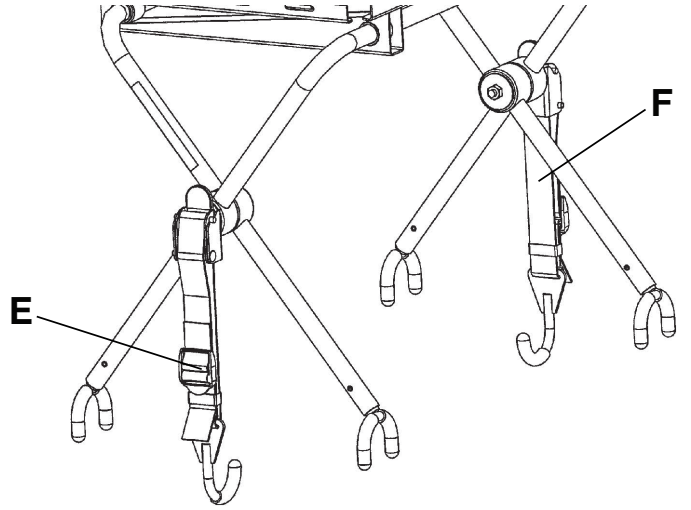

Figure 29 – Attach defibrillator platform to the cot

**Note** - If the defibrillator platform is not attached to the product after you connect both latch hooks, unlatch the tab. To adjust, loosen or tighten the strap and then push the tab up until it locks into place with an audible click.

## Hanging equipment from the equipment hook

Use the equipment hook to hang additional accessories or equipment, such as defibrillators and monitors.

---

### CAUTION

- Do not load the equipment hook above the safe working load of 35 lb (15.8 kg).
  - Always remove all accessories or equipment from the equipment hook when in the vehicle.
- 

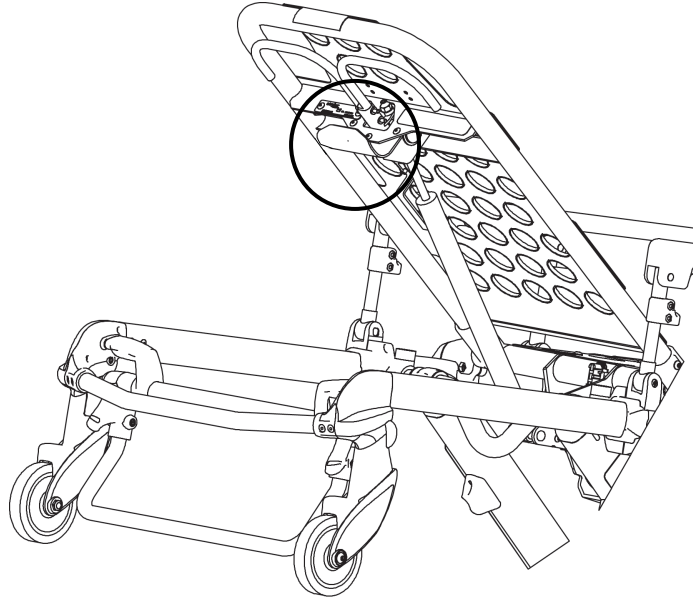

Figure 30 – Equipment hook

## Attaching the head extension with pillow

You can attach the head extension assembly on the backrest to provide head end support.

To attach the pillow to the head extension, place the support into the flap on the bottom of the pillow. Secure the pillow to the **Velcro®** on the bottom of the support.

### Note

- The head extension with pillow (6100-044-000) is not compatible with the equipment hook option (6500-147-000), Fowler oxygen bottle holder option (6500-241-000), or retractable head section oxygen bottle holder option (6085-046-000).
- The head extension pillow is a Type BF applied part.

## Positioning the two-stage IV pole

---

**CAUTION** - Do not load the IV pole above the safe working load of 25 lb (11.3 kg).

---

To position the IV pole (Figure 31):

1. Lift and pivot the IV pole from the storage position and push down until the IV pole locks into the receptacle (A).
2. To raise the height of the pole, turn the locking collar (B) counterclockwise and pull up on the telescoping portion (C) of the pole to raise it to the desired height.
3. Turn the locking collar (B) clockwise to lock the telescoping portion in place.
4. Hang the IV bags on the IV hook (D).
5. Turn the locking collars (B) counterclockwise and slide section (C) into the bottom tube.

6. Turn the locking collars (B) clockwise to tighten.
7. Lift up and pivot the pole down into the storage position (Figure 32).

**Note** - The dual two-stage IV poles (6500-312-000 or 6550-312-000) are not compatible with either the patient right (6500-310-000 or 6550-310-000) or the patient left (6500-311-000 or 6550-311-000) two-stage IV pole options.

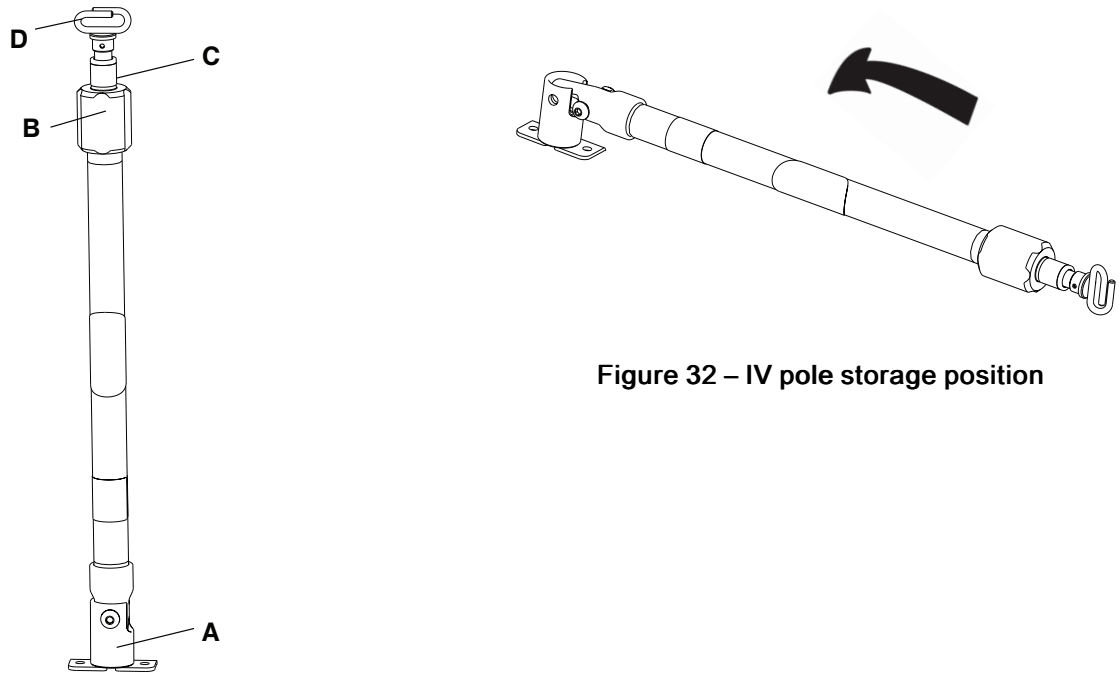

**Figure 31 – IV pole raised position**

**Figure 32 – IV pole storage position**

## Positioning the three-stage IV pole option

---

**CAUTION** - Do not load the IV pole above the safe working load of 25 lb (11.3 kg).

---

To position the IV pole (Figure 33):

1. Lift and pivot the IV pole from the storage position and push down until the IV pole locks into the receptacle (A).
2. To raise the height of the pole, turn the locking collar (B) counterclockwise and pull up on the telescoping portion (C) of the pole to raise it to the desired height.
3. Turn the locking collar (B) clockwise to lock the telescoping portion in place.
4. For a higher IV pole, pull up on section (D) until the spring clip (E) connects.
5. Hang the IV bags on the IV hook (F).
6. To lower the IV pole, push in on the spring clip (E) and slide section (D) down into section (C). Turn the locking collar (B) counterclockwise and slide section (C) into the bottom tube.
7. Turn the locking collar (B) clockwise to tighten.
8. Lift up and pivot the pole down into the storage position.

**Note** - The dual three-stage IV poles (6500-317-000 or 6550-317-000) are not compatible with either the patient right (6500-315-000 or 6550-315-000) or the patient left (6500-316-000 or 6550-316-000) three-stage IV pole options.

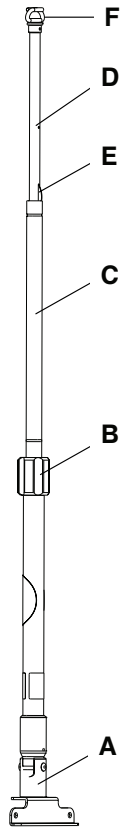

Figure 33 – IV pole raised position

## Attaching an oxygen bottle to the oxygen bottle holder

---

### WARNING

- Do not use the oxygen bottle holder to hold an oxygen bottle holder when the transport vehicle is in motion. Always place the oxygen bottle holder in an appropriate storage location when the transport vehicle is in motion.
  - Always inspect the straps and clips for wear between use. Replace the strap if it no longer holds the oxygen bottle.
- 

### CAUTION

- Do not load the oxygen bottle holder above the safe working load of 15 lb (6.8 kg).
  - Do not use two oxygen bottle holders at the same time.
- 

To attach an oxygen bottle to the oxygen bottle holder:

1. Place an oxygen bottle in the holder.
2. Insert the lower strap through the buckle and affix the strap onto itself to secure the oxygen bottle to the holder.

## Attaching an oxygen bottle to the retractable head section oxygen bottle holder

---

**WARNING** - Do not pinch your fingers between the Fowler bracket and the oxygen bottle if your cot is equipped with the retractable head section oxygen bottle holder option.

---

### CAUTION

- Do not load the oxygen bottle holder above the safe working load of 15 lb (6.8 kg).
  - Do not use two oxygen bottle holders at the same time.
-

To attach an oxygen bottle to the retractable head section oxygen bottle holder (Figure 34):

1. Center the oxygen bottle on the cradled surface of item (A).
2. Tighten both straps (B) around the oxygen bottle.
3. Secure the slack on the straps to the **Velcro®** on the straps.

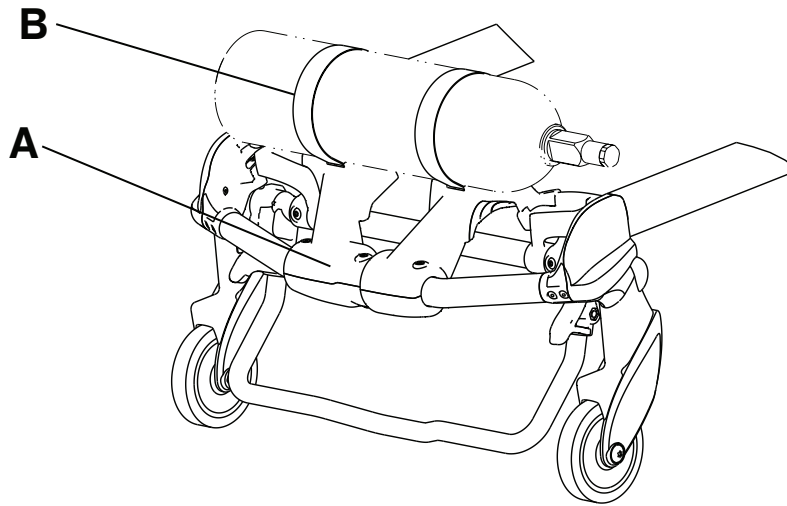

**Figure 34 – Oxygen bottle attachment**

#### **Note**

- The Fowler oxygen bottle holder option (6500-241-000) is not compatible with the retractable head section oxygen bottle holder option (6085-046-000).
- Do not use the oxygen bottle holder to hold an oxygen bottle holder when the transport vehicle is in motion. Always place the oxygen bottle holder in an appropriate storage location when the transport vehicle is in motion.
- Inspect the straps and clips for wear between use. Replace the strap if it no longer holds the oxygen bottle.

## **Attaching the base storage net option**

---

### **CAUTION**

- Do not load the base storage net above the safe working load of 20 lb (9 kg).
  - Always be careful when you retract the base to avoid damaging items that are stored in the base storage net.
- 

To attach the base storage net, wrap the **Velcro®** straps around the base tubes.

## **Attaching the backrest storage pouch**

---

### **CAUTION**

- Do not load the backrest storage pouch above the safe working load of 20 lb (9 kg).
  - Do not allow the storage pouch to interfere with the operation of the retractable head section.
- 

To attach the backrest storage pouch (Figure 35):

1. Insert each strap through a hole in the backrest skin.
2. Mount the pouch flat against the backrest.
3. Secure the backrest storage pouch to the cot with the **Velcro®** straps.

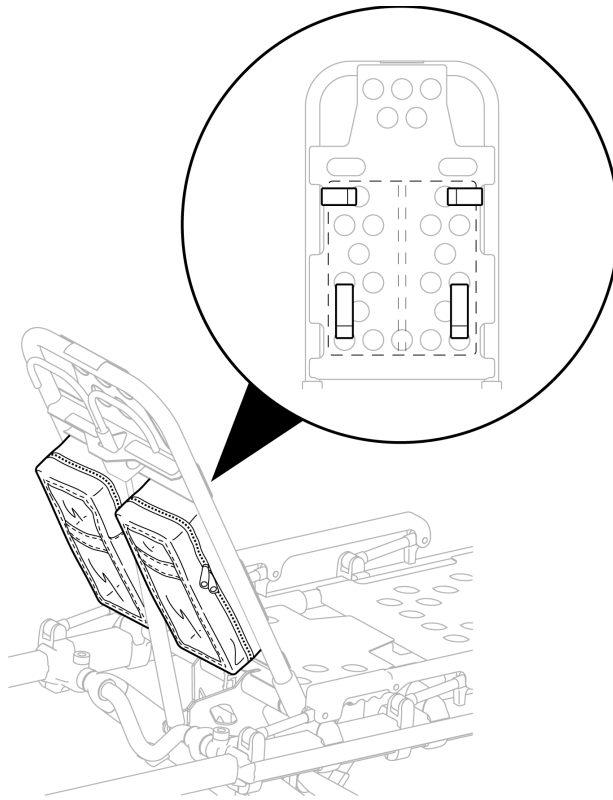

Figure 35 – Backrest storage pouch

## Attaching the head end storage flat option

---

**WARNING** - Do not allow the head end storage flat (if equipped) to interfere with the operation of the retractable head section, safety bar, or vehicle safety hook.

---

---

**CAUTION** - Do not load the head end storage flat above the safe working load of 40 lb (18 kg).

---

To attach the head end storage flat (Figure 36):

1. Install the **Velcro®** straps (A) near the pneumatic cylinder and around the cross tube (C) of the retractable head section.
2. Buckle the restraint straps (B) around the outer rails of the retractable head section.

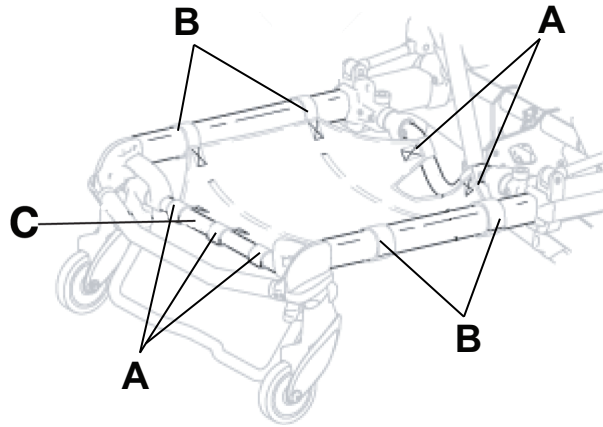

Figure 36 – Head end storage flat

## Attaching the mattress

---

**CAUTION** - Do not store items under the mattress. Items under the mattress may interfere with product operation.

---

Two mattress options are available for use with this product. Use the standard Gatch bolster (6500-002-150/6506-002-150) mattress with the standard siderail. Use the wider Gatch bolster mattress (6500-003-130/6506-003-130) with the expandable patient surface (XPS) option.

To attach the mattress to the cot:

1. Align the **Velcro®** on the back of the mattress with the **Velcro®** on the cot litter.
2. Attach the strap at the foot end of the mattress through the two holes in the foot end skin on the cot litter.
3. Pull the strap through the buckle and attach the **Velcro®** to secure the strap.

**Note** - The mattress is a Type BF applied part.

## Accessories and parts

These accessories may be available for use with your product. Confirm availability for your configuration or region. Call Stryker Customer Service: 1-800-327-0770.

Name	Number
Belt extension	6082-160-050
Equipment hook	6500-147-000
Head extension with pillow	6100-044-000
IV pole, two-stage, right	6500-310-000
IV pole, three-stage, right	6500-315-000
IV pole, three-stage, left	6500-316-000
Mattress, knee Gatch bolster	6506-034-000
Mattress, knee Gatch bolster, <b>XPS</b>	6500-003-130
Mattress, knee Gatch bolster, grey, <b>XPS</b>	6506-041-000
Oxygen bottle holder, foot end	6500-240-000
Oxygen bottle holder, head end	6500-241-000
Oxygen bottle holder, retractable head section	6085-046-000
Restraint bracket option	6091-300-010
Restraint package, G-rated	6500-002-030
Restraint package, X-restraint	6500-001-430
Restraint package, <b>XPR</b>	650600030010
Siderail, option	6086-058-000
Siderail, <b>XPS</b> option	6086-032-000
Storage flat, head end	6085-035-000
Storage net, base	6500-160-000
Storage pouch, backrest	6500-130-000



# Cleaning and disinfecting with SideKick®

For United States only. Confirm availability for your configuration or region. Call Stryker Customer Service: 1-800-327-0770.

Stryker's preferred wipes (2060-000-001 6" x 10" or 2060-000-002 9" x 12") and spray (2070-000-001) include the following active ingredients:

- n-Alkyl (60% C14, 30% C16, 5% C12, 5% C18) dimethyl benzyl ammonium chloride - 0.154%
- n-Alkyl (68% C12, 32% C14) dimethyl ethylbenzyl ammonium chloride - 0.154%
- Isopropanol - 21.000%

Non-active ingredient: Ethylene Glycol Monobutyl Ether – < 3%

**Note** - For safety information, read the product label.

## To clean or disinfect the external product surface with SideKick wipe:

### To clean:

1. Wipe down the external product surface with a fresh, clean wipe to remove all visible soils.
2. Repeat as necessary until the external product surface is visibly clean.
3. Wipe dry with a cloth or allow the external product surface to air dry before you return the product to service.

**Note** - Use as many wipes as necessary.

### To disinfect:

1. Clean first.
2. Wipe down the external product surface with a fresh, clean wipe until wet.
3. Allow the external product surface to remain wet for two minutes at room temperature.
4. Wipe dry with a cloth or allow the external product surface to air dry before you return the product to service.

## To clean or disinfect the external product surface with SideKick spray:

### To clean:

1. Spray **SideKick** on a mop, sponge, paper cloth, or cloth towel.
2. Wipe down the external product surface with a fresh, clean mop, sponge, paper cloth, or cloth towel to remove all visible soils.
3. Repeat as necessary until the external product surface is visibly clean.
4. Wipe dry with a cloth or allow the external product surface to air dry before you return the product to service.

### To disinfect:

1. Clean first.
2. Spray **SideKick** on a mop, sponge, paper cloth, or cloth towel.
3. Wipe down the external product surface with a fresh, clean mop, sponge, paper cloth, or cloth towel until wet.
4. Allow the external product surface to remain wet for two minutes at room temperature.
5. Wipe dry with a cloth or allow the external product surface to air dry before you return the product to service.

**Note** - Follow your hospital protocols to launder cloth towels or dispose of wipes or paper cloths.

# Cleaning and disinfecting the XPR restraint straps

Confirm availability for your configuration or region. Call Stryker Customer Service: 1-800-327-0770.

Suggested cleaners include:

- ≤ 70% isopropyl alcohol; or

A cleaner with the following active ingredients (or equivalent):

- Ammonium salts ≤ 0.31%
- Isopropyl alcohol ≤ 21.000%
- Ethylene glycol monobutyl ether ≤ 3.000% (non-active ingredient)

**Note** - Failure to use the prescribed cleaners may cause premature degradation and void the product's warranty. For example, do not clean with bleach, **HDQ Neutral®**, or accelerated hydrogen peroxide. If you have questions or concerns, please reach out to Stryker Customer Service (1-800-327-0770).

Recommended cleaning method:

1. Follow the cleaning solution manufacturer's dilution recommendations exactly.
2. To clean, wipe external surfaces to remove all visible soils. Repeat as necessary until the product is clean.

**Note** - Move the extension buckle to clean the entire restraint strap. Make sure that the restraint surface is dry before you move the extension buckle. Do not move the extension buckle over a surface that is wet with cleaner.

3. To disinfect, wipe external surfaces until wet.
4. Make sure that the product does not stay wet longer than the chemical manufacturer's guidelines for proper disinfecting.
5. Check functionality before you return the product to service.
  - Immersing restraint strap metal buckles can cause buckle corrosion and is not recommended. Rinse with clean water and allow to air dry to reduce chance of corrosion. Replace restraints if metal buckles are corroded.
  - Direct skin contact with visibly soiled, permeable material may increase the risk of infection.
  - Laundering the restraint straps is not recommended.

---

**CAUTION** - Do not apply lubricants to the surfaces of the restraints.

---

## Note

- XPR restraint straps have a three month expected service life when using the suggested cleaners shown above.
- Failure to follow the above directions when using these types of cleaners may void this product's warranty.
- Always wipe the product with clean water and dry after cleaning. Some cleaning products are corrosive in nature and may cause damage to the product. Failure to properly rinse and dry the product leaves a corrosive residue on the surface of the product and may cause premature degradation of critical components.

# Cleaning

---

**WARNING** - Always use any appropriate personal protective equipment while power washing to avoid inhaling contagion. Power washing equipment may aerate contamination.

---

## CAUTION

- Do not steam clean or ultrasonically clean the product.
  - Do not exceed 180 °F (82 °C) as the maximum water temperature.
  - Do not exceed 1500 psi (103.4 bar) as the maximum water pressure. If you use a hand held wand to wash the product, keep the pressure nozzle at a minimum of 24 in. (61 cm) from the product.
  - Always allow to air dry.
  - Always remove the battery before you wash the cot.
  - Do not clean, service, or perform maintenance while the product is in use.
- 

The product is power washable. The product may show some signs of oxidation or discoloration from continuous washing. No degradation of the product's performance will occur from power washing as long as you follow the proper procedures.

- Follow the cleaning solution manufacturer's dilution recommendations exactly.
- The preferred method Stryker Medical recommends for power washing the product is with the standard hospital surgical cart washer or hand held wand unit.
- Clean the cot once a month.
- Clean **Velcro®** after each use. Saturate **Velcro®** with disinfectant and allow disinfectant to evaporate. Appropriate disinfectant for nylon **Velcro®** should be determined by the service.
- Immersing restraint strap metal buckles can cause buckle corrosion and is not recommended. Rinse with clean water and allow to air dry to reduce chance of corrosion. Replace restraints if metal buckles are corroded.
- Direct skin contact with visibly soiled, permeable material may increase the risk of infection.

## Suggested cleaners

In general, when used in concentrations recommended by the manufacturer, either phenolic type or quaternary (excluding **Virex®** TB) type disinfectants can be used. Iodophor type disinfectants are not recommended for use because staining may occur.

Suggested cleaners include:

- Quaternary cleaners (active ingredient - ammonium chloride) that contain less than 3% glycol ether
- Phenolic cleaners (active ingredient - o-phenylphenol)
- Chlorinated bleach solution (5.25% - less than 1 part bleach to 100 parts water)
- ≤ 21% isopropanol alcohol

Avoid oversaturation. Do not allow the product to stay wet longer than the chemical manufacturer's guidelines for proper disinfecting.

## Note

- Failure to follow the above directions when using these types of cleaners may void this product's warranty.
- Always wipe the product with clean water and dry after cleaning. Some cleaning products are corrosive in nature and may cause damage to the product. Failure to rinse and dry the product leaves a corrosive residue on the surface of the product and may cause premature corrosion of critical components.

# Preventive maintenance

**CAUTION** - Always use authorized parts to avoid the risk of product damage.

Establish and follow a maintenance schedule and keep records of the maintenance activity. Remove product from service before you perform the preventive maintenance inspection. You may need to perform preventive maintenance checks more often based on your level of product usage. Service only by qualified personnel.

When using maintenance products, follow the directions of the manufacturer and reference all material safety data sheets (MSDS).

## Regular inspection and adjustments

The following schedule is a general guide to maintenance. Factors such as weather, terrain, geographical location, and individual usage will alter the required maintenance schedule. If you are unsure how to perform these checks, contact your Stryker service technician. If you are in doubt as to what intervals to follow to maintain your product, consult your Stryker service technician. Check each routine and replace worn parts if necessary.

### Every month or two hours

Inspect these items every month or two hours of motor run time, whichever comes first.

Item	Inspect
Manual backup release handle	Manual backup release handle functions
Litter	Frame and litter
Base	Frame and base
Wheels	All wheels are secure, roll, and swivel
Head section	Safety bar operates. Pull toward the head section to make sure that the safety bar swings and rotates freely and pulls back to the home position
Restraint	Restraints function with no excessive wear (such as a bent or broken receiver or latch plate or torn or frayed webbing)

### Every three months or six hours

Inspect these items every three months or six hours of motor run time, whichever comes first.

Item	Inspect
Manual backup release handle	Base extends and retracts when you pull the manual backup release handle
	Cot does not lower when you pull the manual backup release handle with 100 lb (45 kg) or more on the cot
Litter	All fasteners are secure
	Backrest cylinder operates
	Adjust pneumatic cylinder for full range of motion, if required
	Dead stop (6085-001-094) for wear
Base	All fasteners are secure

Item	Inspect
X-frame	X-frame expands and retracts
Kickstand (option)	Retracts fully to the transport position
	Bolts are tightened
Head section	All fasteners are secure
	Head section extends and locks
Accessories and parts	All accessories and parts operate (such as IV pole, head extension and pillow, and restraint extender)

### Every six months or 12 hours

Inspect these items every six months or 12 hours of motor run time, whichever comes first.

Item	Inspect
Litter	No bent, broken, or damaged components
	No damage or tears on cot grips
	Siderails operate and latch
	Foot rest operates
Mattress	No cracks or tears
Base	No bent, broken, or damaged components
	Cot retaining post is secure. If not, replace the screw
	No excessive damage to X-frame guards
Wheels	Free of debris
Head section	No bent, broken, or damaged components
	Grip bar has no excessive damage or tears
	Load wheels are secure and roll
Kickstand (option)	Lubricate the kickstand spring and internal spring housing using <b>Tri-Flow®</b> lubrication.

### Every 12 months or 24 hours

Inspect these items every 12 months or 24 hours of motor run time, whichever comes first.

Item	Inspect
Settings	Cot and fastener fit and function
	Safety bar connects to the vehicle safety hook
Manual backup release handle	Returns to the stowed position
Litter	All welds are intact, not cracked, or broken
	Warning labels present, legible

Item	Inspect
	Fowler bumper and screws
Base	All welds are intact, not cracked, or broken
Wheels	Check and adjust wheel locks
Retractable head section oxygen bottle holder (option)	Straps and clips for wear
Defibrillator platform (option)	Straps not frayed or torn
	Latch hooks are intact and secure

### Foot end fastener part replacement schedule

For **Performance-LOAD** compatible cots, you must replace the foot end fastener parts every 18,078 calls. This is to make sure that the **Performance-LOAD** remains functional. Follow this call volume time table to remain compliant with this requirement.

Calls per day	Months
≤ 7	Not applicable
8	77
9	67
10	59



# stryker



Stryker Medical  
3800 E. Centre Avenue  
Portage, MI 49002  
USA