

Nära® Hospital Bassinet

Operations Manual

REF 4402-000-001

REF 4402-000-002



Symbols













	Consult instructions for use
	General warning
	Warning; crushing of hands
	Caution
	Catalogue number
	Serial number
	Quantity
	Unit number
	For US Patents see www.stryker.com/patents
	Manufacturer
	Date of manufacture
	Safe working load
	Do not place infant / newborn on this surface

Table of Contents

Warning/Caution/Note Definition	2
Summary of safety precautions	2
Pinch points.....	3
Introduction	4
Product description	4
Intended use	4
Contraindications	4
Expected device life	4
Specifications	5
Product illustration	6
Contact information.....	6
Serial number location.....	7
Unit number.....	7
Setup.....	7
Operation	8
Attaching and latching the basket to the base cabinet	8
Removing the basket from the base cabinet.....	9
Accessing the infant / newborn from the basket	9
Tilting the basket.....	10
Raising and lowering the bassinet	10
Opening and closing the retractable work surface.....	11
Opening and closing the two-way drawers	11
Storing records in the chart holder.....	12
Applying and releasing the caster locks	13
Applying and releasing the steer caster.....	13
Transporting the bassinet	13
Applying the name card (optional)	14
Accessories and parts	15
Cleaning and disinfecting with wipes.....	16
Cleaning.....	17
Disinfecting	18
Preventive maintenance	19

Warning/Caution/Note Definition

The words **WARNING**, **CAUTION**, and **NOTE** carry special meanings and should be carefully reviewed.

WARNING

Alerts the reader about a situation which, if not avoided, could result in death or serious injury. It may also describe potential serious adverse reactions and safety hazards.

CAUTION

Alerts the reader of a potentially hazardous situation which, if not avoided, may result in minor or moderate injury to the user or patient or damage to the product or other property. This includes special care necessary for the safe and effective use of the device and the care necessary to avoid damage to a device that may occur as a result of use or misuse.

Note - Provides special information to make maintenance easier or important instructions clearer.

Summary of safety precautions

Carefully read and strictly follow the warnings and cautions listed on this page. Service only by qualified personnel.

WARNING

- To avoid tipping hazards of this device, make sure that the basket and accessories sit firmly in the base and that all doors, drawers, and casters are secure.
 - Do not add extra padding to avoid the risk of infant / newborn injury.
 - Only use the pad provided by the manufacturer. Never add a pillow, comforter, or another mattress for padding.
 - Do not exceed the safe working load of the drawers, basket, retractable work surface, or chart holder.
 - Always remove the infant / newborn from the basket before removing the basket from the base cabinet to avoid the risk of patient fall.
 - Do not raise the hospital bed when the bassinet is near, to avoid interference that may cause instability or tipping.
 - Do not place items above or below the functional areas of the bassinet.
 - Do not push the product from the sides, to avoid instability.
 - Do not lift the bassinet by the basket or by the adjustment bar.
 - Always disinfect the mattress between infant / newborns to avoid the risk of cross-contamination and infection.
 - Do not immerse the mattress in cleaning or disinfectant solutions.
 - Do not allow liquids to pool on the mattress.
 - Always completely dry the mattress, basket, and bassinet before storing, adding linens, or placing a infant / newborn in the basket. Drying the product helps to prevent the performance of the product from being impaired.
-

CAUTION

- Improper usage of the product can cause injury to the patient or operator. Operate the product only as described in this manual.
- Do not modify the product or any components of the product. Modifying the product can cause unpredictable operation resulting in injury to patient or operator. Modifying the product also voids its warranty.
- Do not remove or install the basket while occupied.
- Do not place an infant / newborn in the drawers, on the retractable work surface, or on the base cabinet.
- Do not place items between the basket and the base cabinet.
- Do not carry the basket with the tilt bar.
- Do not use this product to perform medical procedures.
- Always remove the infant / newborn from the basket before removing the basket from the base cabinet to avoid the risk of patient fall.
- Do not hang items on the adjustment bar or handles.
- Always close the drawers flush with the base cabinet when not in use.

- Do not push the drawer to the opposite side of the bassinet.
 - Do not push or steer the product with the basket, to avoid instability.
 - Do not push the product with the basket tilted.
 - Do not use the product on ramps or slopes that are greater than 5.7 degrees to avoid instability.
 - Do not apply the caster locks to stop the bassinet while in transport.
 - Do not operate the product on soft or unstable surfaces, such as sand, grass, or gravel, to avoid instability or difficult mobility.
 - Do not attempt to transport with caster locks applied.
 - Always apply the name card to the outside of the basket to avoid the risk of choking.
 - Do not clean, service, or perform maintenance while the product is in use.
 - Do not use accelerated hydrogen peroxides or Virex cleaners that are ether based as they may damage the product.
 - Always make sure that you wipe each product with clean water and thoroughly dry each product after cleaning. Some cleaning products are corrosive in nature and may cause damage to the product if you use them improperly. If you do not rinse and dry the product, you may leave a corrosive residue on the surface of the product. Failure to follow these cleaning instructions may void your warranty.
 - Do not over expose the product to higher concentration disinfectant solutions as these may degrade the product.
 - Always make sure that you wipe each product with clean water and thoroughly dry each product after cleaning. Some cleaning agents are corrosive in nature and may cause damage to the product if you use them improperly. If you do not properly rinse and dry the product, a corrosive residue may be left on the surface of the product that could cause premature degradation of critical components. Failure to follow these cleaning instructions may void your warranty.
-

Pinch points

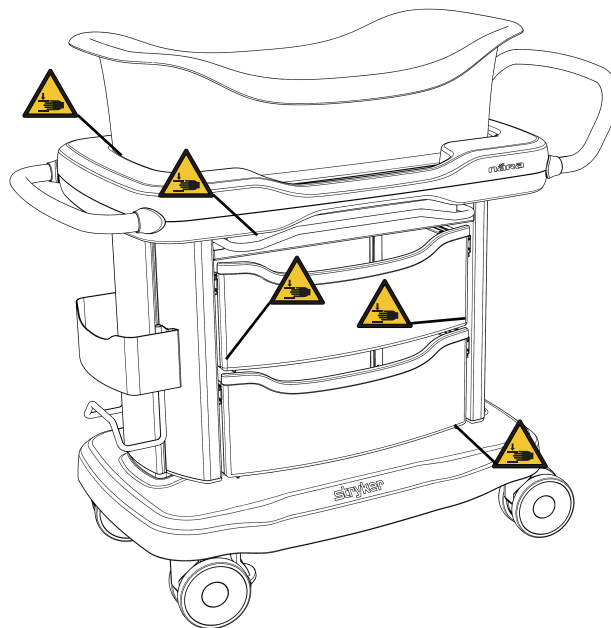

Introduction

This manual assists you with the operation or maintenance of your Stryker product. Read this manual before operating or maintaining this product. Set methods and procedures to educate and train your staff on the safe operation or maintenance of this product.

CAUTION

- Improper usage of the product can cause injury to the patient or operator. Operate the product only as described in this manual.
 - Do not modify the product or any components of the product. Modifying the product can cause unpredictable operation resulting in injury to patient or operator. Modifying the product also voids its warranty.
-

Note

- This manual is a permanent part of the product and should remain with the product even if the product is sold.
- Stryker continually seeks advancements in product design and quality. This manual contains the most current product information available at the time of printing. There may be minor discrepancies between your product and this manual. If you have any questions, contact Stryker Customer Service or Technical Support at 1-800-327-0770.

Product description

The Stryker model 4402 **Nära**® Hospital Bassinet consists of a base cabinet, two- way drawers, retractable work surface, five inch soft-wheel casters, a clear basket, and mattress. The basket allows for easy access to the infant / newborn patient, tilts, and latches securely onto the base cabinet.

Intended use

The **Nära** Hospital Bassinet is a sleeping surface for infant / newborn patients from birth to five months of age. The product has a tilting basket to allow visibility of the patient by hospital staff and family members. The top surface of the device raises and lowers to allow easier access to the infant / newborn. The product can come in contact with healthy skin.

This product is for use with infant / newborn patients as a sleeping surface.

The bassinet is for use in infant / newborn clinical care settings; such as:

- Labor and delivery units
- Neonatal intensive care units
- Other patient care rooms

This product is not intended for patients that can crawl or reposition themselves independently.

Contraindications

None known.



Expected device life

The **Nära** Hospital Bassinet has a five year expected service life under normal use conditions and with appropriate periodic maintenance.

Specifications

Safe working load 	Mattress	12 lb (5.4 kg)
	Basket	12 lb (5.4 kg)
	Each drawer	5 lb (2.3 kg)
	Retractable work space	5 lb (2.3 kg)
	Chart holder	5 lb (2.3 kg)

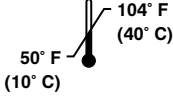
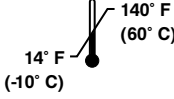
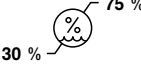
Description	Length	Width	Height
Bassinet base	33 in. (83.8 cm)	21 in. (53.3 cm)	n/a
Basket	26.5 in. (67.3 cm)	12.5 in. (31.7 cm)	7.5 in. (19.0 cm)
Two-way drawer (each)	19.25 in. (48.8 cm)	13.75 in. (34.9 cm)	6.25 in. (15.8 cm)
Retractable work space	11.5 in. (29.2 cm)	10 in. (25.4 cm)	n/a
Chart holder	10 in. (25.4 cm)	2.75 in. (6.9 cm)	13.5 in. (34.2 cm)
Mattress	26 in. (66.04 cm)	12 in. (30.48 cm)	1.5 in. (3.81 cm)
Mattress material	Polyester fiber 100% all new material		
Adjustable height	30.5 in. to 39.5 in. (77.4 to 100 cm)		

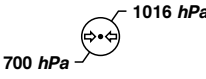
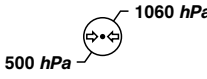
Environmental conditions	Operation	Storage and transportation
Ambient temperature		
Relative humidity (non-condensing)		
Atmospheric pressure		

Stryker reserves the right to change specifications without notice.

Product illustration

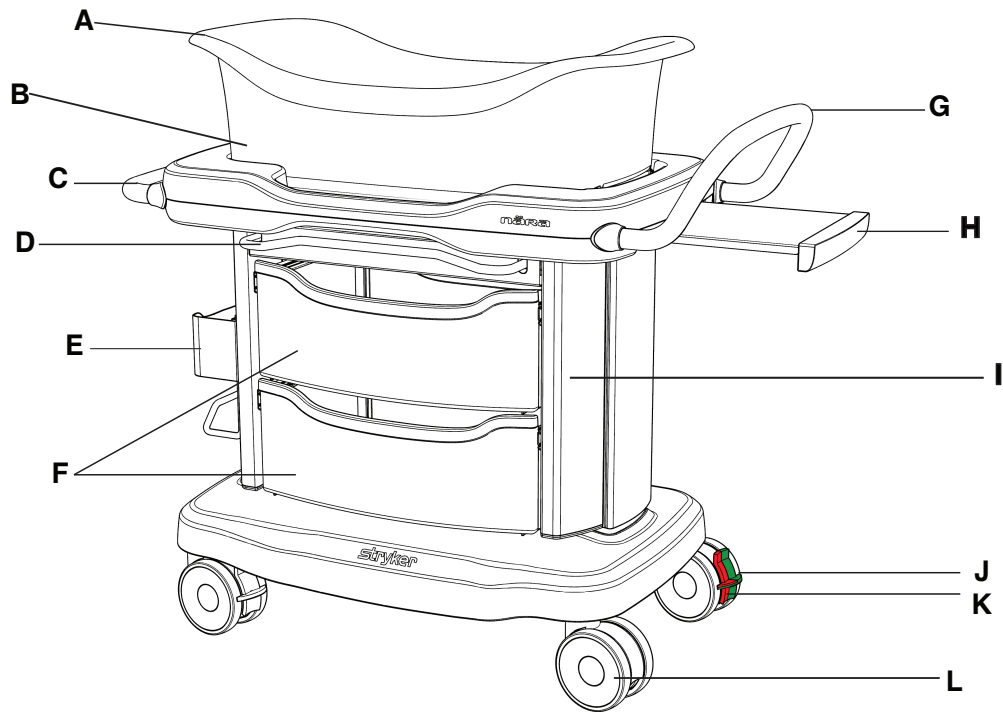

A	Basket	G	Transport handle
B	Mattress	H	Retractable work surface
C	Reposition handle	I	Narrow base cabinet
D	Height adjustment bar, both sides	J	Steer lock, green
E	Chart holder	K	Caster locks, red
F	Two-way drawers	L	5" dual soft-wheel casters

Contact information

Contact Stryker Customer Service or Technical Support at: 1-800-327-0770.

Stryker Medical
 3800 E. Centre Avenue
 Portage, MI 49002
 USA

To view your operations or maintenance manual online, see <https://techweb.stryker.com/>.

Have the serial number (A) of your Stryker product available when calling Stryker Customer Service or Technical Support. Include the serial number in all written communication.

Serial number location

You can find the serial number inside the cabinet (A), opposite the chart holder (Figure 1).

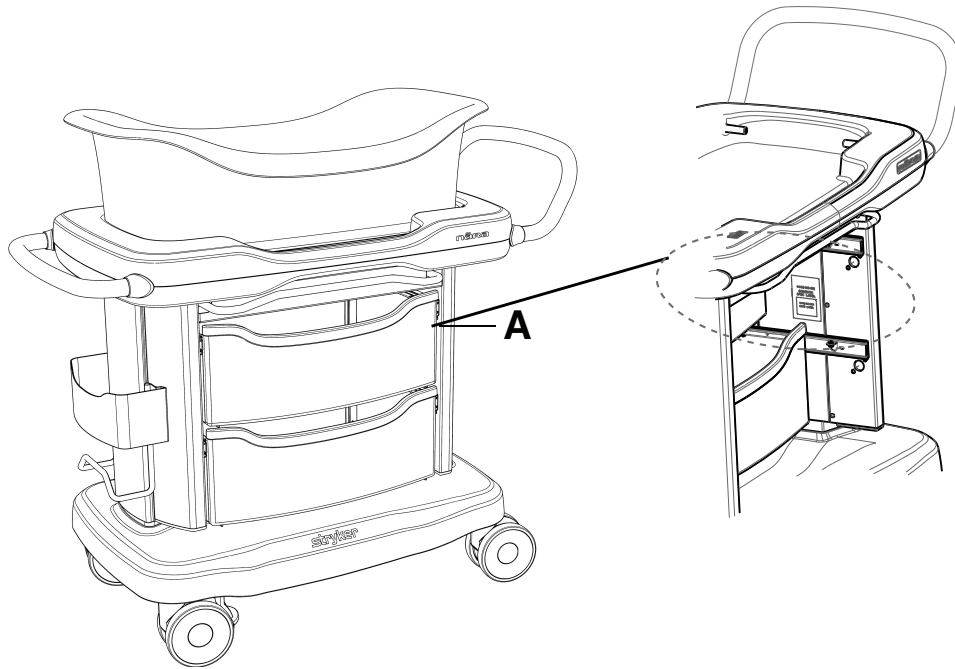
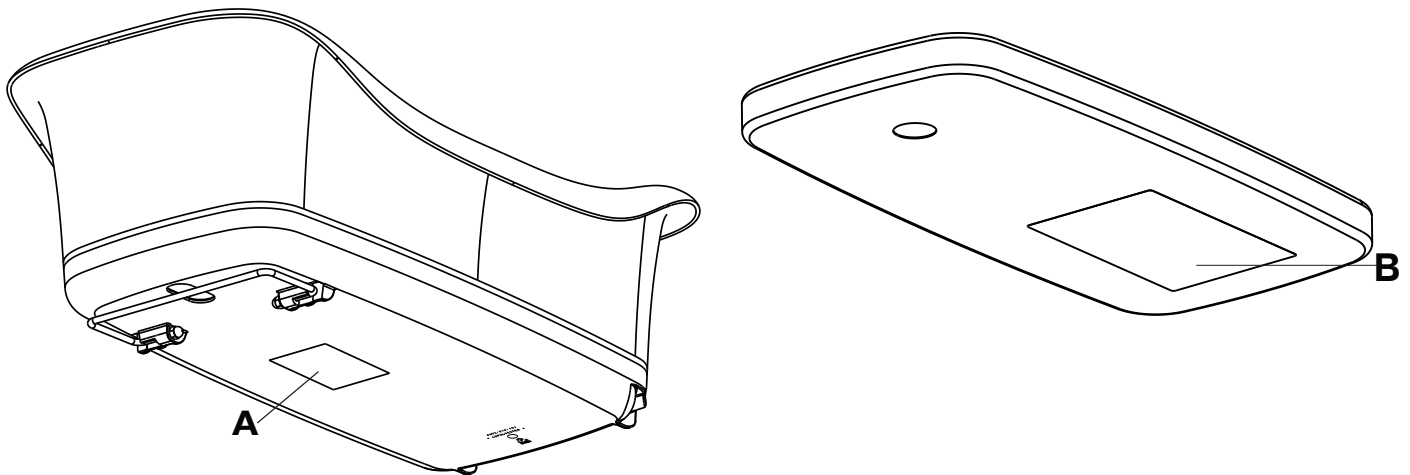

Figure 1 – Serial number location

Unit number

Have the unit number of your basket (A) or mattress (B) available when calling Stryker Customer Service or Technical Support. Include the unit number in all written communication.



Setup

During setup, unpack the cartons and check all items for proper operation. Make sure that the product is working properly before it is put into service.

Remove all shipping and packaging materials from the product prior to use.

Operation

Attaching and latching the basket to the base cabinet

The basket attaches to the base cabinet at three secure points of contact.

WARNING

- To avoid tipping hazards of this device, make sure that the basket and accessories sit firmly in the base and that all doors, drawers, and casters are secure.
 - Do not add extra padding to avoid the risk of infant / newborn injury.
 - Only use the pad provided by the manufacturer. Never add a pillow, comforter, or another mattress for padding.
 - Do not exceed the safe working load of the drawers, basket, retractable work surface, or chart holder.
-

CAUTION

- Do not remove or install the basket while occupied.
 - Do not place an infant / newborn in the drawers, on the retractable work surface, or on the base cabinet.
 - Do not place items between the basket and the base cabinet.
 - Do not carry the basket with the tilt bar.
 - Do not use this product to perform medical procedures.
-

Note - The bassinet is not for use as a step or a shelf.

To attach and latch the basket to the bassinet:

1. Tilt the basket to align the notches on the bottom of the basket to the two retention pins on the base cabinet (A) (Figure 2).
2. Slide the basket onto the two retention pins (Figure 3).
3. Slide the tilt bar under the metal bracket until the bar is secure (B) (Figure 2).

Note - Confirm proper attachment by observing the yellow retention pins through the window in the basket.

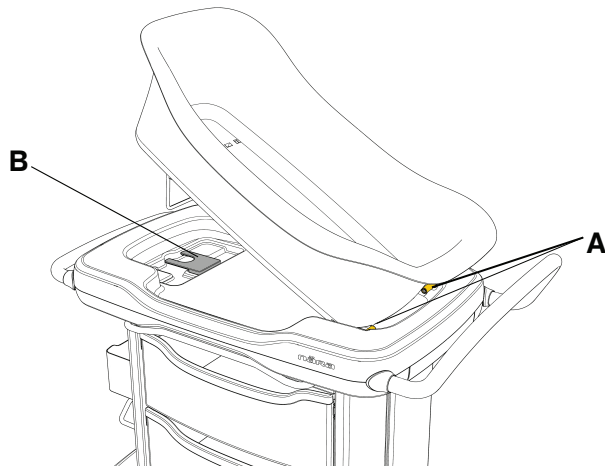

Figure 2 – Attach and latch the basket onto the base cabinet

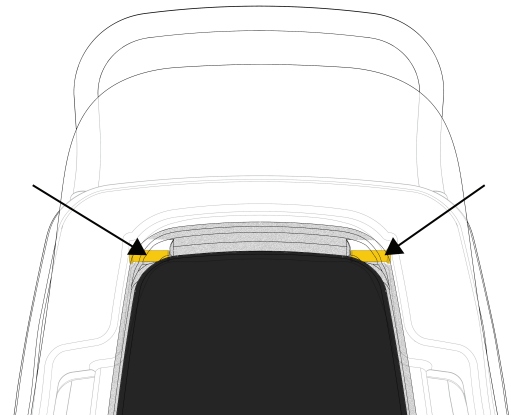

Figure 3 – Retention pins

Removing the basket from the base cabinet

WARNING

- Do not exceed the safe working load of the drawers, basket, retractable work surface, or chart holder.
 - Always remove the infant / newborn from the basket before removing the basket from the base cabinet to avoid the risk of patient fall.
-

CAUTION - Do not place an infant / newborn in the drawers, on the retractable work surface, or on the base cabinet.

To remove the basket from the base cabinet:

1. Remove the infant / newborn from the basket.
2. Remove the mattress from the basket.
3. Reach through the cut-out window on the basket, then grasp and lift the tilt bar.
4. Tilt the basket upward and slide basket off the two retention pins.

Accessing the infant / newborn from the basket

WARNING - Do not exceed the safe working load of the drawers, basket, retractable work surface, or chart holder.

The basket is curved on the sides to allow for access to the infant / newborn (Figure 4).

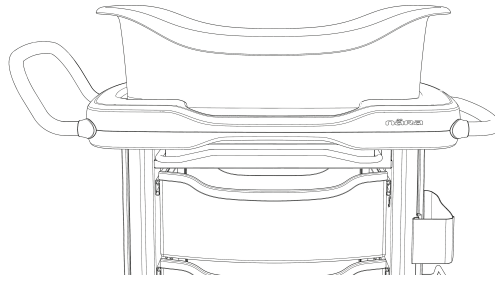

Figure 4 – Basket

Tilting the basket

CAUTION - Always remove the infant / newborn from the basket before removing the basket from the base cabinet to avoid the risk of patient fall.

1. To tilt the basket upward, grasp basket at the logo and lift upward until the tilt bar slides into the slot. (Figure 5).

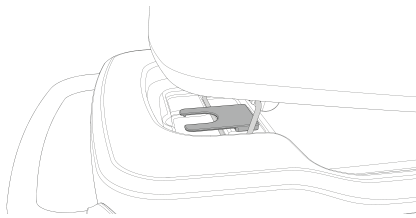

Figure 5 – Tilt bar secured in the elevated position

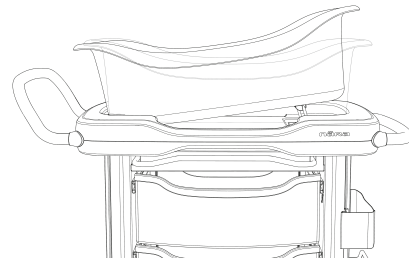

Figure 6 – Tilt the basket

2. To lower the basket to a flat position, grasp the basket at the logo.
3. Lift the basket slightly and lift the tilt bar from the slot (Figure 6).
4. Lower the basket.

Raising and lowering the bassinet

WARNING

- To avoid tipping hazards of this device, make sure that the basket and accessories sit firmly in the base and that all doors, drawers, and casters are secure.
 - Do not raise the hospital bed when the bassinet is near, to avoid interference that may cause instability or tipping.
 - Do not place items above or below the functional areas of the bassinet.
-

CAUTION - Do not hang items on the adjustment bar or handles.

1. To raise the bassinet, squeeze the height adjustment bar with both hands upward toward the handle (Figure 7). Apply force upward to raise the bassinet to the desired position (Figure 8).

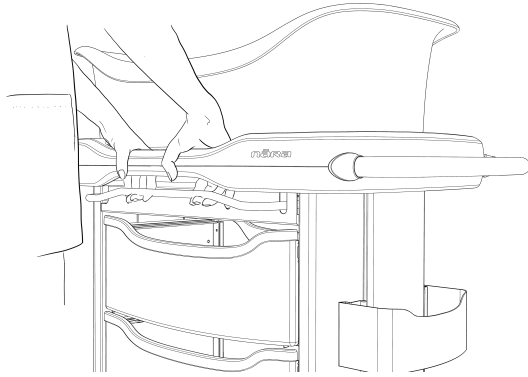

Figure 7 – Height adjustment bar



Figure 8 – Raise or lower the bassinet

2. To lower the bassinet, squeeze the height adjustment bar with both hands upward toward the handle (Figure 7). Apply force downward to lower the bassinet to the desired position (Figure 8).

Opening and closing the retractable work surface

WARNING

- To avoid tipping hazards of this device, make sure that the basket and accessories sit firmly in the base and that all doors, drawers, and casters are secure.
 - Do not exceed the safe working load of the drawers, basket, retractable work surface, or chart holder.
-

CAUTION - Do not place an infant / newborn in the drawers, on the retractable work surface, or on the base cabinet.

To open or close the retractable work surface:

1. To open the retractable work surface, pull outward.

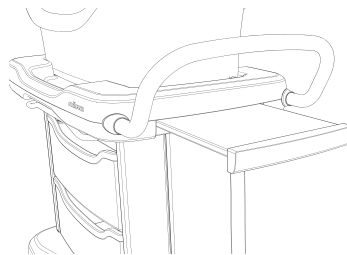

Figure 9 – Open or close the retractable work surface

2. To close the retractable work surface, push inward.

Opening and closing the two-way drawers

Nära Hospital Bassinet has two-way drawers that allow access from either side of the bassinet.

WARNING

- To avoid tipping hazards of this device, make sure that the basket and accessories sit firmly in the base and that all doors, drawers, and casters are secure.

- Do not exceed the safe working load of the drawers, basket, retractable work surface, or chart holder.
-

CAUTION

- Do not place an infant / newborn in the drawers, on the retractable work surface, or on the base cabinet.
 - Always close the drawers flush with the base cabinet when not in use.
 - Do not push the drawer to the opposite side of the bassinet.
-

Note - Drawers are for storage, not for use as steps or a shelf.

1. To open the two-way drawers, grasp the center of the drawer and pull outward from either side of the bassinet.

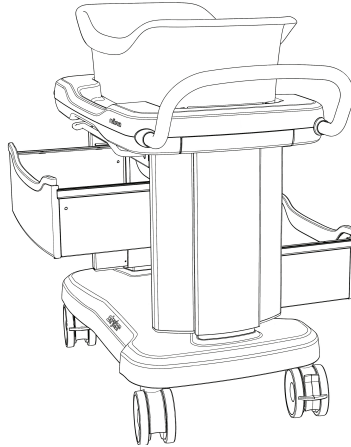

Figure 10 – Two-way drawers

2. To close the two-way drawers, push the drawer inward.

Note

- There is a magnetic detent in the middle of the drawer that helps to center the drawer when closed.
 - Do not overfill the drawers, it may prevent closure.
3. Make sure the drawers are closed before moving the device.

Storing records in the chart holder

WARNING

- To avoid tipping hazards of this device, make sure that the basket and accessories sit firmly in the base and that all doors, drawers, and casters are secure.
 - Do not exceed the safe working load of the drawers, basket, retractable work surface, or chart holder.
-

Use the chart holder to store and transport infant / newborn records (Figure 11).

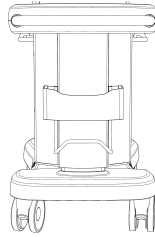

Figure 11 – Chart holder

Applying and releasing the caster locks

1. To apply the caster lock, push down on the red pedal with your foot.
2. To release the caster lock, lift up on the red pedal with your foot.

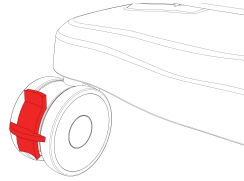

Figure 12 – Rear caster lock

Applying and releasing the steer caster

The steer caster aids the operator when transporting the bassinets. Applying the steer caster forces the caster to move straight instead of allowing it to turn.

1. To apply the steer caster, push down on the green caster pedal with your foot.

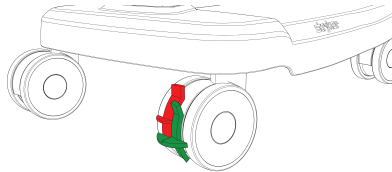

Figure 13 – Apply the casters for steering

2. To release the steer caster, lift up on the green caster pedal with your foot.

Transporting the bassinets

WARNING

- To avoid tipping hazards of this device, make sure that the basket and accessories sit firmly in the base and that all doors, drawers, and casters are secure.
 - Do not push the product from the sides, to avoid instability.
 - Do not lift the bassinets by the basket or by the adjustment bar.
-

CAUTION

- Do not push or steer the product with the basket, to avoid instability.
- Do not push the product with the basket tilted.
- Do not use the product on ramps or slopes that are greater than 5.7 degrees to avoid instability.
- Do not apply the caster locks to stop the bassinets while in transport.

- Do not operate the product on soft or unstable surfaces, such as sand, grass, or gravel, to avoid instability or difficult mobility.
 - Do not attempt to transport with caster locks applied.
-

1. Make sure that the basket is not tilted.
2. Release the caster pedal lock.
3. Apply the steer caster, if applicable.
4. Grasp the transport handle and push the bassinet forward.

Applying the name card (optional)

CAUTION - Always apply the name card to the outside of the basket to avoid the risk of choking.

1. Write on the name card with permanent marker.
2. Peel the name card and apply to the outside of the basket.

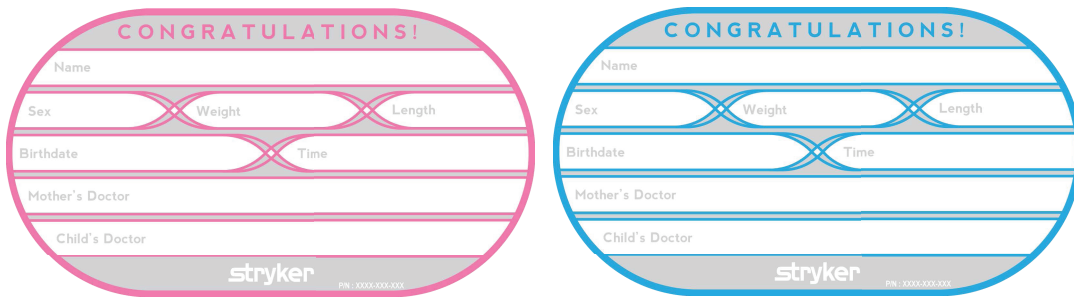

Figure 14 – Name card

Accessories and parts

These accessories may be available for use with your product. Confirm availability for your configuration or region. Call Stryker Customer Service: 1-800-327-0770.

Name	Number
Basket	4402-010-011
Mattress	4402-031-003
Basket, International	4402-010-031
Mattress, International	4402-031-007

Cleaning and disinfecting with wipes

For United States only. Confirm availability for your configuration or region. Call Stryker Customer Service: 1-800-327-0770.

Stryker's preferred wipes (2060-000-001 6" x 10" or 2060-000-002 9" x 12") include the following active ingredients:

- n-Alkyl (60% C14, 30% C16, 5% C12, 5% C18) dimethyl benzyl ammonium chloride - 0.154%
- n-Alkyl (68% C12, 32% C14) dimethyl ethylbenzyl ammonium chloride - 0.154%
- Isopropanol - 21.000%

Non-active ingredient: Ethylene Glycol Monobutyl Ether – < 3%

Note - For safety information, read the product label.

To clean or disinfect the external product surface:

1. To clean, wipe external surfaces with a fresh, clean wipe to remove all visible soils. Repeat as necessary until the product is clean.

Note

- Use as many wipes as necessary.
 - Complete step 1 before you disinfect.
2. To disinfect, wipe external surfaces with a fresh, clean wipe until wet. Allow the external surface to remain wet for two minutes at room temperature.
 3. Allow the product to dry before you return it to service.

Cleaning

WARNING

- Always disinfect the mattress between infant / newborns to avoid the risk of cross-contamination and infection.
 - Do not immerse the mattress in cleaning or disinfectant solutions.
 - Do not allow liquids to pool on the mattress.
 - Always completely dry the mattress, basket, and bassinet before storing, adding linens, or placing a infant / newborn in the basket. Drying the product helps to prevent the performance of the product from being impaired.
-

CAUTION

- Do not clean, service, or perform maintenance while the product is in use.
 - Do not use accelerated hydrogen peroxides or Virex cleaners that are ether based as they may damage the product.
 - Always make sure that you wipe each product with clean water and thoroughly dry each product after cleaning. Some cleaning products are corrosive in nature and may cause damage to the product if you use them improperly. If you do not rinse and dry the product, you may leave a corrosive residue on the surface of the product. Failure to follow these cleaning instructions may void your warranty.
-

Tools Required:

- Mild anti-bacterial soap
 - Soft, lint free cloth (2 or more)
1. Apply the caster locks.
 2. Prepare a mild soap and warm water solution.
 3. Wipe the inside and outside of the basket and mattress with a soft, lint free cloth moistened with soap and water solution.
 4. Wipe all the bassinet surfaces, with a soft, lint free cloth moistened with soap and water solution.
 5. Wipe off excess moisture from all surfaces with a dry, soft, lint free cloth.
 6. Allow the surfaces of the basket and bassinet to dry thoroughly.

Disinfecting

WARNING

- Always disinfect the mattress between infant / newborns to avoid the risk of cross-contamination and infection.
 - Do not immerse the mattress in cleaning or disinfectant solutions.
 - Do not allow liquids to pool on the mattress.
 - Always completely dry the mattress, basket, and bassinet before storing, adding linens, or placing a infant / newborn in the basket. Drying the product helps to prevent the performance of the product from being impaired.
-

CAUTION

- Do not over expose the product to higher concentration disinfectant solutions as these may degrade the product.
 - Do not use accelerated hydrogen peroxides or Virex cleaners that are ether based as they may damage the product.
 - Always make sure that you wipe each product with clean water and thoroughly dry each product after cleaning. Some cleaning agents are corrosive in nature and may cause damage to the product if you use them improperly. If you do not properly rinse and dry the product, a corrosive residue may be left on the surface of the product that could cause premature degradation of critical components. Failure to follow these cleaning instructions may void your warranty.
-

Recommended disinfectants:

- Quaternaries (active ingredient - ammonium chloride) that contain less than 3% glycol ether
- Phenolic cleaners
- Chlorinated bleach solution (1 part bleach solution to 100 parts water)
- 70% isopropyl alcohol

1. Apply recommended disinfectant solution by spray or pre-soaked wipes. Do not soak the product.

Note - Make sure that you follow the disinfectant's instructions for appropriate contact time and rinsing requirements.

2. Wipe all the bassinet surfaces, with a dry soft, lint free cloth, to remove any excess liquid or disinfectant.
3. Allow the surfaces of the basket and bassinet to dry thoroughly.

Preventive maintenance

Remove product from service before you perform the preventive maintenance inspection. Check all items listed during annual preventive maintenance for all Stryker Medical products. You may need to perform preventive maintenance checks more often based on your level of product usage. Service only by qualified personnel.

Inspect the following items:

- _____ All fasteners are secure
- _____ Chart holder for damage
- _____ All four casters swivel
- _____ All four casters are free of wax and debris
- _____ All mechanisms operate
- _____ Two basket retention pins and tilt bar retainer are intact and secure
- _____ Retractable work surface is intact and secure
- _____ Basket tilt bar is intact
- _____ Drawers are intact and slide
- _____ Push handles
- _____ Height adjustment bars
- _____ Bassinet raises and lowers
- _____ Mattress for rips, tears, punctures, wear
- _____ Base cabinet for cracks or damage
- _____ Labels for legibility, proper adherence, and integrity

Product serial number:
Completed by:
Date:

stryker



Stryker Medical
3800 E. Centre Avenue
Portage, MI 49002
USA