



Secure II
MedSurg Bed
Model 3002

stryker[®]

Operations Manual



For parts or technical assistance call:
USA: 1-800-327-0770 (option 2)
Canada: 1-888-233-6888

Table of Contents

Introduction	5
Intended Use	5
Specifications	5
Mattress Specifications	6
Warning/Caution/Note Definition	6
Bed Illustration	7
Symbols	8
Safety Tips and Guidelines	9
Zoom Option	11
iBED Awareness Option	12
Setup Procedures	13
Zoom Option	14
Base Operation Guide	15
Brake Pedal Operation	15
Steer Pedal Operation (Beds without the Zoom Drive Wheel Option)	15
Litter Operation Guide	16
CPR Emergency Release	16
Foot Prop Usage	16
Fracture Frame Usage	16
Foley Bag Hooks Usage	16
Patient Restraint Strap Locations	16
Night Light Usage	17
Nurse Call Backup Battery (Optional Equipment)	17
Using the 110 Volt Outlet (Optional Equipment)	17
CPR Board Usage (Optional Equipment)	17
Operating I.V. Poles	18
Positioning Siderails	19
Siderail Control Panel Lights	19
Inside Siderail Function Guide	20
Outside Siderail Function Guide	21
Footboard Operation Guide	22
Foot Board Control Panel Guide	22
LED Display Panel Guide	23
Function Lockout System Usage	23
Chaperone Bed Exit (Optional Equipment)	24
Chaperone Bed Exit With Zone Control (Optional Equipment)	25
Chaperone Zone Settings	26
Scale System Operation Guide	27
Scale System Control Panel Guide (Optional)	27
Preparing The Bed For Patient Stay / Zeroing The Scale System	29
Activating The Scale System And Displaying Patient Weight	29
Adding Or Removing Items During A Patient's Stay	30
Converting The Patient's Weight	30
Displaying The Weight Log	31

Table of Contents

Scale System Operation Guide (Continued)	
Viewing Patient Weight In Gain / Loss Mode	32
Changing The Numerical Value Of Displayed Weight.	33
Optional Pendant Operation Guide	34
Zoom™ Option Operation Guide	35
Drive Wheel Operation.	35
Head End Control Panel Operation.	37
Battery Charging And Operation.	38
Optional <i>i</i> BED Awareness Operation Guide	39
Intended Use	39
Footboard Control Panel Buttons	39
Footboard Control Panel Functions.	40
LED Indicators: Footboard	42
LED Indicators: Dashboard.	43
Display Screens.	44
Power Up.	44
Status Screen	44
Message Screen	44
Main Menu Screen.	45
<i>i</i> BED Awareness Functionality	49
<i>i</i> BED Awareness Light Bar	49
<i>i</i> BED Awareness Side LED's	49
<i>i</i> BED Awareness Button.	49
<i>i</i> BED Awareness Monitoring and Alarms	50
Low Height	50
Brakes.	50
Siderails	50
Bed Exit.	51
Additional Alarm Conditions	51
<i>i</i> BED Awareness Locks	51
Fowler 30 ⁺ Lock button	51
Bed Motion Lock	52
Patient Control Locks.	52
Cleaning	53
Preventative Maintenance.	54
Warranty	55
Limited Warranty	55
To Obtain Parts and Service	55
Service Contract Coverage	55
Service Contract Programs	56
Return Authorization.	56
Damaged Merchandise	56
International Warranty Clause.	56

Introduction

Intended Use

This manual is designed to assist you with the operation of the Model 3002 Secure II Bed. Read it thoroughly before using the equipment.

Specifications

	Safe Working Load		500 lbs	227 kg	
	Note: Safe Working Load indicates the sum of the patient, mattress, and accessory weight.				
Scale System Capacity (optional equipment). Loads weighing up to			500 lbs	227 kg	
Scale System Accuracy (optional equipment)			± 2 pounds at 0° - ± 10° Trendelenburg for patients weighing 100 pounds or less ± 2% of the total patient weight at 0° - ± 10° Trendelenburg for patients weighing greater than 100 pounds		
Overall Length/Width	Standard Bed (Inside US and Canada)	Siderails Up	93" x 42.5"	236 cm x 108 cm	
		Siderails Down	93" x 40"	236 cm x 101.6 cm	
	Standard Bed (Outside US and Canada)	Siderails Up	93" x 42.5"	236 cm x 108 cm	
		Siderails Down	93" x 36"	236 cm x 92 cm	
	Short Bed (Inside US and Canada)	Siderails Up	85" x 42.5"	216 cm x 108 cm	
		Siderails Down	85" x 36"	216 cm x 92 cm	
	Zoom® Bed (Inside US and Canada)	Siderails Up	95" x 42.5"	241 cm x 108 cm	
		Siderails Down	95" x 40"	241 cm x 101.6 cm	
	Zoom® Short Bed (Inside US and Canada)	Siderails Up	87" x 42.5"	221 cm x 108 cm	
		Siderails Down	87" x 36"	221 cm x 92 cm	
	Patient Sleep Surface - Standard Bed			84" x 35"	213 cm x 89 cm
	Patient Sleep Surface - Short Beds			76" x 35"	193 cm x 89 cm
Bed Height to Top of Seat Litter - 6" Casters (Add 2" if bed has 8" casters)	Standard		16" to 30" ±0.5	41 cm to 76 cm	
	Beds with Zoom® Option		19.75" x 30"	50 cm x 76 cm	
	Short Beds w/Zoom® Option		20.5" x 30"	52 cm x 76 cm	
Litter Platform to Top of Siderail	Full Up	Head End Siderail	15.75"	40 cm	
	Full Up	Foot End Siderail	15.25"	38.7 cm	
	Outside US/Canada	Head End Siderail	15"	38.1 cm	
	Outside US/Canada	Foot End Siderail	14"	35.5 cm	
Space Between Siderails (Full Up)			9.75"	24.7 cm	
Outside the US and Canada			9.125" (8")	23.1 cm	
Knee Gatch Angle			0° to 40°		
Fowler Angle			0° to 60°		
Trendelenburg/Reverse Trendelenburg			-12° to +12° ± 1° -10° to +10° ± 1° - Beds with Zoom® Option -8° to +8° ± 1° - Short Beds		
Electrical Requirements - all electrical requirements meet UL 2601 specifications.			115 VAC, 60 Hz, 7.0 A Optional: 230 VAC, 50/60 Hz, 4.0 A		
Outlet Option			125 VAC, 60 Hz, 10.0 A (not available with Zoom® Option)		
¹ If the bed is equipped with the enhanced height option, the scale accuracy is as described above for litter angles from 0° to ±5° Trend.					

[Return To Table of Contents](#)

Introduction

Mattress Specifications

Thickness	6"	15.2 cm
Width	>= 35"	>= 88.9 cm
Length	>= 84"	>= 213.4 cm
ILD	80 lbs	36.3 kg

The above stated mattress specifications assist in ensuring the product conforms to HBSW and IEC specifications.

Stryker reserves the right to change specifications without notice.

Specifications listed are approximate and may vary slightly from unit to unit or by power supply fluctuations.

Warning/Caution/Note Definition

The words **Warning**, **Caution** and **Note** carry special meanings and should be carefully reviewed.

WARNING

Alerts the reader about a situation, which if not avoided, could result in death or serious injury. It may also describe potential serious adverse reactions and safety hazards.

CAUTION

Alerts the reader of a potentially hazardous situation, which if not avoided, may result in minor or moderate injury to the user or patient or damage to the equipment or other property. This includes special care necessary for the safe and effective use of the device and the care necessary to avoid damage to a device that may occur as a result of use or misuse.

Note

This provides special information to make maintenance easier or important instructions clearer.

Bed Illustration

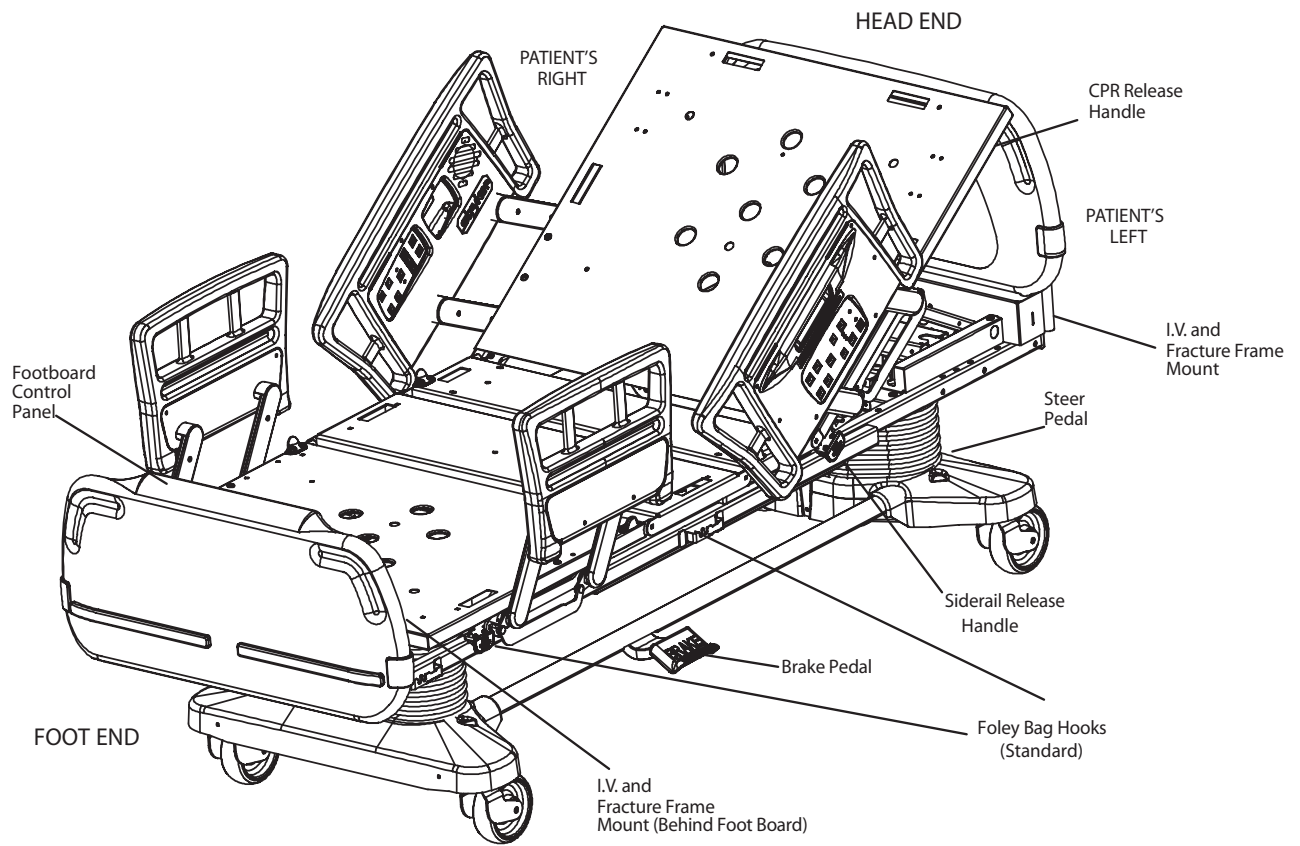

Symbols



Warning, Refer to Service/Maintenance Manual



Alternating Current



Type B Equipment: equipment providing a particular degree of protection against electric shock, particularly regarding allowable leakage current and reliability of the protective earth connection.

Class 1 Equipment: equipment in which protection against electric shock does not rely on BASIC INSULATION only, but which includes an additional safety precaution in that means are provided for the connection of the EQUIPMENT to the protective earth conductor in the fixed wiring of the installation in such a way that ACCESSIBLE METAL PARTS cannot become live in the event of a failure of the BASIC INSULATION.

Mode of Operation: Continuous

IPX4: Protection from liquid splash



Dangerous Voltage Symbol



Protective Earth Terminal



Potential Equalization Symbol



Medical Equipment Classified by Underwriters Laboratories Inc. with Respect to Electric Shock, Fire, Mechanical and Other Specified Hazards Only in Accordance with UL 60601-1, First Edition (2003) and CAN/CSA C22.2 No. 601.1-M90 with updates 1 and 2.



Safe Working Load Symbol



In accordance with European Directive 2002/96/EC on Waste Electrical and Electronic Equipment, this symbol indicates that the product must not be disposed of as unsorted municipal waste, but should be collected separately. Refer to your local distributor for return and/or collection systems available in your country.

Safety Tips and Guidelines

Safety Tips and Guidelines

Before operating the Secure Bed, it is important to read and understand all information in this manual. Carefully read and strictly follow the safety guidelines listed on this page. It is important that all users have been trained and educated on the inherent hazards associated with the usage of electric beds.

WARNING

- Danger: Explosion hazard. Do not use in the presence of flammable anesthetics. Always apply the caster brakes when a patient is getting on or off the bed.
- Always keep the caster brakes applied when a patient is on the bed (except during transport). After the brake pedal is applied, push on the bed to ensure the brakes are locked. Serious injury could result if the bed moves while a patient is getting in or out of bed.
- Ensure the brakes are completely released prior to attempting to move the unit. Attempting to move the unit with the brakes actuated could result in injury to the user and/or patient.
- Do not attempt to move the foot end of the bed laterally when the steer pedal is activated. When the steer pedal is activated, the steer caster at the foot end of the bed cannot swivel. Attempting to move the bed laterally when the steer pedal is activated may cause injury to the user.
- The Secure II Bed is not intended for use with patients less than two years of age. Serious injury can result if caution is not used when operating the unit. Operate the unit only when all persons are clear of the electrical and mechanical systems.
- To help reduce the number and severity of falls by patients, always leave the bed in the lowest position when the patient is unattended.
- When attaching equipment to the frame, ensure it will not impede normal frame operation. For example: hooks on hanging equipment must not actuate control buttons, equipment must not hide the nurse call button, etc. Use only a Stryker supplied interface cable. Use of any other cable may cause the bed to function improperly which may result in patient or user injury.
- The Secure II is equipped with a hospital grade plug for protection against shock hazard. It must be plugged directly into a properly grounded three prong receptacle. Grounding reliability can be achieved only when a hospital grade receptacle is used.
- When using the manual override shaft to manually actuate bed functions, always unplug the bed power cord from the wall socket to avoid injury in the event of a sudden return of power to the bed.
- When raising the siderails, listen for the "click" that indicates the siderail has locked in the up position. Pull firmly on the siderail to ensure it is locked into position. Siderails are not intended to be a patient restraint device. It is the responsibility of attending medical personnel to determine the degree of restraint and the siderail positioning to ensure a patient will remain safely in bed.
- The Bed Exit System is intended only to aid in the detection of a patient exiting the unit. It is NOT intended to replace patient monitoring protocol. The bed exit system signals when a patient is about to exit. Adding or subtracting objects from the frame after zeroing the weigh system may cause a reduction in the sensitivity of the bed exit system.
- Always unplug the bed power cord from the wall socket and push the battery power on/off switch to the "OFF" position before servicing or cleaning the bed. When working under the bed with the bed in the high position, always place blocks under the litter frame and apply the brakes to prevent injury in case the Bed Down switch is accidentally pressed.
- The CPR emergency release on the Short Bed frame may require assistance to lower the back when the back is in the highest position. Attempting to lower the back in this position without assistance may result in injury to the operator.
- Only use equipment with the following electrical specs: 110 VAC; 10A; 60Hz. Maximum total load drawn by equipment used in this receptacle outlet must not exceed 10A. The total system chassis risk current should not exceed 300uA. Grounding continuity should be checked periodically.

Safety Tips and Guidelines

Safety Tips and Guidelines (Continued)

WARNING (CONTINUED)

- To avoid risk of electrical shock, unplug all power cords before opening the service compartment, junction box or receptacle.
- Do not use the optional 110V outlet for life sustaining equipment.
- To avoid pinching your fingers, place the I.V. pole in the upright position before using the drive handle.
- When using any mattress and/or mattress overlay that increases the overall height greater than 6" extra caution and/or operator supervision is required to help reduce the likelihood of a patient fall occurring.

To avoid possible injury and to assure proper operation when using a powered mattress replacement system such as XPRT:

- Confirm proper scale system operation following mattress installation. For best results, secure the therapy mattress power cord to prevent damage to the cord or interference with the bed frame and the scale system.
- Do not zero bed scales or weigh patient with Percussion, Vibration, Rotation or Turn Assist active. Patient motion and position resulting from the dynamic therapy mattress may adversely affect scale system performance.
- Do not initialize ("arm") bed exit with Percussion, Vibration, Rotation or Turn Assist active. The patient motion and position resulting from the dynamic therapy mattress may adversely affect bed exit system performance.
- When using an XPRT Therapy Mattress extra caution and/or operator supervision is required to help reduce the likelihood of a patient fall occurring.

CAUTION

- When large spills occur in the area of the circuit boards, 110 volt cables and motors, immediately unplug the bed power cord from the wall socket. Remove the patient from the bed and clean up the fluid. Have maintenance completely check the bed. Fluids can affect the operational capabilities of any electrical product. DO NOT put the bed back into service until it is completely dry and has been thoroughly tested for safe operation.
- Preventative maintenance should be performed at a minimum of annually to ensure all bed features are functioning properly. Close attention should be given to safety features including, but not limited to safety side latching mechanisms, frayed electrical cords and components, all electrical controls return to off or neutral position when released, caster braking systems, no controls or cabling entangled in bed mechanisms, leakage current 300 microamps maximum, scale and bed exit systems calibrated properly.
- Because individual beds may have different options, foot boards should not be moved from one bed to another. Mixing foot boards could result in unpredictable bed operation.
- The lockout buttons on the foot board lock the Fowler, Gatch and Bed Up/Down functions and prevent motion of the bed. It is the responsibility of attending medical personnel to determine whether these functions should be locked and to use the buttons accordingly.
- The weight of the I.V. bags should not exceed 40 pounds.
- Scale function may be affected by siderail/caster interference. With the litter fully lowered or lowered in Reverse Trendelenburg, the siderails tucked under the litter in the storage position and the casters turned, there is the potential for interference between the siderail and the caster. Raise the siderails when lowering the litter to the full down position to prevent the interference from causing the scale system to weigh inaccurately.
- When attaching equipment to the frame, ensure it will not impede normal operation. For example: hooks on hanging equipment must not actuate control buttons, equipment must not hide the nurse call button, etc..

Safety Tips and Guidelines

Safety Tips and Guidelines (Continued)

CAUTION

- The use of a mattress overlay may reduce the effectiveness of the siderail.
- I.V. Poles should not be used as a bed push/pull device. The cleanliness and integrity of both ground chains must be maintained to minimize static build up and discharge.
- Do not add or remove weight when the bed exit system is armed.

Zoom Option

In addition to the previous warnings and cautions, all of the following warnings and cautions apply to units equipped with the Zoom option.

WARNING

- The 3002 Patient Transport Frame is intended for use by trained hospital personnel only. Failure to properly train personnel could result in injury.
- USE CAUTION while maneuvering the unit with the drive wheel activated. Always ensure there are no obstacles near the unit while the drive wheel is activated. Injury to the patient, user or bystanders or damage to the frame or surrounding equipment could occur if the unit collides with an obstacle.
- Use caution when transporting the unit down halls, through doors, in and out of elevators, etc. Damage to the siderails or other parts of the unit could occur if the unit comes in contact with walls or door frames.
- Put the drive wheel in the neutral position and release the brakes before pushing the unit manually. Do not attempt to push the unit manually with the drive wheel engaged. The unit will be difficult to push and injury could result.
- If unanticipated motion occurs, unplug the power cord from the wall socket, push the battery power on/off switch to the "OFF" position (the LED will not be illuminated) and actuate the drive wheel pedal to the neutral position.
- The power save mode is activated after one hour on battery power with no motion release switch activation. Functions including Bed Exit, Scale and Motion will cease to operate when the unit enters the power save mode. Injury to the patient could occur if proper patient monitoring protocol is not observed.
- Always unplug the power cord and push the battery power on/off switch to the "OFF" position before service or cleaning. When working under the frame, always place blocks under the litter frame to prevent injury in case the Bed Down switch is accidentally activated.
- Due to the weight the battery adds to the bed (approximately 50 pounds), additional force is required to move the bed. Caution should be used when transporting this bed. Additional assistance should be used when necessary. Failure to use caution while transporting this bed may result in injury to the user.
- Battery posts, terminals and related accessories contain lead and lead compounds, chemicals known to the State of California to cause cancer and birth defects or other reproductive harm. Wash hands after handling.
- Do not modify the 3002 Patient Transport Frame. Modifying the unit can cause unpredictable operation resulting in injury to the patient or operator. Modifying the unit will also void its warranty.

CAUTION

- To avoid damage while transporting the bed, verify the I.V. pole is at a low enough height to allow it to safely pass through door openings and under light fixtures.
- The battery tray assembly weighs 50 pounds. Take care when removing the two hex head screws securing it to the base frame or personal injury could result.

[Return To Table of Contents](#)

Safety Tips and Guidelines

iBED Awareness Option

In addition to the previous warnings and cautions, all of the following warnings and cautions apply to units equipped with the *i*BED Awareness option.

WARNING

- The optional *i*BED Awareness system only indicates the siderail position, it does NOT indicate if the siderail is locked. It is the caregiver's responsibility to ensure that the siderails are locked after every move and also before leaving a patient in the room.
 - The optional *i*BED Awareness system indicator lights are only an aid to the caregiver but in no way replace the caregiver's responsibility of checking on patients. Caregivers should not rely on the lights to perform their duties.
 - Before arming the optional *i*BED Awareness system, the nurse must physically verify that siderails are locked.
-

CAUTION

- If the optional *i*BED Awareness system is being used; ensure the bed is in the desirable state (*i*BED Awareness ON and with the light Green) before leaving the room.
- If the optional *i*BED Awareness system is being used and the *i*BED Awareness is alerting, do not turn off *i*BED Awareness as the display information to troubleshoot the bed will get lost.
- If the optional *i*BED Awareness system is being used; use of accessories that cover the alert light are not recommended.

Setup Procedures

Setup Procedures

It is important that the Secure II Bed is working properly before it is put into service. The following list will help ensure that each part of the bed is tested.

- Plug the bed into a properly grounded, hospital grade wall receptacle and ensure the "Power" LED light at the foot end of the bed comes on.

WARNING

The Secure II is equipped with a hospital grade plug for protection against shock hazard. It must be plugged directly into a properly grounded three prong receptacle. Grounding reliability can be achieved only when a hospital grade receptacle is used.

- Plug the optional interface cable into the 37 pin connector under the litter frame at the head end of the bed, and into the "Patient Station", "Head Wall", "Docking Station", or equivalent (whichever applies). Test the interface cable to verify it is functioning properly.

WARNING

Use only a Stryker supplied interface cable. Use of any other cable may cause the bed to function improperly which may result in patient or user injury.

- Ensure the siderails raise, lower and store smoothly and lock in the up position and in the intermediate position when lowered ([page 19](#)).
- Ensure that all four casters lock when the brake pedal is engaged ([page 15](#)).
- Raise the back up to approximately 60°. Squeeze the CPR release handle and ensure the back will drop with minimal effort.

NOTE

Ensure that the "Brake Not Set" LED located on the outside of the head end siderails and the foot board control panel (Non-LBS option only) or "Brake" LED located on the outside of the footboard control panel (LBS option only) come on when the brakes are disengaged.

- Run through each function on the foot board control panel to ensure that each function is working properly ([page 22](#)).
- Run through each function on both head end siderails to ensure that each is working properly ([page 19](#)).
- Activate the motion stop system to ensure it is functioning properly; press and hold down the BED DOWN key. As the bed lowers, lift up on the motion interrupt pan and ensure the downward motion stops. Release the pan and allow the downward motion to continue.

NOTE

The bed's upward motion or other functions are not disrupted by the motion stop system.

- If the bed is equipped with the Nurse Call option, verify it is functioning properly prior to patient use.

Setup Procedures

Zoom Option

If your bed is equipped with the Zoom drive wheel option, run through the setup procedures on [page 13](#) and continue with the procedures listed below.

- Plug the power cord into a properly grounded, hospital grade wall receptacle. The 12 volt batteries that provide power to the drive wheel and backup power to the unit functions will charge whenever the power cord is plugged into the wall socket. The batteries require approximately 10 hours of charging time before the bed is put into service.
- Unplug the power cord from the wall socket. Push the battery power switch located on the lower left corner of the head end to the “ON” position. Again, verify each function on the foot board and siderails is operating properly.
- With the battery power switch in the “ON” position and the brakes engaged, ensure the “Release Brakes”LED on the head end control panel is illuminated.
- With the battery power switch in the “ON” position and the drive wheel in the neutral position (not touching the floor), ensure the “Engage Drive Wheel” LED on the head end control panel is illuminated.
- Run through the operation of the drive wheel ([see page 35](#)) to ensure it is operating properly.

If any problems are found during bed setup, contact Stryker Customer Service at (800) 327–0770.

Base Operation Guide

Brake Pedal Operation

WARNING

Always apply the caster brakes when a patient is getting on or off the bed. Push on the bed to ensure the brakes are securely locked. Always engage the brakes unless the bed is being moved. Injury could result if the bed moves while a patient is getting on or off the bed.

To activate the brakes, push down once on one of the pedals located at the midpoint of the bed on both sides (identified by the label at right). The pedal will remain in the lowered position, indicating the brakes are engaged. To disengage the brakes, push down once and the pedal will return to the upper position.

BRAKE
PRESS TO SET OR RELEASE

NOTE

There are LED lights on the outside of the head end siderails and on the foot end control panel that will blink when the brakes are not engaged only if the bed is plugged into a wall socket ([see pages 21 & 23](#)). The brakes will still operate properly when the bed is not plugged in.

Steer Pedal Operation (Beds without the Zoom Drive Wheel Option)

When the bed is moved, the steer caster helps guide the bed along a straight line and helps the bed pivot around corners.

To activate the steer caster, move the pedal located at the head end of the bed to your left as shown on the label.

ON STEER OFF

NOTE

For proper "tracking" of the steer caster, push the bed approximately 10 feet to allow the wheels to face the direction of travel before engaging the steer pedal. If this is not done, proper "tracking" will not occur and the bed will be difficult to steer.

WARNING

Do not attempt to move the foot end of the bed laterally when the steer pedal is activated. When the steer pedal is activated, the steer caster at the foot end of the bed cannot swivel. Attempting to move the bed laterally when the steer pedal is activated may cause injury to the user.

[Return To Table of Contents](#)

Litter Operation Guide

CPR Emergency Release

When quick access to the patient is needed, and the Fowler is raised, squeeze one of the two red release handles and the Fowler can be quickly guided down to a flat position.

NOTE

The handle can be released at any time to stop the Fowler from lowering.

Foot Prop Usage

To prop the foot end of the Knee Gatch up, grasp the end of the Knee Gatch and lift upward, allowing the foot prop (A) to engage at the desired height. To release the prop, swing the prop (A) toward the head end of the bed to disengage the hinge and lower the foot end.

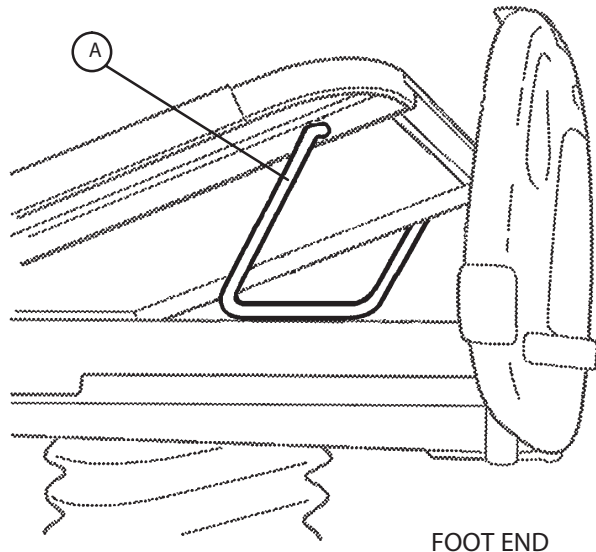

WARNING

To avoid injury while cleaning or servicing under the foot section, secure the foot section with string or bungee cords or hold it up out of the way.

Fracture Frame Usage

A standard fracture frame can be mounted on the bed using the IV sockets located on all four corners of the bed.

I.V. poles can be used in conjunction with a fracture frame if the I.V. pole adaptor sockets are purchased.

WARNING

Use only retractable traction or fracture frames. Failure to use a retractable frame may result in injury to the patient and/or damage to the equipment.

Foley Bag Hooks Usage

The standard Foley bag hooks are found at two locations on both sides of the frame; under the frame below the seat section and at the extreme foot end of the frame. The optional isolated Foley bag hooks are located at the foot end of the bed on top of the lift header. The patient weight reading on the scale system will not be affected when the optional isolated Foley bag hooks are used.

Patient Restraint Strap Locations

The bed has 12 locations for installing patient restraint straps on the litter top, 6 on each side of the bed.

WARNING

Improperly adjusted restraint straps can cause serious injury to a patient. The clinician must use her/his judgement to determine proper use of restraint straps and restraint strap locations. Clean Velcro AFTER EACH USE. Saturate Velcro with disinfectant and allow disinfectant to evaporate. (Appropriate disinfectant for nylon Velcro should be determined by the hospital.)

Litter Operation Guide

Night Light Usage

The bed is equipped with two night lights to illuminate the floor area around the bed. There is a switch under the litter thigh section on the patient's left side that turns both lights on and off.

NOTE

The night lights have a sensor so the lights will turn off, even when the switch is on, if the light in the room is bright enough so a night light is not necessary.

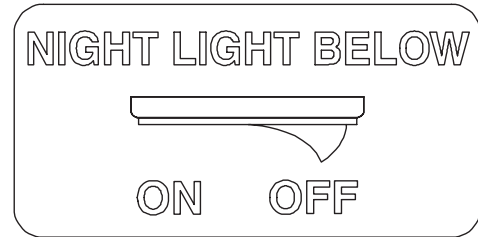

Nurse Call Backup Battery (Optional Equipment)

- To prevent a low battery condition when the bed is not plugged in, position the cord out switch at the head end of the bed to the off position. The switch is identified by the label shown below. If the switch is not positioned as shown below and the bed power cord and pendant cord are unplugged, the life of the backup battery will be significantly reduced.
- If the power light (located on the foot board) is flashing, the Nurse Call battery needs to be replaced. The battery is located on the patient's left side at the head end of the bed. No tools are required to replace the battery. Unplug the bed power cord from the wall socket and replace the battery.

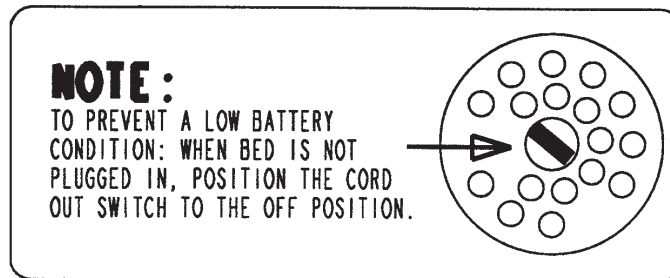

Using the 110 Volt Outlet (Optional Equipment)

- The 110V outlet has its own power cord that must be plugged into a properly grounded three prong wall receptacle different from the wall receptacle the bed power cord is plugged into.
- If the equipment plugged into the bed outlet is not receiving power, check the circuit breakers located on the litter frame under the head section. Reset, if necessary.

WARNING

- Only use equipment with the following electrical specs: 110 VAC; 10A; 60Hz. Maximum total load drawn by equipment used in this receptacle outlet must not exceed 10A. The total system chassis risk current should not exceed 300uA. Grounding continuity should be checked periodically.
- To avoid risk of electrical shock, unplug **all** power cords before opening the service compartment, junction box or receptacle.
- Do not use the optional 110V outlet for life sustaining equipment.

CPR Board Usage (Optional Equipment)

If the bed is equipped with the optional CPR board, it is stored on the bed's head board. To remove it, pull it away from the head board and lift it out of storage position. If the CPR board option was not purchased, the head board can also be removed and used as an emergency CPR board.

Litter Operation Guide

Operating I.V. Poles

To use the 2-Stage Permanently Attached I.V. pole:

Note

The 2-stage permanently attached I.V. pole is an option and may have been installed at either the head, foot or both ends. The choice was made at the time the unit was purchased.

1. Lift and pivot the pole from the storage position and push down until it rests in the receptacle.
2. To raise the height of the pole, pull up on the telescoping portion (A) until it locks into place at its fully raised position.
3. Rotate the I.V. hangers (B) to desired position and hang I.V. bags.
4. To lower the I.V. pole turn the latch (C) clockwise until section (A) lowers.

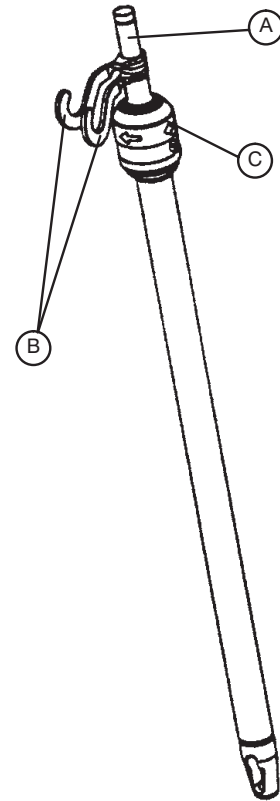

CAUTION

The weight of the I.V. bags should not exceed 40 pounds.

WARNING

To avoid pinching your fingers, place the I.V. pole in the upright position before using the drive handle.

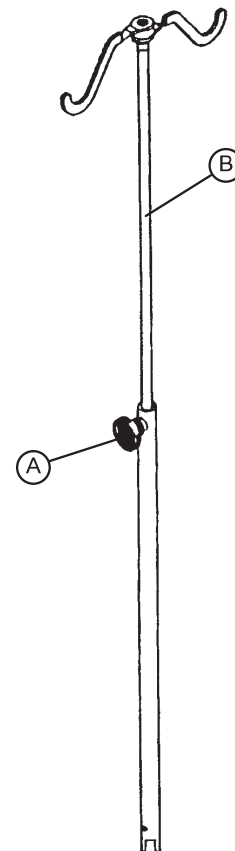

To use the “Removable” IV pole:

1. Install the pole at any of the four receptacles on the bed top (located on all four corners of the frame).
2. To raise the height of the pole, turn knob (A) counterclockwise and pull up on the telescoping portion (B) of the pole and raise it to the desired height.
3. Turn knob (A) clockwise to tighten the telescoping portion in place.

CAUTION

The weight of the I.V. bags should not exceed 40 pounds.

Litter Operation Guide

Positioning Siderails

NOTE

- The siderails can be locked at two heights (intermediate & full up). The foot end siderails on a Short Bed do not have an intermediate position.
- The siderails can slide to the side of the bed when not in use. To remove the rail from the tucked position, grasp the top of the rail and pull outward.
- To engage the head end siderail, grasp the rail and swing it upward to full height. When the siderail is being raised, it does not lock in the intermediate position. To lower the siderail, push in the yellow release handle (A) and rotate the siderail until it locks in the intermediate position. To lower the siderail fully, push in the yellow release handle (A) again and rotate the siderail until it is completely lowered.
- To engage the foot end siderail, the same procedure is required as for the head end siderail, however, the siderail swings toward the foot end of the bed.

WARNING

Be sure the siderail is locked securely into position. Siderails are not intended to keep patients from exiting the bed. They are designed to keep a patient from inadvertently rolling off the bed. Proper restraint methods should be utilized to ensure the patient remains in the bed. The siderails are not intended to be used as a push device.

To disengage the rail, push in the yellow release handle (A) and swing the rail down to the desired height. Store the siderails slid.

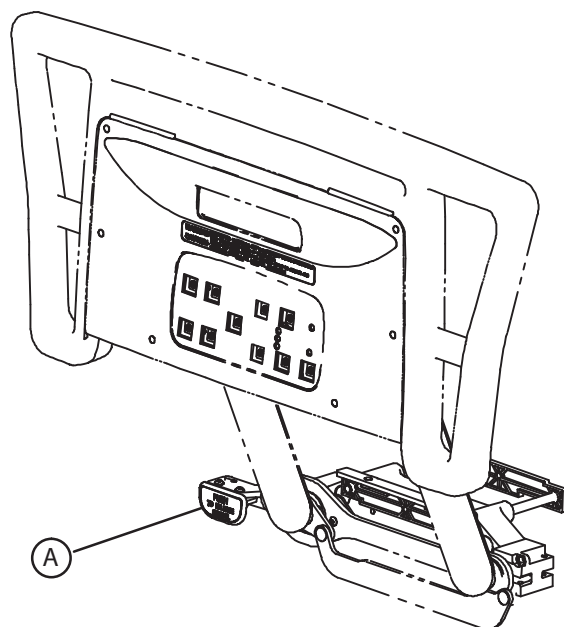

Siderail Control Panel Lights

The bed is equipped with lights to illuminate the head end siderail control panel and the red nurse call switches. Both can be activated at the foot board control panel. Three settings are available for the control panel lights: low, medium and high intensity. When all lights are off, push the siderail control light button at the foot board once to turn on both the control lights and the nurse call light at the siderail. Push again to change from low to medium setting, and a third time to change to the high setting. The nurse call light intensity is not affected. Pushing the button a fourth time will turn off the siderail control panel lights and pushing it a fifth time will turn off the red nurse call light as well ([see control panel guide page 22](#)).

NOTE

The purpose of the red nurse call light on the siderails is to ensure the patient immediately knows which button to push to contact the nurse station. Turning the red light off may compromise this ability, especially in a darkened room.

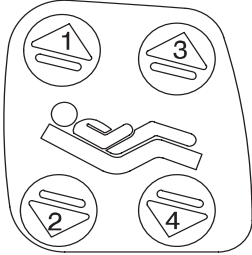
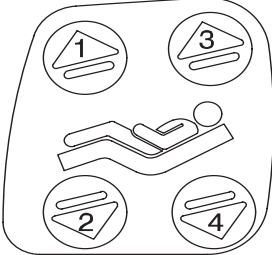
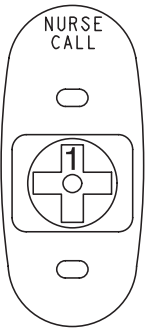
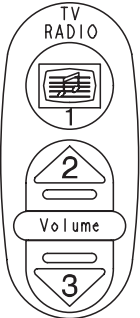
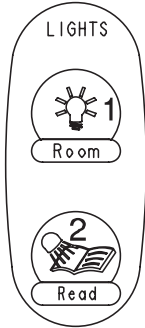
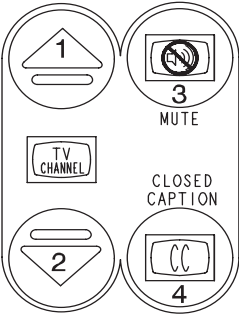

Siderail Operation Guide

Inside Siderail Function Guide

Function	Display
<p>Patient's Left Rail</p> <ol style="list-style-type: none"> 1. Push to raise Fowler. 2. Push to lower Fowler. 3. Push to raise Knee Gatch. 4. Push to lower Knee Gatch. 	<p>Patient's Right Rail</p> <ol style="list-style-type: none"> 1. Push to raise Knee Gatch. 2. Push to lower Knee Gatch. 3. Push to raise Fowler. 4. Push to lower Fowler. 
<p>Optional Nurse Call</p> <ol style="list-style-type: none"> 1. Push to activate Nurse Call. <p>Note Yellow LED will light when button is pushed. Red LED will light with Nurse Station acknowledgment.</p> <p><i>This panel is optional equipment.</i></p> 	<p>Optional TV / Radio</p> <ol style="list-style-type: none"> 1. Push to turn TV or radio on and to select a channel. 2. Push to increase volume. 3. Push to decrease volume. <p><i>This panel is optional equipment.</i></p> 
<p>Optional Lights</p> <ol style="list-style-type: none"> 1. Push to turn the room light on. 2. Push to turn the bed overhead light on. <p><i>This panel is optional equipment.</i></p> 	<p>Optional SMTV Channel/Volume</p> <ol style="list-style-type: none"> 1. Push to change TV channel up. 2. Push to change TV channel down. 3. Push to mute TV volume. Push again to turn the sound back on. 4. Push to display the closed captioning. Push again to turn off the closed captioning. <p><i>This panel is optional equipment.</i></p> 

Siderail Operation Guide

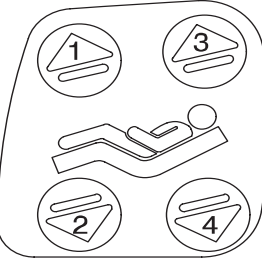
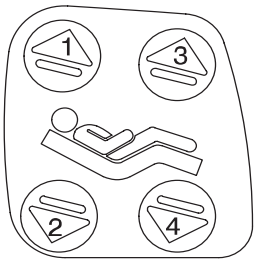
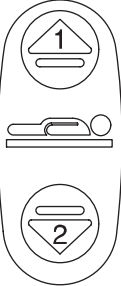
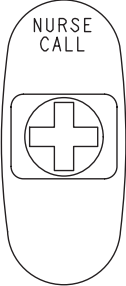
Outside Siderail Function Guide

Function	Display
<p>Optional Patient's Left Rail</p>  <ol style="list-style-type: none"> 1. Push to raise Fowler. 2. Push to lower Fowler. 3. Push to raise Knee Gatch. 4. Push to lower Knee Gatch. 	<p>Optional Patient's Right Rail</p>  <ol style="list-style-type: none"> 1. Push to raise Knee Gatch. 2. Push to lower Knee Gatch. 3. Push to raise Fowler. 4. Push to lower Fowler.
<p>Raise/Lower Bed</p>  <ol style="list-style-type: none"> 1. Push to raise bed height. 2. Push to lower bed height. 	<p>Optional Nurse Call</p>  <ol style="list-style-type: none"> 1. Push to activate Nurse Call. <p><i>This panel is optional equipment.</i></p>
<p>Brake Not Set LED</p>  <ol style="list-style-type: none"> 1. LED will blink when the brakes are not set. 	<p>Optional Cardiac Chair</p>  <ol style="list-style-type: none"> 1. Push to activate the Cardiac Chair function. 2. The Knee will raise. 3. The back will raise or lower to approximately 52° 4. The bed will tilt to approximately -12° reverse Trendelenburg (foot end down). 5. For Short Beds it will tilt approximately -10°. 6. Release the button to stop bed movement; hold the button until movement stops to complete the function. <p><i>This panel is optional equipment.</i></p>

Footboard Operation Guide

(Applies to Non-*i*BED Awareness Option Beds)

Foot Board Control Panel Guide

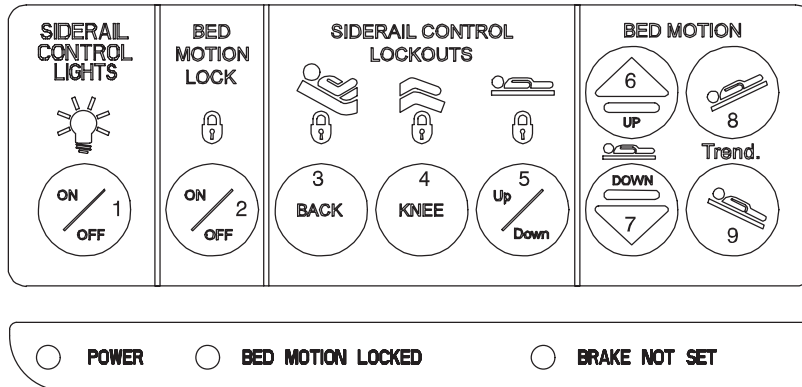

1. Push repeatedly for low, medium and high settings for the siderail control panel lights. Pushing a fourth and fifth time will turn off the siderail lights and the red nurse call light respectively (see page 19).

NOTE

The intent of the red nurse call light on the siderails is to ensure the patient immediately knows which button to push to contact the nurse station. Turning the red light off may compromise this ability, especially in a darkened room.

2. Push to lock out all bed motions. The MOTION lock icon and the “BED MOTION LOCKED” LED will light. Push again to unlock.
3. Push to lock out Back Rest controls at both siderails. The HEAD lock icon will light. Push again to unlock.
4. Push to lock out Knee Gatch controls at both siderails. The KNEE lock icon will light. Push again to unlock.
5. Push to lock out bed height movement at both siderails. The UP/DOWN lock icon will light. Push again to unlock.
6. Push to raise bed height.
7. Push to lower bed height.
8. Push to lower head end/raise foot end of bed (Trendelenburg position).
9. Push to lower foot end/raise head end of bed (Reverse Trendelenburg position).

CAUTION

Individual beds may have different options therefore, foot boards should not be moved from one bed to another. Mixing foot boards could result in unpredictable bed operation.

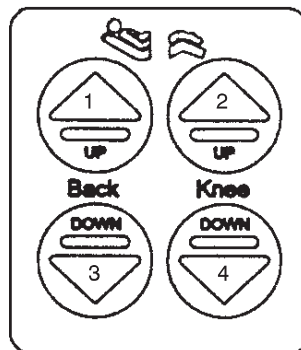

1. Push to raise Fowler.
2. Push to raise Knee Gatch.
3. Push to lower Fowler.
4. Push to lower Knee Gatch.
 - This panel is optional equipment.

Footboard Operation Guide

(Applies to Non-iBED Awareness Option Beds)

LED Display Panel Guide

The LED Display Panel is located at the foot end of the bed, under the Control Panel.



"POWER" – will light when the bed is plugged into the wall receptacle. Will blink if the 9V Nurse Call battery needs to be replaced.

"BED MOTION LOCKED" – will light when the Bed Motion Lock has been activated.

"BRAKE NOT SET" – will blink when the brakes have not been set.

"BED EXIT ON" – will light when the Bed Exit function has been activated (optional equipment).

Function Lockout System Usage

1. To lock out the bed movement functions on the siderails and prevent the patient from changing the positioning of the bed, push the "HEAD", "KNEE" and/or "UP/DOWN" switches in the "Siderail Control Lockouts" module on the foot board control panel.

NOTE

The foot board controls for these motions are not affected by the lockout switches.

The "padlock" symbol on the control panel will be lighted when that function is locked out.

2. To lock out the entire bed motion for all switches on the bed (siderails and foot board), push the "ON/OFF" switch in the "Bed Motion Lock" module on the foot board control panel.

CAUTION

The lockout buttons on the foot board lock the Fowler, Gatch and Bed Up/Down functions and prevent motion of the bed. It is the responsibility of attending medical personnel to determine whether these functions should be locked and to use the buttons accordingly.

Footboard Operation Guide

(Applies to Non-*i*BED Awareness Option Beds)

Chaperone Bed Exit (Optional Equipment)

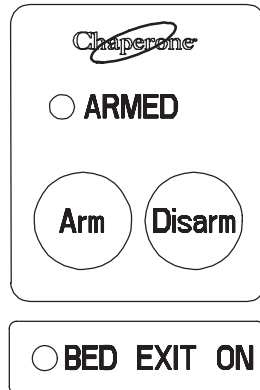

For beds with a scale system:

NOTE

If the weigh system is in use, it will switch to "off" when the "ARM" key is pressed.

1. Before putting the patient on the bed, the weigh system must be zeroed for the Bed Exit System to function properly (see page 28 for instructions on zeroing the weigh system).
2. Put the patient on the bed and push the "ARM" key to activate the Bed Exit function. The "ARMED" light will come on .
3. To deactivate Bed Exit, push the "DISARM" key. The "ARMED" and "BED EXIT ON" lights will turn off.

For beds without a scale system:

1. Before putting the patient on the bed, press and hold the "ARM" and the "DISARM" keys together until the "ARMED" light begins to flash.
2. Release the "ARM" and the "DISARM" keys and do not touch the bed until the "ARMED" light stops flashing.
3. Put the patient on the bed and push the "ARM" key to activate the Bed Exit function. The "ARMED" light will come on.
4. To deactivate Bed Exit, push "DISARM". The "ARMED" and "BED EXIT ON" lights will turn off.

WARNING

The Bed Exit System is intended only to aid in the detection of a patient exiting the bed. It is NOT intended to replace patient monitoring protocol. It signals when a patient is about to exit. Adding or subtracting objects from the bed after arming the bed exit system may cause a reduction in the sensitivity of the bed exit system. To avoid possible injury and to assure proper operation when using a powered mattress replacement system such as XPRT, do not initialize ("arm") bed exit with Percussion, Vibration, Rotation or Turn Assist active. The patient motion and position resulting from a dynamic therapy mattress may adversely affect bed exit system performance.

Footboard Operation Guide

(Applies to Non-iBED Awareness Option Beds)

Chaperone Bed Exit With Zone Control (Optional Equipment)

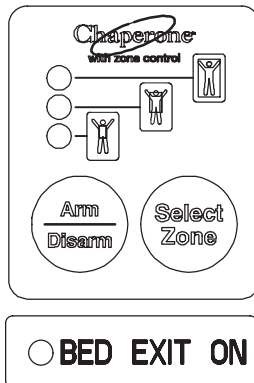

For Beds with a Scale System:

NOTE

If the weigh system is in use, it will switch to "off" when Bed Exit is armed.

1. Before putting the patient on the bed, the weigh system must be zeroed for the Bed Exit System to function properly (see page 28 for instructions on zeroing the weigh system).
2. Put the patient on the bed and push and release the "ARM/DISARM" key (top light will come on).
3. The Bed Exit system with Zone Control will automatically select the first zone. To change the zone, push and hold the "SELECT ZONE" key until the light indicating the desired zone comes on.
4. To deactivate Bed Exit, push the "ARM/DISARM" key. The selected zone light and "BED EXIT ON" lights will turn off.

For Beds without a Scale System:

1. Before putting the patient on the bed, press and hold the "ARM/DISARM" and the "SELECT ZONE" keys together for 5 seconds. The top light will begin to flash.
2. Release the "ARM/DISARM" and the "SELECT ZONE" keys and do not touch the bed until the top light stops flashing.
3. Put the patient on the bed and push and release the "ARM/DISARM" key (top light will come on).
4. The Bed Exit system with Zone Control will automatically select the first zone. To change the zone, push and hold the "SELECT ZONE" key until the light indicating the desired zone comes on.
5. To deactivate Bed Exit, push the "ARM/DISARM" key. The selected zone light and "BED EXIT ON" light will turn off.

WARNING

To avoid possible injury and to assure proper operation when using a powered mattress replacement system such as XPRT, do not initialize ("arm") bed exit with Percussion, Vibration, Rotation or Turn Assist active. The patient motion and position resulting from a dynamic therapy mattress may adversely affect bed exit system performance.

[Return To Table of Contents](#)

Footboard Operation Guide

(Applies to Non-*i*BED Awareness Option Beds)

Chaperone Bed Exit With Zone Control (Optional Equipment) (Continued)

Chaperone Zone Settings

The first zone (top indicator light) is the traditional Bed Exit zone. The patient can move around the bed freely but cannot fully exit the bed or the alarm will sound.

The second zone (middle indicator light) is more restrictive than the first zone. When the zone is selected, the bed measures the location of the patient's center of gravity. If the patient's center of gravity moves from the original location more than 6.5 inches to either side or 13 inches toward the head or foot, an alarm will sound.

The third zone (bottom indicator light) is the most restrictive zone. When the zone is selected, the bed measures the location of the patient's center of gravity. If the patient's center of gravity moves from the original location more than 1 inch to either side or 1 inch toward the head or foot, an alarm will sound.

NOTE

All zone dimensions are $\pm .5$ inches.

Scale System Operation Guide

(Applies to Non-iBED Awareness Option Beds)

Scale System Control Panel Guide (Optional)

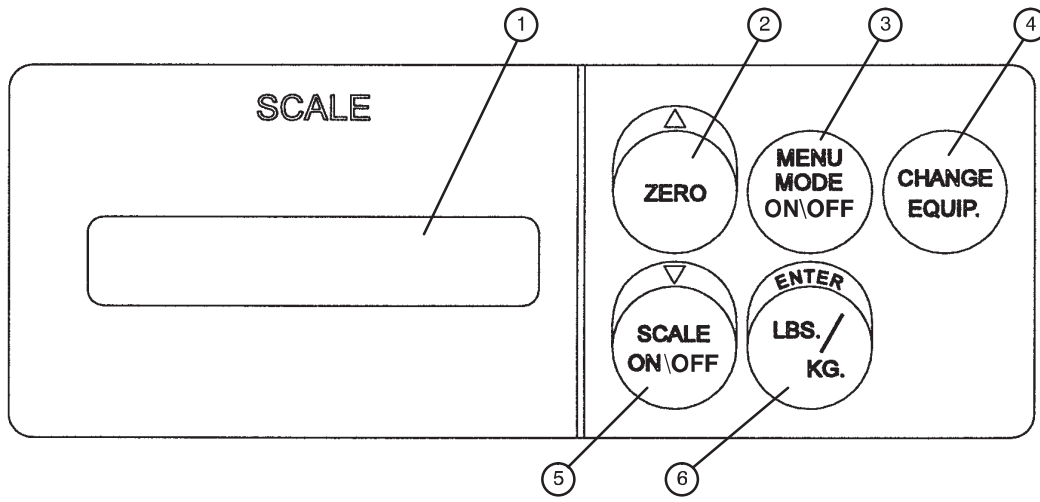

NOTE

This panel is optional equipment.

1. LCD – displays patient weight. Trendelenburg angle is displayed when the scale is not active.
2. Press to zero bed (see page 29). Also press to scroll while Menu Mode is active.
3. Press to enter and exit the Menu Mode.
4. Press when adding or removing equipment to the bed (see page 30).
5. Press to turn scale system on and off. Also press to scroll while Menu Mode is active.
6. Press to change weight from pounds to kilograms or back (see page 30). Also press while using the Menu Mode.

NOTE

If weight is displayed, SCALE ON/OFF must be pressed to turn off the scale before the Trend or Fowler angle will display.

CAUTION

Scale function may be affected by siderail/caster interference. With the litter fully lowered or lowered in Reverse Trendelenburg, the siderails tucked under the litter in the storage position and the casters turned, there is the potential for interference between the siderail and the caster. Raise the siderails when lowering the litter to the full down position to prevent the interference from causing the scale system to weigh inaccurately.

WARNING

To avoid possible injury and to assure proper operation when using a powered mattress replacement system such as XPRT:

- Confirm proper scale system operation following mattress installation. For best results, secure the mattress power cord to prevent damage to the cord and interference with the bed frame and the scale system.
- Do not zero bed scales or weigh patient with Percussion, Vibration, Rotation or Turn Assist active. Patient motion and position resulting from the dynamic therapy mattress may adversely affect scale system performance.

[Return To Table of Contents](#)

Scale System Operation Guide

(Applies to Non-*i*BED Awareness Option Beds)

SCALE SYSTEM CONTROL PANEL GUIDE (CONTINUED)

For more detailed operating instructions, see the following Operation Sections:

1. Preparing The Bed For Patient Stay/Zeroing the Bed - [page 29](#)
2. Activating the Scale System and Displaying Patient Weight - [page 29](#)
3. Adding or Removing Items During a Patient's Stay - [page 30](#)
4. Converting the Patient's Weight - [page 30](#)
5. Displaying the Weight Log - [page 31](#)
6. Viewing Patient Weight In Gain/Loss Mode - [page 32](#)
7. Changing the Numerical Value Of Displayed Weight - [page 33](#)

Scale System Operation Guide

(Applies to Non-iBED Awareness Option Beds)

Preparing The Bed For Patient Stay / Zeroing The Scale System

NOTE

Do not zero the bed while a patient is in bed. If this should occur, remove the patient and zero the bed again. If Bed Exit is armed, it must be disarmed before the scales can be zeroed.

Prepare the bed for the patient's stay by adding/removing linens, pillows, etc.

- Press and release  The scale monitor will read:
“LET GO FOR SCALE”
“WEIGHING”
“XXX.X LB”

- Press and hold  The scale monitor will read:
“HOLD TO ZERO WT.”
“RELEASE TO ZERO”

- Release  The scale monitor will now read:
“DO NOT TOUCH BED”
“0.0 LB”

The bed is now ready for the patient.

NOTE

If there is a problem with a load cell or another component of the scale system, the system will try to zero for 30 seconds, and the scale monitor will read:

“UNABLE TO ZERO”
“TRY AGAIN”

If the problem continues, after 3 attempts at zeroing, the scale system will lock and the scale monitor will read:

“Scale Sys. Error”
“Call for service”

Unplug the bed power cord from the wall socket and plug it back in. If the problem continues, call a service technician.

Activating The Scale System And Displaying Patient Weight

- Press and release  The scale monitor will read:
“LET GO FOR SCALE”
“WEIGHING”
“XXX.X LB”

[Return To Table of Contents](#)

Scale System Operation Guide

(Applies to Non-*i*BED Awareness Option Beds)

Adding Or Removing Items During A Patient's Stay

- If it is necessary to add or remove items (monitors, pumps, etc.) during the patient's stay, press and release



to activate the scale system. After the scale monitor reads: "XXX.X LB", press and hold



The scale monitor will read: "HOLD TO START"
"RELEASE TO START"

- Release



The scale monitor will read: "DO NOT TOUCH BED"
"ADD/REMOVE EQUIP."

- Add or remove the equipment and press



The scale monitor will read: "RELEASE TO FIN."

- Release



The scale monitor will read: "DO NOT TOUCH BED"
"XXX.X LB"

The weight displayed will be that of the patient only.

- If the CHANGE EQUIPMENT function is started but not finished, after approximately 45 seconds the monitor will read: "HIT CH. EQ. TO END"

- Press



The scale monitor will read: "RELEASE TO FIN."

- Release



The scale monitor will read: "DO NOT TOUCH BED"
"XXX.X LB"

Converting The Patient's Weight

- Press and release



The scale monitor will read: "WEIGHT NOW KGS"
"XXX.X KG"

- Repeat the procedure to return to pounds. The display will read:

"WEIGHT NOW LBS"
"XXX.X LB"

- If the unit of measurement has been locked, the display will read:

"UNITS ARE LOCKED"









Note

A service technician must be called to unlock the unit of measurement.

Scale System Operation Guide

(Applies to Non-iBED Awareness Option Beds)

Displaying The Weight Log

- To display a list of the previous 10 weight readings, press  to activate the scale system. The scale monitor will read: “LET GO FOR SCALE”
“XXX.X LB”
- Press  to enter the Menu Mode. The scale monitor will read: “ ▲▼ FOR OPTIONS”
- Press  or  to scroll through the menu options. The scale monitor will read:
“SHOW WEIGHT LOG”
“PUSH ENTER”
- Press  The scale monitor will read: “ ▲▼ WEIGHT LOG”
- Press  or  to scroll through the weight log. The scale monitor will read: “1. 0.0 LB”
- A weight reading is logged each time the  button is pressed and the bed is in the scale mode for at least 15 seconds.

The first weight reading displayed (1.) is the most recent. If the change in the patient’s weight since the last reading was taken is less than .2 pounds, the log will not update. Zeroing the scale system clears the weight log.

Scale System Operation Guide

(Applies to Non-*i*BED Awareness Option Beds)



Viewing Patient Weight In Gain / Loss Mode

- To view the patient's weight and to begin totaling the amount of weight the patient has gained or lost, press





to activate the scale system. The scale monitor will read: "LET GO FOR SCALE"

- Press  to enter the Menu Mode. The scale monitor will read: "▲▼ FOR OPTIONS"

- Press  or  to scroll through the menu options. The scale monitor will read:
"START GAIN/LOSS"
"PUSH ENTER"

- Press  The scale monitor will read: "DO NOT TOUCH BED"
"XXX.X LB G XX.X"

- To exit Gain/Loss mode, press  to enter the Menu Mode. The scale monitor will read:
"▲▼ FOR OPTIONS"









- Press  to  to scroll through the menu options. The scale monitor will read:
"QUIT GAIN/LOSS"
"PUSH ENTER"

- Press  The scale monitor will read: "XXX.X LB"

Scale System Operation Guide

(Applies to Non-iBED Awareness Option Beds)

Changing The Numerical Value Of Displayed Weight

- To decrease the numerical value of the displayed weight, press  to activate the scale system.
The scale monitor will read: "LET GO FOR SCALE"
"XXX.X LB"
- Press  to enter the Menu Mode. The scale monitor will read: "▲▼ FOR OPTIONS"
- Press  or  to scroll through the menu options. The scale monitor will read:
"CHNG. PTNT. WGT."
"PUSH ENTER"
- Press  The scale monitor will read: "HOLD ▲ TO INC."
"▼ TO DEC."
- Press  to decrease the displayed weight or  to increase the displayed weight.
- Once the desired weight is displayed, press  The scale monitor will read: "XXX.X LB"

NOTE

If one of the load cells is malfunctioning or overloaded, the scale monitor will read: "Scale Sys. Error"
"Call for service"

Call a service technician.

Optional Pendant Operation Guide

Press to turn on the TV/Radio.

Press to increase the volume of the TV/Radio.

Press to decrease the volume of the TV/Radio.

Press to raise head section.

Press to lower head section.

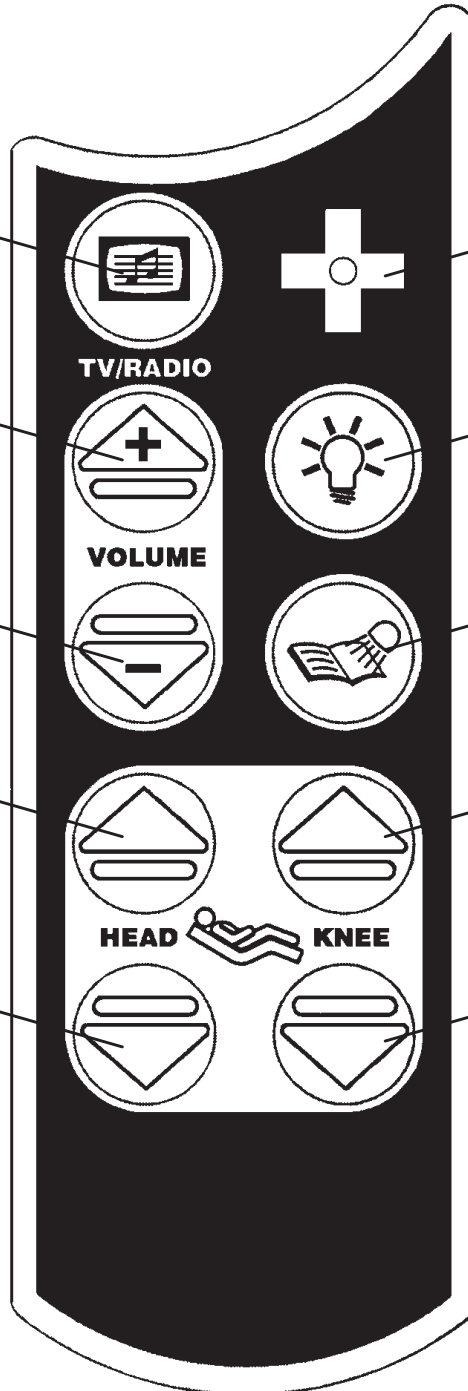

Press to activate Nurse Call.

Press to turn on room lights.

Press to turn on reading lights.

Press to raise knee section.

Press to lower knee section.

Zoom™ Option Operation Guide

Drive Wheel Operation

1. Unplug the power cord from the wall socket and secure the cord sufficiently to prevent entanglement while the unit is in motion. The drive wheel will not operate if the power cord is plugged into the wall socket.
2. Activate the power to the drive wheel by placing the battery power switch located at the left side of the head end of the litter in the “ON” position. The LED will illuminate.
3. Engage the drive wheel by rotating the pedal located at the head end to the left as shown on the label. To place the drive wheel in the neutral position, rotate the pedal to the right.
4. Release the brakes. The drive system will not function while the brakes are engaged. The “Release Brakes” LED on the head end control panel will be illuminated if the brakes are engaged while the battery power switch is on.

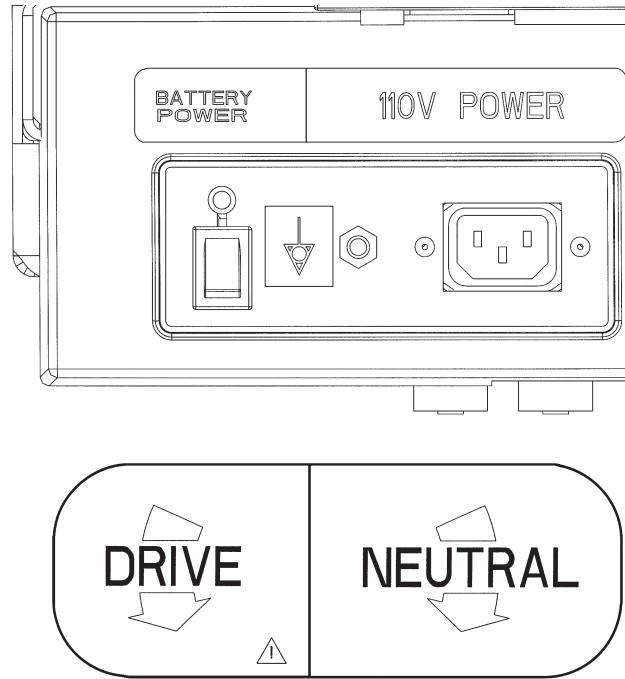

WARNING

USE CAUTION while maneuvering the unit with the drive wheel activated. Always ensure there are no obstacles near the unit while the drive wheel is activated. Injury to the patient, user or bystanders or damage to the unit or surrounding equipment could occur if the unit collides with an obstacle. Use caution when transporting the unit down halls, through doors, in and out of elevators, etc. Damage to the siderails or other parts of the unit could occur if the unit comes in contact with walls or door frames.

Zoom™ Option Operation Guide

Drive Wheel Operation (Continued)

5. Grasp the drive handle at the two raised grip areas. Squeeze either of the motion release switches (A) located under the handle to enable the movement of the drive wheel. Either or both switches will enable movement but both switches must be released to stop movement.

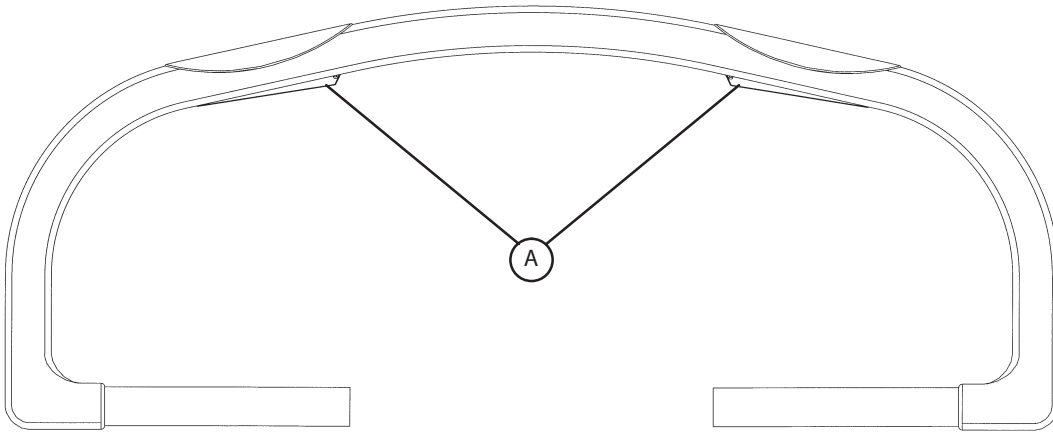

6. While continuing to squeeze the switch(es), push the handle away from you or pull the handle toward you to initiate motion in that direction. The forward speed will increase proportionally to the distance the drive handle is moved. I.E. the farther forward the drive handle is pushed, the faster the unit will move.

To stop motion, remove your hands from the switches and the handle.

NOTE

The drive wheel does not pivot. The unit cannot be moved directly sideways with the drive wheel engaged. With the drive wheel pedal in the neutral position and the unit's brakes released, the unit can be moved in any direction including sideways.

Driving a Zoom® equipped unit over liquids or slick surfaces could decrease the traction of the drive wheel.

WARNING

Put the drive wheel in the neutral position and release the brakes before pushing the unit manually. **Do not** attempt to push the unit manually with the drive wheel engaged. The unit will be difficult to push and injury could result.

CAUTION

When attaching equipment to the frame, ensure it will not impede normal operation. For example: hooks on hanging equipment must not actuate control buttons, equipment must not hide the nurse call button, etc.

Zoom™ Option Operation Guide

Head End Control Panel Operation

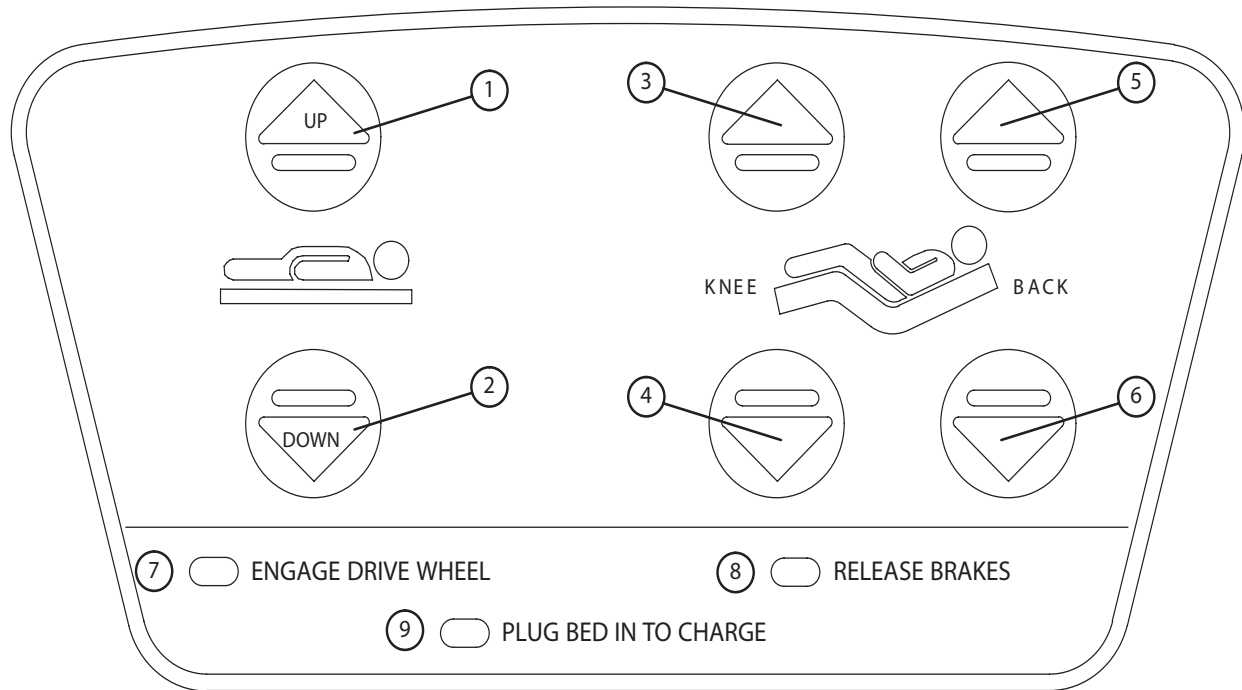

1. Press and hold to raise the litter.
2. Press and hold to lower the litter.
3. Press to raise the Knee section.
4. Press to lower the Knee section.
5. Press to raise the Back section.
6. Press to lower the Back section.
7. The “Engage Drive Wheel” LED will be illuminated whenever the battery power switch is on and the drive wheel pedal is in the neutral position. The light will go off when the drive wheel is in the drive position.
8. The “Release Brakes” LED will be illuminated whenever the bed’s brakes are engaged while the battery power switch is on. The light will go off when the brakes are disengaged.
9. The “Plug Bed In To Charge” LED will be illuminated while the battery power switch is on if the battery level is low. Plug the bed power cord into the wall socket to charge the batteries.

Zoom™ Option Operation Guide

Battery Charging And Operation

NOTE

The bed may be equipped with a battery backup option without the Zoom® drive wheel.

1. The unit has two 12 volt batteries to provide power to the drive wheel and backup power to the unit functions if the power cord is unplugged from the wall socket. Neither the unit functions nor the drive wheel will operate properly if the batteries are not sufficiently charged. The batteries require approximately 10 hours of charging time when they are fully discharged.
2. The batteries are charging whenever the power cord is plugged into a properly grounded, hospital grade wall socket. When the unit is stationary, the power cord should be plugged into a wall socket whenever possible.

NOTE

The battery will operate under slightly decreased power until it has run through 10–15 cycles of usage and recharging.

1. The “Plug Bed In To Charge” LED on the Head End Control Panel will be illuminated while the battery power switch is on if the battery level is low (see page 36). Plug the power cord into a wall socket to charge the batteries.
2. After one hour on battery power with no motion release switch activation, the unit will enter power save mode and none of the unit’s powered functions will operate. Squeeze either of the motion release switches located under the drive handle to enable the unit functions.

NOTE

The three LED’s on the Head End Control Panel may still be illuminated when the unit is in power save mode. The Battery Power LED located at the left side of the head end of the unit will be illuminated when the unit is in power save mode.

WARNING

The power save mode is activated after one hour on battery power with no motion release switch activation. Functions including Bed Exit, Scale and Motion will cease to operate when the unit enters the power save mode. Injury to the patient could occur if proper patient monitoring protocol is not observed.

Optional iBED Awareness Operation Guide

Intended Use

The iBED Awareness system is intended to serve as a secondary monitoring system, informing the operator via a visual or audible alert when a preset condition changes.

- When the iBED Awareness is turned “On”, the system has the ability to automatically monitor the following:
 - Brake Set/Not Set
 - Siderail Position
- Additionally, when the bed is in low height and/or Chaperone Bed Exit system is armed, the system has the ability to monitor these features when iBED Awareness is turned “On”.

Footboard Control Panel Buttons

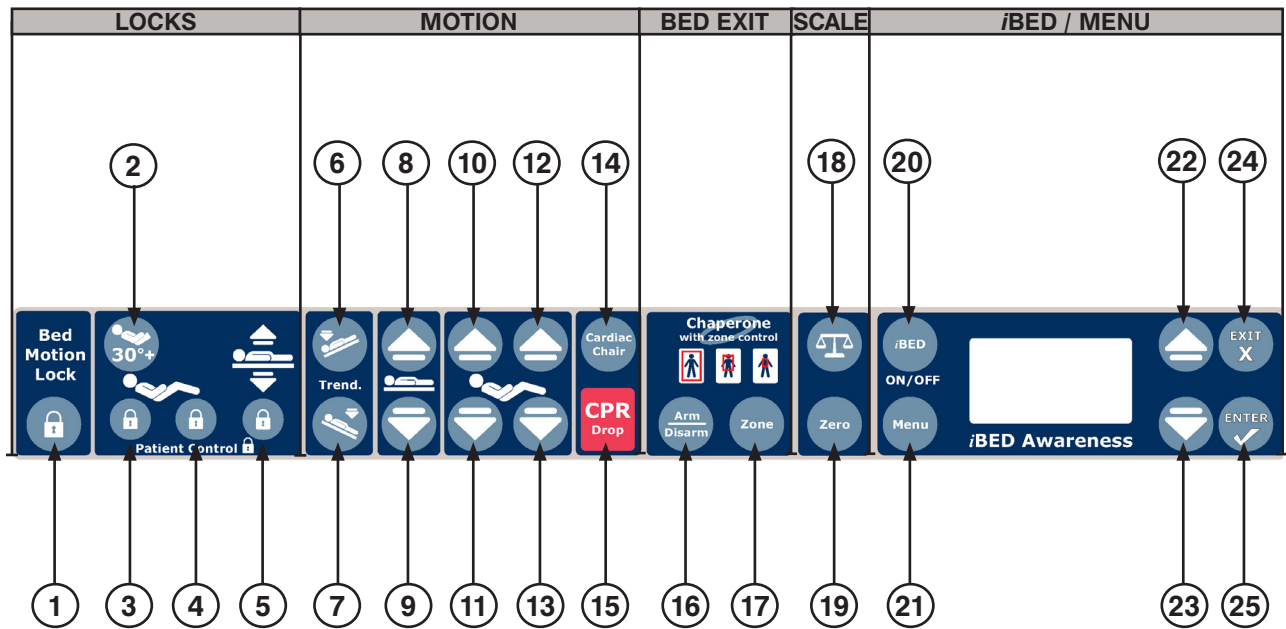

Button	Name	Button	Name	Button	Name
1	Bed Motion Lock	9	Bed Down	17	Bed Exit Zone Control
2	Fowler 30+ Lock	10	Fowler Up	18	Scale
3	Patient Fowler Lock	11	Fowler Down	19	Scale Zero
4	Patient Gatch Lock	12	Gatch Up	20	iBED On/Off
5	Patient Bed Up/Down Lock	13	Gatch Down	21	Menu
6	Trend	14	Cardiac Chair	22	Menu Up
7	Reverse Trend	15	CPR Drop	23	Menu Down
8	Bed Up	16	Bed Exit Arm/Disarm	24	Exit X
				25	Enter

[Return To Table of Contents](#)

Optional iBED Awareness Operation Guide

Footboard Control Panel Functions

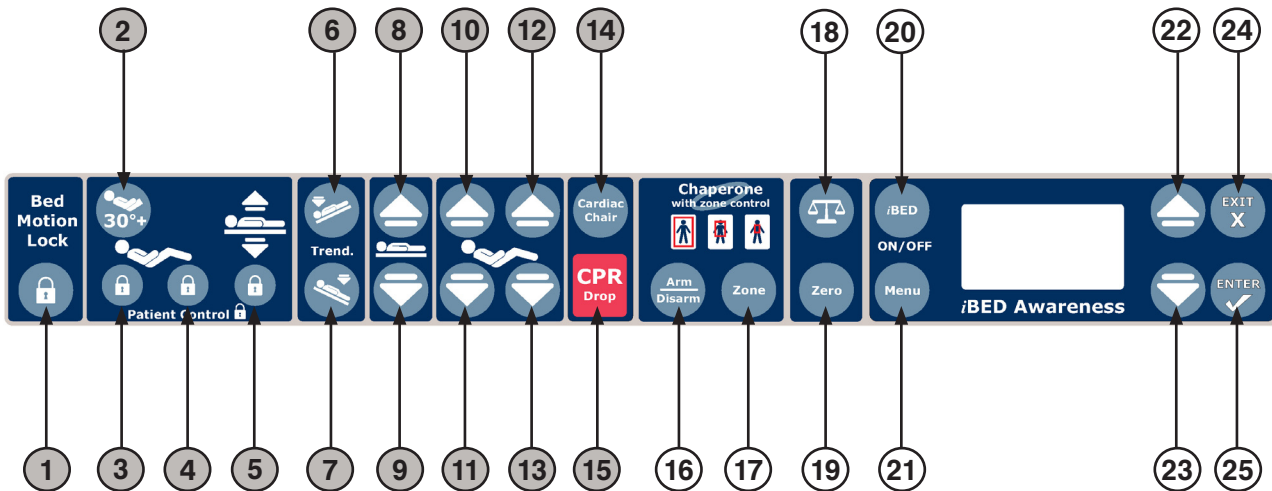

	Button	Name	Function
LOCKS	1	Bed Motion Lock	Locks all motion on bed. The Bed Motion Lock button will illuminate when activated.
	2	Fowler 30 ⁺ Lock	Places bed at 30° and locks Fowler below 30°. The Fowler 30+ button will illuminate when activated.
	3	Patient Fowler Lock	Locks out Fowler control at all locations (Siderail, Pendant, Headend) with the exception of the operator controls located on the Footboard. The Patient Fowler Lock will illuminate when activated.
	4	Patient Gatch Lock	Locks out Gatch control at all locations (Siderail, Pendant, Headend, Footboard). The Patient Gatch Lock will illuminate light when activated. This function also prevents the auto contour of the Gatch when motion is used. Note: Auto contour is the feature of the bed that when fowler is actuated, Gatch automatically moves with the Fowler.
	5	Patient Bed Up/Down Lock	Locks out Bed Height control at all locations (Siderail, Pendant, Headend) with the exception of the operator controls located on the Footboard. The Patient Bed Up/Down Lock button will illuminate light when activated.
MOTION	6	Trendelenburg	Lowers head end and raises foot end of bed.
	7	Reverse Trendelenburg	Lowers foot end and raises head end of bed
	8	Bed up	Raises bed.
	9	Bed Down	Lowers bed.
	10	Fowler Up.	Raises Fowler.
	11	Fowler Down	Lowers Fowler.
	12	Gatch Up	Raises Gatch.
	13	Gatch Down	Lowers Gatch.
	14	Cardiac Chair	When activated, the knee will raise, the Fowler will raise or lower to approximately 52° degrees and the bed will tilt to approximately -12° Reverse Trendelenburg (foot end down).
	15	CPR Drop	Activates electronic CPR function; flattens litter and puts bed in low height.

[Return To Table of Contents](#)

Optional iBED Awareness Operation Guide

Footboard Control Panel Functions (Continued)

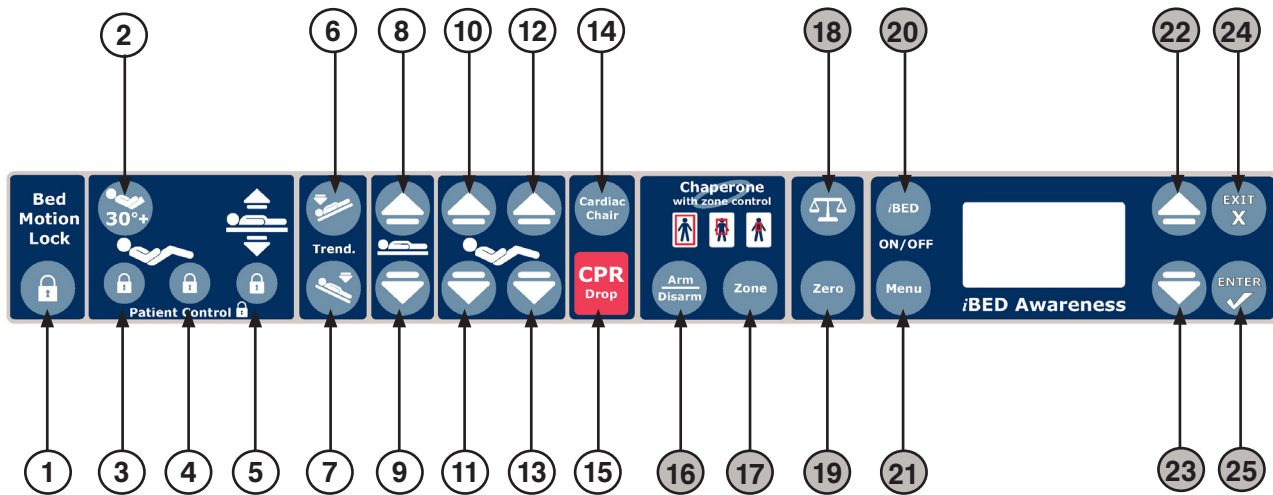

	Button	Name	Function
BED EXIT	16	Bed Exit Arm/Disarm	Activates BED EXIT system. The selected zone graphic will illuminate when activated. When Bed Exit is in alarm mode, press "Arm/Disarm" to turn Bed Exit "Off".
	17	Zone Control	Changes the Zone.
SCALE	18	Scale	Turns Scale system ON/OFF.
	19	Zero	Zeroes Bed.
iBED/MENU	20	iBED On/Off	Turns iBED Awareness system ON/OFF.
	21	Menu	Access MENU selections.
	22	Menu Up	Scroll Up through menu.
	23	Menu Down	Scroll Down through menu.
	24	Exit X	Exits or Escapes from menu selection; also used to Save and/or Cancel operations.
	25	Enter ✓	Selects menu item; also used to Save and/or Cancel operations.

Note

iBED Awareness options populated with Chaperone Bed Exit features without Zone Control will not have button 17.

[Return To Table of Contents](#)

Optional iBED Awareness Operation Guide

LED Indicators: Footboard

The LED's inform the operator of various product conditions as listed below.

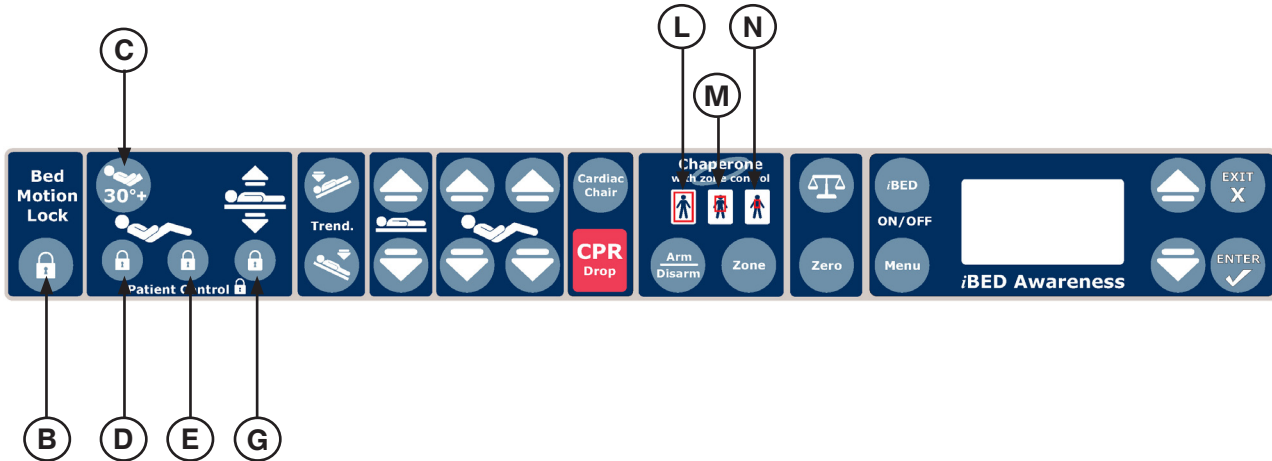

Button	Name: Function	LED Indicator
B	Bed Motion Lock LED: LED is illuminated if Bed Motion is locked; blinking if motion is attempted when lock is "On".	AMBER
C	Fowler 30+ Lock LED: LED is illuminated if Fowler 30+ is locked; blinking if locked and motion is attempted; flashing if lock condition is violated by CPR.	AMBER
D	Patient Control Fowler Lock LED: LED is illuminated if the Patient Fowler Lock is "On".	AMBER
E	Patient Control Gatch Lock LED: LED is illuminated if the Patient Gatch Lock is "On".	AMBER
G	Patient Control Bed Up/Down Lock LED: LED is illuminated if the Patient Bed Up/Down Lock is "On".	AMBER
L	Zone 1 LED: LED is illuminated when Bed Exit is "On" and Zone 1 activated.	AMBER
M	Zone 2 LED: LED is illuminated when Bed Exit is "On" and Zone 2 activated.	AMBER
N	Zone 3 LED: LED is illuminated when Bed Exit is "On" and Zone 3 activated.	AMBER

Note

iBED Awareness options populated with Chaperone Bed Exit features without Zone Control will not have items M or N.

Optional *i*BED Awareness Operation Guide

LED Indicators: Dashboard

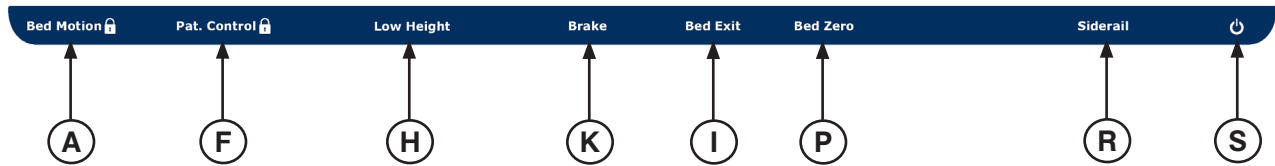

Button	Name: Function	LED Indicator
A	Bed Motion Lock LED: LED is illuminated when Bed Motion Lock is activated.	AMBER
F	Patient Control Lock LED: LED is illuminated when any of the Patient Control (Fowler, Gatch, Bed Up/Down) Lock buttons are activated.	AMBER
H	Low Height LED: LED is illuminated when bed is in low height. The LED will blink if the <i>i</i> BED Awareness system is “On”, the low height is being monitored, and the bed is not in low height.	AMBER
I	Bed Exit LED: LED is illuminated when the Bed Exit is armed. The LED will blink if the Bed Exit is turned Off while the <i>i</i> BED Awareness system is turned On.	AMBER
K	Brake LED: LED is illuminated when the brake is set, and will blink if the brake is not set.	AMBER
P	Bed Zero LED: LED is illuminated if Bed Zero is successful.	AMBER
R	Siderail LED: LED is illuminated if <i>i</i> BED Awareness system is “On”. The LED will blink when siderail state has changed.	AMBER
S	Power LED: LED is illuminated when bed has power.	GREEN

Optional iBED Awareness Operation Guide

Display Screens

There are 5 types of display screens listed by priority below with one being the highest.

Types

Screen	Type	Priority
Alarm Indications	Bed Exit Alarm Message	1
	Brake Alarm Message	2
Messages	iBED Awareness Alert Messages	3
	Conditional Message	4
Menus	Main Menu	5
Status Screen	Default Screen	6

Power Up

The initialization screen shown in Figure 1 will be displayed on power up.



Figure 1

Status Screen

- The status screen is the default screen.
- Information on this screen includes the 'Fowler Angle' and the 'Trend Angle' values.
- If this screen is inactive for 60 seconds, the Backlighting will be reduced.
- Figure 2 shows an example of the "Status" Screen:

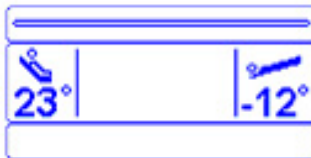

Figure 2

Message Screen

- As required message screens are provided during alarm conditions and user interaction with the bed.

Optional iBED Awareness Operation Guide

Display Screens (Continued)

Main Menu Screen

- The Main Menu contains selectable product features to the caregiver.
- There are eight features listed in the main menu as ordered below:
 1. Weight Log (Weight Log is the Default Selection)
 2. Gain/Loss
 3. Change Equip. (Change Equipment)
 4. Change Ptnt. Wgt. (Change Patient Weight)
 5. Scale Units (Change Scale Units)
 6. Backlight (Backlighting)
 7. Advanced Options
 8. Exit Menu
- To select a feature, press the “Menu Up” and “Menu Down” button to scroll to the desired feature and press the “Enter/√” button.

1. Weight Log

- This feature provides the operator with up to 10 of the last weights logged by the scale system as shown in Figure 3.



Figure 3

2. Gain/Loss

- This feature provides information to the caregiver on the weight gain or loss of the patient.

To enable:

- Select “Gain/Loss” in the menu then press the “Enter/√” button, Figure 4 will be displayed.
- When “**Release Button**” message flashes on the display, release the “Enter/√” button; “**Do Not Touch Bed**” message will flash on the display.
- When Gain/Loss is On, “**Gain/Loss Enable**” message displays.



Figure 4

NOTE: Refer to Figure 5

- The base represents the scale weight when the gain/loss feature was enabled.
- The second piece of information represents the “Gain” or the “Loss” and the weight difference between the current displayed weight and the saved base weight.



Figure 5

NOTE: Refer to Figure 6

- If the Gain or the Loss exceeds 99.9 lb, then the system will display ‘---’ instead of a value.



Figure 6

Optional iBED Awareness Operation Guide

Display Screens (Continued)

Main Menu (Continued)

3. Change Equipment

The change equipment feature allows the operator to add or remove item from the product without affecting the patient weight.

To Change Equipment:

- Select “Change Equip.” in the menu then press the “Enter/√” button, Figure 7 will be displayed.
- When **“Release to Start”** message displays on the screen, release the “Enter/√” button; **“Do Not Touch Bed”** message will flash on display.
- Figure 8 will display when the system is ready to change equipment.
- Press the “Enter/√” button to Add/Remove equipment or press the “Exit/X” button to cancel operation.
 - If “Enter/√” is pressed to Add/Remove Equipment then the message **“Do Not Touch Bed”** will flash on the display.
 - If “Exit/X” is pressed, **“Operation Canceled”** message will display.
- Figure 9 will be displayed when the system completes the change equipment adjustment.



Figure 7



Figure 8



Figure 9

4. Change Patient Weight

The change patient feature allows the operator to add or remove weight from the patient weight.

To Change Patient Weight:

- Select “Change Pnt. Wgt.” in the menu.
- Press and hold the “Enter/√” button, Figure 10 will be displayed.
- When **“Release Button”** message displays on the screen, release the “Enter/√” button; **“Do Not Touch Bed”** message will flash on display.
- When the system is ready to change patient weight the following information will be displayed:
 - Allow used to Change patient Weight using arrow button;
 - Display the new patient weight;
 - Press “Enter/√” when done;
 - Press “Exit/X” to cancel operation.
- If “Enter/√” is pressed, the message **“Do Not Touch Bed”** will flash on the display.
- If “Exit/X” is pressed, **“Patient Weight Changed”** message will display.

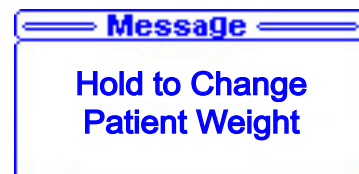

Figure 10

Optional iBED Awareness Operation Guide

Display Screens (Continued)

Main Menu (Continued)

5. Scale Units

- The Change Scale Units feature allows the operator to select the unit of value (lb or kg) for the scale information that is presented on the display.
- When the change scale units is selected, Figure 11 is displayed.
- This screen will highlight the current scale unit setting.
- To change the scale unit setting, scroll to the desired setting and press the “Enter/√” button.
- The default setting is “Pounds [lb]”



Figure 11

6. Backlight

- When the backlight feature is selected the display will change to the backlight selection screen as shown in Figure 12.
- This screen will highlight the current backlight setting.
- Five settings are available for the backlight; Off, Low, Medium, High, and Nurse Call Only.
- To change the backlight setting; scroll to the desired setting and press the “Enter/√” Button; “Save Successful” message will display.
- The default setting is “Low”.

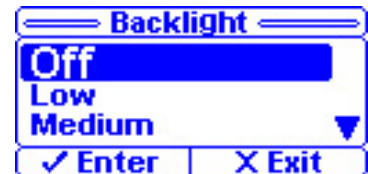

Figure 12

7. Advanced Options

The advanced menu items include:

1. Choose Exit Alarm
2. Brake Alarm
3. Bed Status Alarm
4. Status to N/C

Choose Exit Alarm

The caregiver can choose between 10 exit alarms.

To Select Alarm:

- Select “Choose Exit Alarm” from the menu.
- Scroll through the 10 Tone Patterns listed in the menu. A sample alarm will sound for each Tone Pattern highlighted.
- Select desired Tone Pattern and Press “Enter/√”
- “Save Successful” message will be displayed.

Optional *i*BED Awareness Operation Guide

Display Screens (Continued)

Main Menu / Advanced Options (Continued)

Brake Alarm

The caregiver can enable or disable a brake alarm feature. If the brakes are not engaged and the bed is plugged in an audible alarm will occur. This feature is only available on non-Zoom beds.

To Enable/Disable Brake Alarm:

- Select “Brake Alarm” from the menu.
- Use the Up and Down Arrow buttons to select enable or disable the alarm.
- Press “Enter/✓” to save the alarm state.
- “**Save Successful**” message will be displayed.

Bed Status Alarm (*i*BED Awareness Audible Alarm)

The caregiver can enable or disable an audible alarm for *i*BED Awareness alert states.

To Enable/Disable Alarm:

- Select “Bed Status Alarm” from the menu.
- Select “On” to Enable or “Off” to disable and then press “Enter/✓”
- “**Save Successful**” message will be displayed.

Status Nurse Call (*i*BED Awareness Priority Signal)

The caregiver can enable or disable a priority signal alarm through the Nurse call system based on an *i*BED Awareness alarm state.

To Enable/Disable Alarm:

- Select “Status to N/C” from the menu.
- Select “On” to Enable or “Off” to disable and then press “Enter/✓”
- “**Save Successful**” message will be displayed.

8. Exit Menu

Exits Main Menu screen and returns display to the default Status Screen.

Optional *i*BED Awareness Operation Guide

***i*BED Awareness Functionality**

- The *i*BED Awareness provides functionality that will monitor status conditions on the product and produce an alert if the state had changed.
- When the system is turned “On”, it monitors each of the siderail positions and brake automatically. If the bed is in Low Height and/or Bed Exit is armed, the system will also monitor these features when bed status is turned “On”.
- In the event of a power loss, the *i*BED Awareness system will operate in the last known condition when power is restored.
- *i*BED Awareness will not be able to be turned “On” if any system error conditions exist that impede the function of the *i*BED Awareness system. The system errors that affect this feature include the four side rail sensors and the scale system. For details on error codes, refer to the Maintenance Manual.

***i*BED Awareness Light Bar**

A light bar, located centrally on the front of the footboard, will illuminate and indicate the state of the *i*BED Awareness system.

Features

- When the *i*BED Awareness system is “On” the light bar turns green.
- If an alert state on the *i*BED Awareness system is triggered, the light bar will change to the alert state and flash AMBER.
- During an alert state, an AMBER dashboard LED associated with the alert will blink on the footboard and the display screen will show the details of the alert state.

***i*BED Awareness Side LED’s**

LEDs, located on each side of the bed near the foot end, will provide an indication of an alert state.

Features

- If an alert state on the *i*BED Awareness system is triggered, the side LEDs will change to the alert state and blink AMBER.
- During an alert state, an AMBER dashboard LED associated with the alert will blink on the footboard and the display screen will show details of the alert state.

***i*BED Awareness Button**

The *i*BED control button is used to turn the *i*BED Awareness system “On” and “Off”.

Features

When the button is pressed the *i*BED Awareness system will save information based on the current state of the product and based on the system rules.

Turning on the *i*BED Awareness system

1. Press the *i*BED On/Off button.
2. The following message will be displayed on the screen: **“Bed Status On”**.

Turning off the *i*BED Awareness system

1. Press and hold the *i*BED On/Off button.
2. The following message will be displayed on the screen: **“Bed Status Off”**.

Optional iBED Awareness Operation Guide

iBED Awareness Monitoring and Alarms

Low Height

- If the low height state changes:
 1. The low height LED on the dashboard blinks and the display screen flashes between Figure 13 message and Figure 14 message.



Figure 13

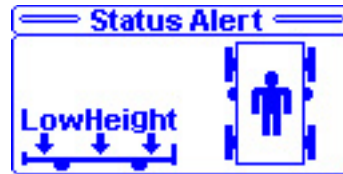

Figure 14

Brakes

- If the brake state changes:
 1. The brake LED on the dashboard blinks and the display screen flashes between Figure 15 message and Figure 16 message.



Figure 15



Figure 16

Siderails

- If the siderail state changes:
 1. The siderail LED on the dashboard blinks and the display screen flashes between Figure 17 message and Figure 18 message.



Figure 17



Figure 18

Note

The arrow pointing to the siderail in Figure 17 and 18 will change depending on the siderail position in alarm.

Optional iBED Awareness Operation Guide

iBED Awareness Monitoring and Alarms (Continued)

Bed Exit

- If the bed exit is disarmed:
 1. The bed exit LED on the dashboard blinks and the display screen flashes between Figure 19 message and Figure 20 message.



Figure 19



Figure 20

Additional Alarm Conditions

- If an audible alarm is required, the caregiver can set the bed status alarm to "On" through the Advanced Options Menu in the Main Menu.
- If the caregiver would like to set the bed status alarm to the Nurse Call Station, the "Status to N/C" must be turned "On" through the Advanced Options Menu in the Main Menu.

Note

- By default these two advanced options are turned "Off".

iBED Awareness Locks

Fowler 30⁺ Lock button

- The Fowler 30+ Lock is a dual purpose button. It positions the bed's fowler 30° to the horizontal and locks any Fowler motion below 30°.
- When the Fowler 30+ button is pressed, the bed will reposition only if it is below 30° and Figure 21 will be displayed.
- Once the bed reaches its final position (Trend Angle = 0°, Fowler Angle = 30°), Figure 22 will be displayed.
- If the button is not held until the final position is reached Figure 23 will be displayed.
- If bed is put in CPR position manually or by pressing the CPR button, Figure 24 will be displayed.



Figure 21



Figure 22



Figure 23



Figure 24

Optional iBED Awareness Operation Guide

iBED Awareness Locks (Continued)

Bed Motion Lock

- If Bed Motion lock button is pressed Figure 25 will be displayed.
- If Bed Motion lock button is pressed when already “on” then Figure 26 will be displayed.



Figure 25



Figure 26

- If Motion is attempted when lock is “On”, Figure 27 and 28 are displayed.

Note: CPR Drop button overrides locks.



Figure 27



Figure 28

Patient Control Locks

- If the Patient Control lock button is pressed Figure 25 as shown above will be displayed.
- If the Patient Control lock button is pressed when already “on” then Figure 26 as shown above will be displayed.

Cleaning

Hand wash all surfaces of the bed with warm water and mild detergent. DRY THOROUGHLY. Do not steam clean or hose off the Secure II Bed. Do not immerse any part of the bed. Some of the internal parts of the bed are electric and may be damaged by exposure to water.

Suggested cleaners for bed surfaces:

- Quaternary Cleaners (active ingredient – ammonium chloride)
- Phenolic Cleaners (active ingredient – o-phenylphenol)
- Chlorinated Bleach Solution (5.25% – less than 1 part bleach to 100 parts water)

Avoid over saturation and ensure the product does not stay wet longer than the chemical manufacturer's guidelines for proper disinfecting.

CAUTION

SOME CLEANING PRODUCTS ARE CORROSIVE IN NATURE AND MAY CAUSE DAMAGE TO THE PRODUCT IF USED IMPROPERLY. If the products described above are used to clean Stryker patient care equipment, measures must be taken to insure the beds are wiped with a damp cloth soaked in clean water and thoroughly dried following cleaning. Failure to properly rinse and dry the beds will leave a corrosive residue on the surface of the bed, possibly causing premature corrosion of critical components. Failure to follow the above directions when using these types of cleaners may void this product's warranty.

For mattress cleaning instructions, please see the tag on the mattress, or contact the mattress manufacturer.

Clean Velcro AFTER EACH USE. Saturate Velcro with disinfectant and allow disinfectant to evaporate. (Appropriate disinfectant for nylon Velcro should be determined by the hospital).

Preventative Maintenance

CHECKLIST

- _____ All fasteners secure (reference all assembly prints).
- _____ Engage brake pedal and push on the bed to ensure all casters lock securely.
- _____ “Brake Not Set” LED on the foot board (*iBED Awareness option only*) blinks when brakes are not engaged.
- _____ “Brake” LED on the foot board (*iBED Awareness option only*) blinks when brakes are not engaged.
- _____ Locking steer caster engages and disengages properly.
- _____ Siderails move, latch and stow properly.
- _____ CPR release working properly.
- _____ Optional foot prop intact and working properly.
- _____ I.V. pole working properly.
- _____ Foley bag hooks intact.
- _____ Optional CPR board not cracked or damaged and stores properly.
- _____ No cracks or splits in head and foot boards.
- _____ No rips or cracks in mattress cover.
- _____ All functions on head end siderails working properly (including LED's).
- _____ All functions on footboard working properly (including LED's).
- _____ Scale and Bed Exit system calibrated properly.
- _____ Motion Interrupt switches working properly.
- _____ Night light working properly.
- _____ Power cord not frayed.
- _____ No cables worn or pinched.
- _____ All electrical connections tight.
- _____ All grounds secure to the frame.
- _____ Ground impedance not more than 100 milliohms.
- _____ Current leakage not more than 300 microamps.
- _____ Apply grease to litter grease points.
- _____ Engage drive wheel and ensure it is operating properly (Zoom option).
- _____ Motion release switches working properly (Zoom option).
- _____ Confirm Head End Control Panel functionality (Zoom option).
- _____ Confirm battery powered functionality (Zoom option).
- _____ Ensure ground chains are clean, intact, and have at least two links touching the floor.
- _____ Siderail switches working properly (*iBED Awareness option*).
- _____ Bed Status Light Bar LEDs working properly (*iBED Awareness option*).
- _____ Bed Status Side Indicator LEDs working properly (*iBED Awareness option*).
- _____ Inspect footboard control labeling for signs of degradation (*iBED Awareness option*).

Bed Serial Number:		

Completed by: _____ Date: _____

Warranty

Limited Warranty

Stryker Medical Division, a division of Stryker Corporation, warrants to the original purchaser the Secure II Med-Surg Bed to be free from defects in material and workmanship for a period of one (1) years after date of delivery. Stryker's obligation under this warranty is expressly limited to supplying replacement parts and labor for, or replacing, at its option, any product which is, in the sole discretion of Stryker, found to be defective. If requested by Stryker, products or parts for which a warranty claim is made shall be returned prepaid to the factory. Any improper use or any alteration or repair by others in such manner as in Stryker's judgment affects the product materially and adversely shall void this warranty. Any repair of Stryker products using parts not provided or authorized by Stryker shall void this warranty. No employee or representative of Stryker is authorized to change this warranty in any way.

Stryker Medical Bed products are designed for a 15 year expected service life under normal use, conditions, and with appropriate periodic maintenance as described in the maintenance manual for each device. Stryker warrants to the original purchaser that the welds on its Bed products will be free from structural defects for the expected 15 year life of the Bed product as long as the original purchaser owns the product.

This statement constitutes Stryker's entire warranty with respect to the aforesaid equipment. **Stryker makes no other warranty or representation, either expressed or implied, except as set forth herein. There is no warranty of merchantability and there are no warranties of fitness for any particular purpose. In no event shall Stryker be liable here under for incidental or consequential damages arising from or in any manner related to sales or use of any such equipment.**

To Obtain Parts and Service

Stryker products are supported by a nationwide network of dedicated Stryker Field Service Representatives. These representatives are factory trained, available locally, and carry a substantial spare parts inventory to minimize repair time. Simply call your local representative, or call Stryker Customer Service USA at 1-800-327-0770, Canada 1-888-233-6888.

Service Contract Coverage

Stryker has developed a comprehensive program of service contract options designed to keep your equipment operating at peak performance at the same time it eliminates unexpected costs. We recommend that these programs be activated before the expiration of the new product warranty to eliminate the potential of additional equipment upgrade charges.

A Service Contract helps to:

- Ensure equipment reliability
- Stabilize maintenance budgets
- Diminish downtime
- Establish documentation for JCAHO
- Increase product life
- Enhance trade-in value
- Address risk management and safety

Warranty

Service Contract Programs

Stryker offers the following service contract programs:

Service Agreement Options *	Gold	Silver	Parts	Labor	PM
Annually scheduled preventative maintenance	X				X
All parts	X	X	X		
All labor and travel	X	X		X	
Unlimited emergency service calls	X	X		X	
Priority one contact: two hour phone response	X	X	X	X	
Most repairs completed within 3 days	X	X		X	
JCAHO documentation	X	X		X	X
On-site record of PM & emergency service	X				X
Factory-trained Stryker service technician	X	X		X	X
Stryker authorized parts used	X	X	X	X	X
Service during regular business hours (8–5)	X	X	X	X	X

* Does not include maintenance due to abuse or for any disposable items. Stryker reserves the right to change options without notice.

Stryker Medical also offers personalized service contracts.
Pricing is determined by age, location, model and condition of product.

**For more information on our service contracts,
please call your local representative.**

Return Authorization

Merchandise cannot be returned without approval from the Stryker Customer Service Department. An authorization number will be provided which must be printed on the returned merchandise. Stryker reserves the right to charge shipping and restocking fees on returned items. **Special, modified, or discontinued, items not subject to return.**

Damaged Merchandise

ICC Regulations require that claims for damaged merchandise must be made with the carrier within fifteen (15) days of receipt of merchandise. **Do not accept damaged shipments unless such damage is noted on the delivery receipt at the time of receipt.** Upon prompt notification, Stryker will file a freight claim with the appropriate carrier for damages incurred. Claim will be limited in amount to the actual replacement cost. In the event that this information is not received by Stryker within the fifteen (15) day period following the delivery of the merchandise, or the damage was not noted on the delivery receipt at the time of receipt, the customer will be responsible for payment of the original invoice in full. Claims for any short shipment must be made within thirty (30) days of invoice.

International Warranty Clause

This warranty reflects U.S. domestic policy. Warranty outside the U.S. may vary by country. Please contact your local Stryker Medical representative for additional information.

[Return To Table of Contents](#)

UNITED STATES
Stryker Medical
3800 E. Centre Ave.,
Portage, Michigan USA
49002

CANADA
Stryker Canada
45 Innovation Drive
Hamilton, Ontario Canada
L9H 7L8

EC	REP
----	-----

European Representative
Stryker France
ZAC Satolas Green Pusignan
Av. De Satolas Green
69881 MEYZIEU Cedex
France

stryker[®]