

S3[®] MedSurg Bed

REF 3002















Battery Backup / Zoom[®]

stryker[®]

Operations Manual



Symbols

	Warning, consult accompanying documentation
	Safe Working Load Symbol
	Dangerous Voltage Symbol
	Alternating Current
	Direct Current
	Protective Earth Terminal
	Potential Equalization Symbol
	<p>Type B Equipment: equipment providing a particular degree of protection against electric shock, particularly regarding allowable leakage current and reliability of the protective earth connection.</p> <p>Class 1 Equipment: equipment in which protection against electric shock does not rely on BASIC INSULATION only, but which includes an additional safety precaution in that means are provided for the connection of the EQUIPMENT to the protective earth conductor in the fixed wiring of the installation in such a way that ACCESSIBLE METAL PARTS cannot become live in the event of a failure of the BASIC INSULATION.</p> <p>Mode of Operation: Continuous</p>
IPX4	Protection from liquid splash
	Medical Equipment Classified by Underwriters Laboratories Inc. with Respect to Electric Shock, Fire, Mechanical and Other Specified Hazards Only in Accordance with UL 60601-1, First Edition (2003) and CAN/CSA C22.2 No. 601.1-M90 with updates 1 and 2 and IEC 60601-1 (1998) with Amendment 1 (1991) and Amendment 2 (1995).
	In accordance with European Directive 2002/96/EC on Waste Electrical and Electronic Equipment, this symbol indicates that the product must not be disposed of as unsorted municipal waste, but should be collected separately. Refer to your local distributor for return and/or collection systems available in your country.
	Non-ionizing radiation; i.e. RF transmitter (WiFi)
	This icon means the iBed Locator is connected.
	This icon means the iBed Locator is not connected.
	This icon means the Network is connected.
	This icon means the Network is not connected.

[Return To Table of Contents](#)

Table of Contents

Symbols	3
Warning/Caution/Note Definition	7
Introduction	8
Intended Use – Stryker S3® MedSurg Bed, Model 3002	8
Intended Use – <i>i</i> Bed® Wireless with <i>i</i> Bed® Awareness	8
Expected Service Life	9
Specifications	9
Mattress Specifications	10
Environmental Conditions	10
Product Illustration	11
Contact Information	12
Serial Number Location	12
Summary of Safety Precautions	13
Zoom® Option	15
<i>i</i> Bed® Wireless Option	16
Setup	17
Zoom® Option	18
<i>i</i> Bed® Wireless Option	18
Operation	19
Brake Pedal Operation	19
Steer Pedal Operation (Beds without the Zoom® Drive Wheel Option)	19
CPR Emergency Release	19
Foot Prop Usage	20
Fracture Frame Usage	20
Foley Bag Hooks Usage	20
Patient Restraint Strap Locations	20
Night Light Usage	20
Positioning Siderails	21
Control Panel Lights	21
Operating IV Poles	22
Nurse Call Backup Battery (Optional)	23
1/4 in Nurse Call Port (Optional)	23
Using the 110 Volt Outlet (Optional)	23
Nurse Control Functions (Outside Siderail)	24
Patient Control Functions Without Optional Smart TV (Inside Siderail)	25
Patient Control Functions With Optional Smart TV (Inside Siderail)	26
Patient TV Channel Control Functions with Optional Smart TV (Inside Siderail)	27
Footboard Control Panel	28
Footboard LED Indicators	31
Display Screens	33
Chaperone Bed Exit (Optional)	34
Chaperone Bed Exit With Zone Control (Optional)	35
Scale System (Optional)	36
<i>i</i> Bed Awareness Intended Use	42
<i>i</i> Bed® Awareness Functionality	42
<i>i</i> Bed® Awareness Light Bar And Side Lights	42

Table of Contents

Operation (Continued)	
<i>i</i> Bed® Awareness ON/OFF Button	42
<i>i</i> Bed® Awareness Monitoring and Alarms	43
Low Height	43
Brakes.	43
Siderails	43
Bed Exit.	44
Fowler 30°+ Lock.	44
Additional Alarm Conditions	44
<i>i</i> Bed® Awareness Locks	45
Fowler 30°+ Lock button	45
Bed Motion Lock	45
Patient Control Locks	45
Battery Backup Panel (Optional).	46
Zoom Motorized Drive Panel (Optional).	47
Zoom Motorized Drive Operation	48
Battery Charging And Operation.	50
Pendant - Motion/Nurse Call (3006-315-011).	51
Pendant - Motion/Nurse Call/Smart Tv (Digital) (3006-315-012).	51
Optional Infrared (IR) Module	52
Optional <i>i</i> Bed Locator	53
Preventive Maintenance	54
Checklist	54
Grease Points	55
Cleaning.	56
Product Labels	57
Recycling Passport	67
EMC Information.	77
Warranty	81
Limited Warranty	81
Warranty Exclusion and Damage Limitations.	81
To Obtain Parts and Service	81
Return Authorization.	81
Damaged Merchandise	81
International Warranty Clause.	81

Warning/Caution/Note Definition

The words **Warning**, **Caution** and **Note** carry special meanings and should be carefully reviewed.

WARNING

Alerts the reader about a situation, which if not avoided, could result in death or serious injury. It may also describe potential serious adverse reactions and safety hazards.

CAUTION

Alerts the reader of a potentially hazardous situation, which if not avoided, may result in minor or moderate injury to the user or patient or damage to the equipment or other property. This includes special care necessary for the safe and effective use of the device and the care necessary to avoid damage to a device that may occur as a result of use or misuse.

Note

This provides special information to make maintenance easier or important instructions clearer.

Introduction

This manual is designed to assist you with the operation or maintenance of the Stryker S3[®] MedSurg Bed, Model 3002. Read this manual thoroughly before operating or maintaining this product. Establish methods and procedures for educating and training staff on the safe operation or maintenance of this product.

WARNING

- Improper usage of the product can cause injury to the patient or operator. Operate the product only as described in this manual.
 - Do not modify the product or any components of the product. Modifying the product can cause unpredictable operation resulting in injury to patient or operator. Modifying the product also voids its warranty.
-

Notes

- This manual should be considered a permanent part of the product and should remain with the product even if the product is subsequently sold.
- Stryker continually seeks advancements in product design and quality. Therefore, while this manual contains the most current product information available at the time of printing, there may be minor discrepancies between your product and this manual. If you have any questions, please contact Stryker Customer Service or Technical Support at 1-800-327- 0770.

INTENDED USE – STRYKER S3[®] MEDSURG BED, MODEL 3002

The S3[®] MedSurg Bed, Model 3002 is intended to support and transport patients within the Med/Surg and Critical Care hospital environments. The S3[®] MedSurg Bed, Model 3002 is typically used in pre-op, post-op and recovery areas of hospital facilities. The intended user for this product is both Health Care Providers (HCPs: nurses, nurses' aides, and medical doctors) and human patients. Lockout features may limit patient accessible controls. This product is to be used in combination with a patient sleep surface. The bed has fowler, gatch and lift articulation capabilities that aide in the adjustment of surface contour, angle, and height. The product offers various options, outlined in the product operations and maintenance manuals, including but not limited to *iBed*[®] Awareness, scale, 110V option, IV pole, defibrillator tray, etc. *iBed*[®] Awareness allows users to set various bed parameters to monitor bed positioning. Chaperone[®] Bed Exit system alerts inform users as to patient movement within a specific zone(s) on a patient surface. Both the *iBed* Awareness and Chaperone[®] Bed Exit system provide both visual and audible alerts. The bed may be equipped with an integrated scale intended to weigh the patient in bed. The scale output is not intended to be used to determine diagnosis or treatment.

The intended patient population for the S3[®] MedSurg Bed, Model 3002 is as follows:

- The product should be used with patients upwards of 50 lb and have a safe working load of 500 lb
- The patient must be at least 2 years old
- The patient must be less than 84 in without a bed extender OR 96 in with a bed extender

The product is not intended to support more than one individual at a time.

INTENDED USE – *iBED*[®] WIRELESS WITH *iBED*[®] AWARENESS

The intended use for the *iBed*[®] Wireless (with *iBed*[®] Awareness) is to assist clinical staff to monitor bed parameters on specific Stryker beds. The desired bed parameters will be set by clinicians at the bedside. The *iBed*[®] Wireless software is intended to be used only with specifically enabled Stryker beds that have been verified and validated with the *iBed*[®] Wireless software, and is not intended to provide bed status information for non-Stryker beds. The *iBed*[®] Wireless software is not intended to communicate any patient status information, nor to permanently store any type of data. The *iBed*[®] Wireless with *iBed*[®] Awareness System is not intended to provide automated treatment decisions or as a substitute for professional healthcare judgment. The *iBed*[®] Wireless with *iBed*[®] Awareness System is not a replacement or substitute for vital signs monitoring or alert equipment. All patient medical diagnosis and treatment are to be performed under direct supervision and oversight of an appropriate health care professional.

Introduction

EXPECTED SERVICE LIFE

The S3® MedSurg Bed, Model 3002 has an expected service life of 10 years under normal use conditions and with appropriate periodic maintenance as described in the maintenance manual for each device.

SPECIFICATIONS

	Safe Working Load Note: Safe Working Load indicates the sum of the patient, mattress, and accessory weight.		500 lbs	227 kg
Bed Weight			570 lbs	259 kg
Scale System Capacity (optional equipment). Loads weighing up to			500 lbs	227 kg
Scale System Accuracy (optional equipment)			± 3 pounds for patients weighing 50 to 100 pounds ± 3% of the total patient weight for patients weighing 100 to 500 pounds	
Overall Length/Width	Battery Backup / Zoom® Bed	Siderails Up	95" x 41-1/2"	241,3 cm x 105,4 cm
		Siderails Down	95" x 39-1/2"	241,3 cm x 100,3 cm
Patient Sleep Surface			84" x 35"	213,4 cm x 88,9 cm
Bed Height to Top of Seat Litter - 6" Casters		Beds with Battery Backup / Zoom®	19.5" to 30"	49,5 cm to 76,2 cm
Litter Platform to Top of Siderail	Full Up	Head End Siderail	15"	38,1 cm
	Full Up	Foot End Siderail	15-1/2"	39,37 cm
Space Between Siderails (Full Up)			2-1/4"	5,72 cm
Knee Gatch Angle			0° to 45°	
Fowler Angle			0° to 60°	
Trendelenburg/Reverse Trendelenburg			+10° to -10° ± 1°	
Electrical Requirements - all electrical requirements meet UL 2601 specifications.			115VAC, 60Hz, 8A	
/Bed® Wireless (option)			802.11 b/g, 2.4 GHz <ul style="list-style-type: none"> • Minimum Operational Signal Strength: -65 dB • Supported Securities: <ul style="list-style-type: none"> WEP WPA-PSK (TKIP) WPA2-PSK (CCMP/AES) • Supports IPv4 and DHCPv4 802.1x <ul style="list-style-type: none"> • MS-CHAPv2 	
Battery Voltage			(2) 12V 31Ah - Battery Backup/Zoom® (Gel Cell Battery) (1) 9V - Nurse Call Option (Alkaline Battery)	

Introduction

MATTRESS SPECIFICATIONS

Thickness	6"	15.2 cm
Width	>= 35"	>= 88.9 cm
Length	>= 84"	>= 213.4 cm
ILD	80 lbs	36.3 kg

The above stated mattress specifications assist in ensuring the product conforms to HBSW and IEC specifications.

ENVIRONMENTAL CONDITIONS

Environmental Conditions	Operation	Storage and Transportation
Ambient Temperature		
Relative Humidity (Non-Condensing)		
Atmospheric Pressure		

Stryker reserves the right to change specifications without notice.

Specifications listed are approximate and may vary slightly from unit to unit or by power supply fluctuations.

Introduction

PRODUCT ILLUSTRATION

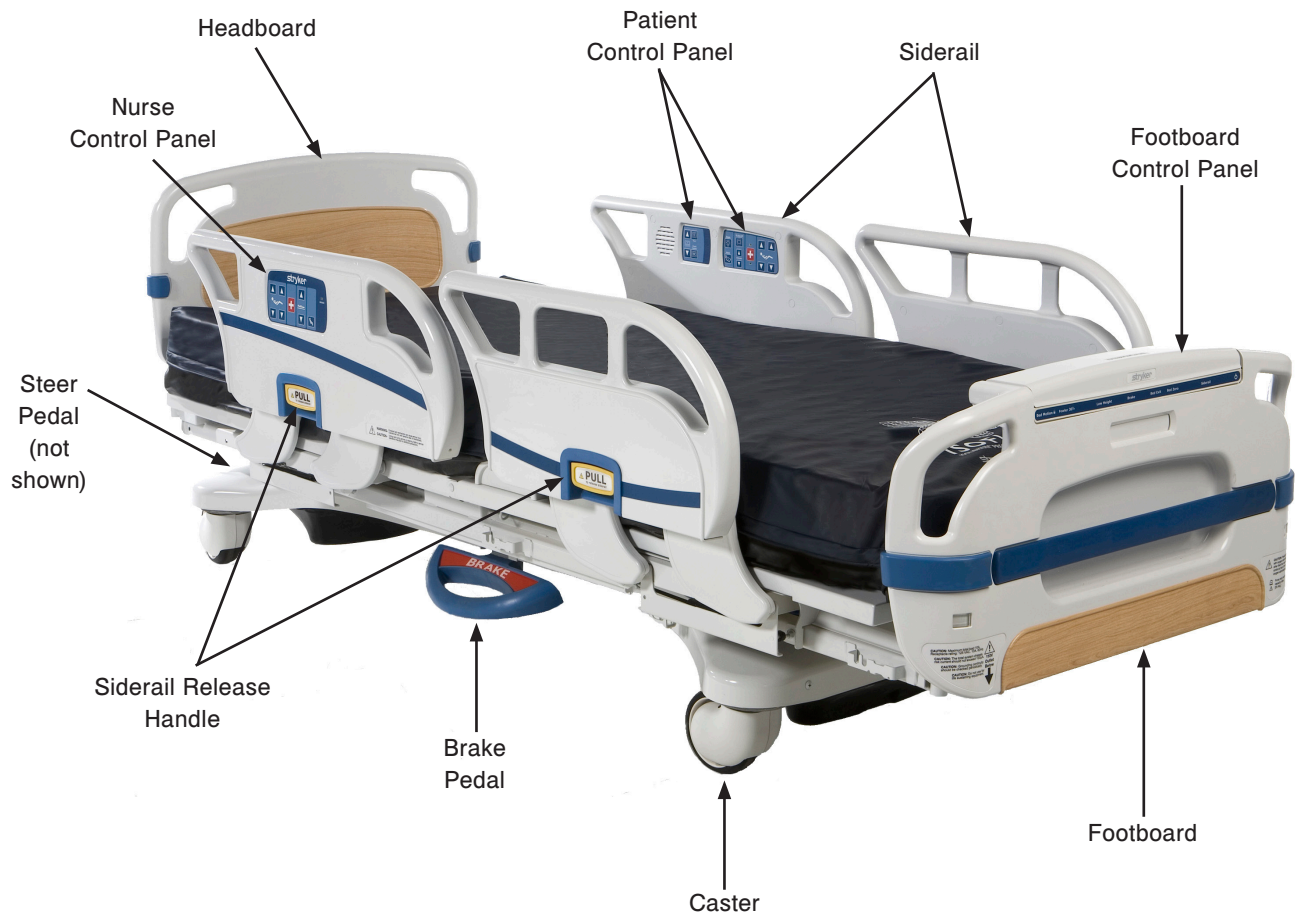

Introduction

CONTACT INFORMATION

Contact Stryker Customer Service or Technical Support at 1-800-327-0770.

Stryker Medical
3800 E. Centre Avenue
Portage, Michigan 49002
USA

Please have the serial number (A) of your Stryker product available when calling Stryker Customer Service or Technical Support. Include the serial number in all written communication.

SERIAL NUMBER LOCATION

The serial number is located at the head end of the bed just below the headboard and above the power cord where it comes out from the frame.

Head End of Bed



A

stryker®		⚠ IPX4	♂	CLASSIFIED c UL US
REF	3002 S3			87VL
SN	Serial No.			MEDICAL
	Date of Mfg.			ELECTRICAL
	115V~ 60 Hz, 8A			EQUIPMENT
	500 lbs. [227 Kg.]			UL 2601-1
WARNING: Does not tolerate machine washing or jet wash!				
Portage, MI 49002				Made in U.S.A.
This product is protected by the following U.S. patents, and other patents pending:				
US 5172442	US 5276432	US 5329657	US 5343581	

Summary of Safety Precautions

Carefully read and strictly follow the warnings and cautions listed on this page. Service only by qualified personnel.

WARNING

- Improper usage of the product can cause injury to the patient or operator. Operate the product only as described in this manual.
- Do not modify the product or any components of the product. Modifying the product can cause unpredictable operation resulting in injury to patient or operator. Modifying the product also voids its warranty.
- Always operate the product when all operators are clear of the mechanisms.
- Always allow the product to reach room temperature before conducting any setup or testing functional operations to prevent permanent product damage.
- Danger: Explosion hazard. Do not use in the presence of flammable anesthetics.
- Always apply the brakes when a patient is getting in the product or out of the product to avoid instability.
- Always apply the brakes when the patient is unattended.
- Always make sure that the brakes are completely released prior to moving the product. Attempting to move the unit with the brakes actuated could result in injury to the user and/or patient.
- Do not attempt to move the product laterally after you apply the steer lock pedal. The product cannot swivel when transporting with steer lock.
- Always make sure that all persons and equipment are away from the area below and around the fowler before you activate the CPR release. The CPR release is for emergency use only.
- Always lock the siderails in the full up position with the sleep surface horizontal in the lowest position when the patient is unattended.
- Always lock the siderails in the full up position with the sleep surface horizontal in the lowest position when transferring a patient.
- Always lock the siderails unless a patient's condition requires extra safety measures.
- Do not use the intermediate position in place of the highest position.
- Always use a Stryker supplied interface cable. Use of any other cable may cause the bed to function improperly, which may result in patient or user injury.
- Always plug the product directly into a properly grounded, three-prong receptacle. You can only achieve grounding reliability when you use a hospital-grade receptacle. This product is equipped with a hospital-grade plug for protection against electric shock hazard.
- Only use equipment with the following electrical specs: 110 VAC; 10A; 60Hz. Maximum total load drawn by equipment used in this receptacle outlet must not exceed 10A. The total system chassis risk current should not exceed 300 microamps. Grounding continuity should be checked periodically.
- Do not use the optional 110V outlet for life sustaining equipment.
- Do not route cords between a support surface and the product.
- Do not attach power cords to any moving part of the product.
- Do not use siderails as restraint devices to keep the patient from exiting the product. The design of the siderails keep the patient from rolling off the product. The operator must determine the degree of restraint necessary to make sure that the patient is safe. Failure to use the siderails as intended could result in serious patient injury.
- Do not use Bed exit (optional) to replace patient monitoring protocol.
- Do not use iBed Awareness (optional) as a lock indicator for siderails.
- Do not use iBed Awareness (optional) to replace patient monitoring protocol.
- Do not use the iBed Awareness LED light bars (optional) to replace patient monitoring protocol.
- Always make sure that the siderails are locked before you arm iBed Awareness.
- Do not turn off the iBed Awareness alarm. You will lose access to the event manager that displays the compromised parameter condition.
- Always unplug the bed power cord from the wall socket and push the battery power on/off switch to the "OFF" position (if applicable) before servicing or cleaning the bed. When working under a bed in the high position, always place blocks under the litter frame and apply the brakes to prevent injury in case the Bed Down switch is accidentally pressed.
- Always unplug all power cords before opening the service compartment, junction box, or receptacle to avoid the risk of electrical shock.
- Always secure the foot prop during cleaning or servicing.
- Always place the IV pole in the upright position before using the drive handle to avoid pinching your fingers.

[Return To Table of Contents](#)

Summary of Safety Precautions



WARNING (CONTINUED)

- Always use extra supervision when using a mattress or support surface thicker than six in. (15,4 cm).
 - When a patient's condition (such as disorientation due to medication or clinical condition) could lead to patient entrapment, the mattress support platform should be left in the flat position while the patient is unattended (except when required otherwise by medical staff for special or particular circumstances).
 - Trendelenburg is not easily achievable when mains voltage has been interrupted.
 - Medical electrical equipment (i.e. Optional Scale System) requires special precautions regarding EMC and needs to be installed and put into service according to the EMC information to prevent equipment malfunction.
 - Do not use the scale system readings as the only reference for medical treatment.
 - Portable and mobile RF communication equipment can affect Medical Electrical Equipment (i.e. Optional Scale System).
 - To avoid malfunction, the scale system (optional) should not be used adjacent to or stacked with other equipment. If adjacent or stacked use is necessary, the Optional Scale System should be observed to verify normal operation in the configuration in which it will be used.
 - Confirm proper scale system operation following mattress installation. For best results, secure the therapy mattress power cord to prevent damage to the cord or interference with the bed frame and the scale system.
 - Do not set the scale to zero when support surface therapies are active. The motion from the support surface therapies may adversely affect bed exit system performance.
 - Do not arm bed exit when support surface therapies are active. The motion from the support surface therapies may adversely affect bed exit system performance.
 - Always determine the proper use of the restraint straps and restraint strap locations. Improperly adjusted restraint straps can cause serious injury to a patient. Stryker is not responsible for the type or use of restraint straps on any of Stryker's products.
-



CAUTION

- Power save mode activates after one hour on battery power with no motion release switch activation. Bed exit, scale, and product motion stops operating when the product enters the power save mode.
 - Always raise the siderails when you lower the litter to its lowest position to prevent interference with the scale system.
 - Always make sure that you set the desired product parameters before you enable iBed Awareness.
 - Do not use accessories that cover the footboard and outside siderail LED light bars.
 - Do not use accessories that cover the control panels or mechanical parts of the product.
 - Do not turn off the iBed Awareness alarm. You will lose access to the event manager that displays the compromised parameter condition.
 - Always unplug the power cord during service or cleaning.
 - When large spills occur in the area of the circuit boards, 120 volt cables and motors, immediately unplug the bed power cord from the wall socket. Remove the patient from the bed and clean up the fluid. Have maintenance completely check the bed. Fluids can affect the operational capabilities of any electrical product. DO NOT put the bed back into service until it is completely dry and has been thoroughly tested for safe operation.
 - Preventative maintenance should be performed at a minimum of annually to ensure all bed features are functioning properly. Close attention should be given to safety features including, but not limited to, safety side latching mechanisms, frayed electrical cords and components, all electrical controls returning to the off or neutral position when released, caster braking systems, no controls or cabling entangled in bed mechanisms, leakage current 300 μ A (microamps) maximum, scale and bed exit systems calibrated properly, and the siderail gas spring not leaking oil.
 - Do not move footboards from one product to another. Individual products may have different options. Mixing footboards could result in unpredictable operation of the product.
 - The lockout buttons on the footboard lock the Fowler, Gatch and Bed Up/Down functions and prevent motion of the bed. It is the responsibility of attending medical personnel to determine whether these functions should be locked and to use the buttons accordingly.
 - The maximum safe working load for each IV pole is 40 pounds.
 - Do not use IV poles push/pull device.
-

Summary of Safety Precautions

CAUTION (CONTINUED)

- Scale function may be affected by siderail/caster interference. With the litter fully lowered or lowered in Reverse Trendelenburg, the siderails tucked under the litter in the storage position and the casters turned, there is the potential for interference between the siderail and the caster. Raise the siderails when lowering the litter to the full down position to prevent the interference from causing the scale system to weigh inaccurately
 - The use of a mattress overlay may reduce the effectiveness of the siderail.
 - The cleanliness and integrity of both ground chains must be maintained to minimize static build up and discharge.
 - Do not add or remove weight when the bed exit system is armed.
 - There is a possible fire hazard when using half bed length type oxygen administering equipment. Ensure the siderails are outside of the tent.
 - There is a possible fire hazard when used with oxygen administering equipment of other than the nasal or mask type. Lock the control at foot of bed when using oxygen administering equipment.
 - The weight of the foley bags placed on isolated bag hooks should not exceed five pounds.
 - The weight of pumps placed on footboard pump holder should not exceed 45 pounds.
 - The safe working load of the defibrillator tray is 40 lb.
 - The safe working load of the oxygen holder is 45 lb.
-

ZOOM® OPTION

In addition to the previous warnings and cautions, all of the following warnings and cautions apply to units equipped with the Zoom® option.

WARNING

- USE CAUTION while maneuvering the unit with the drive wheel activated. Always ensure there are no obstacles near the unit while the drive wheel is activated. Injury to the patient, user or bystanders or damage to the frame or surrounding equipment could occur if the unit collides with an obstacle.
 - Use caution when transporting the unit down hallways, through doors, in and out of elevators, etc. Damage to the siderails or other parts of the unit could occur if the unit comes in contact with walls or door frames.
 - Put the drive wheel in the neutral position and release the brakes before pushing the unit manually. Do not attempt to push the unit manually with the drive wheel engaged. The unit will be difficult to push and injury could result.
 - If unanticipated motion occurs, unplug the power cord from the wall socket, push the battery power on/off switch to the "OFF" position (the LED will not be illuminated) and actuate the drive wheel pedal to the neutral position.
 - The power save mode is activated after one hour on battery power with no motion switch activation. Functions including Bed Exit, Scale, iBed® Awareness and Motion will cease to operate when the unit enters the power save mode. Injury to the patient could occur if proper patient monitoring protocol is not observed.
 - Due to the weight the battery adds to the bed (approximately 50 pounds), additional force is required to move the bed. Caution should be used when transporting the bed. Additional assistance should be used when necessary. Failure to use caution while transporting the bed may result in injury to the user.
 - Battery posts, terminals and related accessories contain lead and lead compounds, chemicals known to the State of California to cause cancer and birth defects or other reproductive harm. Wash hands after handling.
-

CAUTION

- To avoid damage while transporting the bed, verify the IV pole is at a low enough height to allow it to safely pass through door openings and under light fixtures.
 - The battery tray assembly weighs 50 pounds. Take care when removing the two hex head screws securing it to the base frame or personal injury could result.
-

Summary of Safety Precautions

iBED® WIRELESS OPTION

In addition to the previous warnings and cautions, all of the following warnings and cautions apply to units equipped with the *iBed*® Wireless option.

WARNING

- The optional *iBed*® Wireless function provides remote information of bedside information to aid the caregiver. In no way does this option replace the caregiver's responsibility of checking on patients. Caregivers should not rely **only** on the remote information to perform their duties.
- The *iBed* Locator must be correctly associated or mapped to the room / location in order to provide accurate location information. Failure to properly map the *iBed* Locator to the room / location will yield incorrect remote information. Additionally, if an *iBed* Locator is to be moved after it has been installed and mapped, it must be re-mapped to the new room / location in which it is moved to. *iBed* Locator re-mapping will also be required if the room / location information is changed after initial installation.
- Line of sight between *iBed* Locator and the head end of bed must be free of obstruction at all times. Any line of sight interference could impede communication and cause the room / location information not to be available.
- *iBed*® Wireless compatible footboard must be used for all *iBed*® Wireless beds. Some *iBed*® Wireless functionality will be lost if an older version of the footboard is used.
- *iBed*® Wireless functionality shall be verified after installation. Failure to do so may result in loss of remote information or wrong remote information. At a minimum, verify *iBed* locator communication with bed in all bed positions, and *iBed*® Wireless communication with the wireless access point.
- *iBed* Locators must be installed more than 71" apart from one another in the same room, such as in a semi-private room with more than one bed. Failure to do so could result in a bed communicating with the other adjacent *iBed* Locator, thus providing incorrect bed location information.

CAUTION

Wireless bed only transmits bed information and not nurse call information. The wireless bed is not intended to replace the existing nurse call system.

Setup

It is important that the product works properly before you put it into service. The following list will help ensure that each part of the bed is tested.

WARNING

- Always plug the product directly into a properly grounded, three-prong receptacle. You can only achieve grounding reliability when you use a hospital-grade receptacle. This product is equipped with a hospital-grade plug for protection against electric shock hazard.
- Always use a Stryker supplied interface cable. Use of any other cable may cause the bed to function improperly, which may result in patient or user injury.

-
1. Plug the bed into a properly grounded, hospital grade wall receptacle and ensure the  LED light at the foot end of the bed comes on.
 2. Plug the optional interface cable into the 37-pin connector under the litter frame at the head end of the bed, into the “Patient Station”, “Head Wall”, “Docking Station” or equivalent (whichever applies). Test the interface cable to verify it is functioning properly.
 3. Ensure the siderails raise, lower, lock in the up position, lock in the intermediate position when lowered and store smoothly ([see page 21](#)).
 4. Ensure that all four casters lock when the brake pedal is engaged ([see page 19](#)).
 5. Raise the fowler (head of bed) up to approximately 60°. Squeeze the CPR release handle and ensure the back will drop with minimal effort.

Note

Ensure that the “Brake” LED located on the outside of the head end siderails and on the footboard control panel blink when the brakes are not engaged.

6. Perform each function on the footboard control panel to ensure that each function is working properly ([see page 29](#)).
7. Perform each function on both head end siderails to ensure that each is working properly ([see page 21](#)).
8. Activate the motion stop system to ensure it is functioning properly; press the BED DOWN button to lower the bed. As the bed lowers, push up on the motion interrupt pan under the bed and ensure the downward motion stops. Release the pan and allow the downward motion to continue.

Note

The bed’s upward motion or other functions are not disrupted by the motion stop system.

9. If the bed is equipped with the Nurse Call option, verify it is functioning properly prior to patient use.

Setup

ZOOM® OPTION

If your bed is equipped with the Zoom® drive wheel option, run through the setup procedures on [see page 17](#) and continue with the procedures listed below.

- Plug the power cord into a properly grounded, hospital grade wall receptacle. The 12 volt batteries that provide power to the drive wheel and backup power to the unit functions will charge whenever the power cord is plugged into the wall socket. The batteries require approximately 10 hours of charging time before the bed is put into service.
- Unplug the power cord from the wall socket. Push the battery power switch located on the lower left corner of the head end to the “ON” position. Again, verify each function on the footboard and siderails is operating properly.
- With the battery power switch in the “ON” position and the brakes engaged, ensure the “Release Brakes” LED on the head end control panel is illuminated.
- With the battery power switch in the “ON” position and the drive wheel in the neutral position (not touching the floor), ensure the “Engage Drive Wheel” LED on the head end control panel is illuminated.
- Perform the operation of the drive wheel to ensure it is operating properly ([see page 48](#)).

If any problems are found during bed setup, contact Stryker Customer Service at (800) 327–0770.

iBED® WIRELESS OPTION

In order for your bed to be capable of receiving a wireless connection the *i*Bed Locator needs to be installed on the wall at the head end of the bed. The *i*Bed Locator communicates with the IR Module installed in your bed. For detailed instructions on mounting the 5212 *i*Bed Locator refer to the instruction sheet (part number 5212-009-101) packaged with your optional 5212 *i*Bed Locator Installation kit.

If any problems are found during the *i*Bed Locator Installation, contact Stryker Technical Support at (800) 327–0770.

WARNING

The *i*Bed Locator must be correctly associated or mapped to the room / location in order to provide accurate location information. Failure to properly map the *i*Bed Locator to the room / location will yield incorrect remote information. Additionally, if an *i*Bed Locator is to be moved after it has been installed and mapped, it must be re-mapped to the new room / location in which it is moved to. *i*Bed Locator re-mapping will also be required if the room / location information is changed after initial installation.

The wireless connection settings need to be loaded before the device will communicate with the *i*Bed Server application. Reference the ***i*Bed Server Installation and Configuration Manual** (5212-009-001).

Note

*i*Bed® Wireless will not send *i*Bed Locator information unless the brake is set (Battery Backup and Zoom® options only).

Operation

BRAKE PEDAL OPERATION

WARNING

Always apply the caster brakes when a patient is getting on or off the bed. Push the bed sideways to ensure the brakes are securely locked. Always engage the brakes unless the bed is being moved. Injury could result if the bed moves while a patient is getting on or off the bed.

To activate the brakes, push down once on one of the pedals located at the midpoint of the bed on both sides (identified by the label at right). The pedal will remain in the lowered position, indicating the brakes are engaged. To disengage the brakes, push down once and the pedal will return to the upper position.



Note

The LED lights located on the outside of the head end siderails and on the foot end control panel will blink when the brakes are not engaged only if the bed is plugged into a wall socket or is running on battery power (see page 24 & page 31). The brakes will still operate properly when the bed is not plugged in.

STEER PEDAL OPERATION (BEDS WITHOUT THE ZOOM® DRIVE WHEEL OPTION)

When the bed is moved, the steer caster helps guide the bed along a straight line and helps the bed pivot around corners.

To activate the steer caster, move the pedal located at the head end of the bed to your right as shown on the label.



Note

For proper “tracking” of the steer caster, push the bed approximately 10 feet to allow the wheels to face the direction of travel before engaging the steer pedal. If this is not done, proper “tracking” will not occur and the bed will be difficult to steer.

WARNING

Do not attempt to move the foot end of the bed laterally when the steer pedal is activated. When the steer pedal is activated, the steer caster at the foot end of the bed cannot swivel. Attempting to move the bed laterally when the steer pedal is activated may cause injury to the user.

CPR EMERGENCY RELEASE

When quick access to the patient is needed, and the Fowler (head of bed) is raised, squeeze one of the two release handles (marked by the red CPR label) and the fowler can quickly be guided down to a flat position.

Operation

FOOT PROP USAGE

The foot prop causes the foot end of the Knee Gatch to rise when the Gatch button is used to raise the Gatch. To lower the foot end of the Gatch, release the prop by grasping the end of the Knee Gatch, lifting upward and swinging the prop (A) toward the head end of the bed which will disengage the prop stop.

WARNING

Always secure the foot prop during cleaning or servicing.

FRACTURE FRAME USAGE

A standard fracture frame can be mounted on the bed using the I.V. sockets located on all four corners of the bed. I.V. poles can be used in conjunction with a fracture frame if the I.V. pole adaptor sockets are purchased.

WARNING

Use only retractable traction or fracture frames. Failure to use a retractable frame may result in injury to the patient and/or damage to the equipment.

FOLEY BAG HOOKS USAGE

The standard foley bag hooks are found at four locations (on each side of the bed); below the seat (middle) section and at the extreme foot end of the frame. Optional isolated foley bag hooks can be purchased and are located at the foot end of the bed under the frame. The patient weight reading on the scale system is not affected when the optional isolated foley bag hooks are used.

PATIENT RESTRAINT STRAP LOCATIONS

The bed has 10 locations for installing patient restraint straps on the litter top, five on each side of the bed.

WARNING

Always determine the proper use of the restraint straps and restraint strap locations. Improperly adjusted restraint straps can cause serious injury to a patient. Stryker is not responsible for the type or use of restraint straps on any of Stryker's products.

NIGHT LIGHT USAGE

The bed is equipped with two night lights to illuminate the floor area around the bed. There is a switch under the litter thigh section on the patient's left side that turns both lights on and off.

WARNING

Service only by qualified personnel. Refer to the maintenance manual. Verify the power cord is unplugged before servicing.

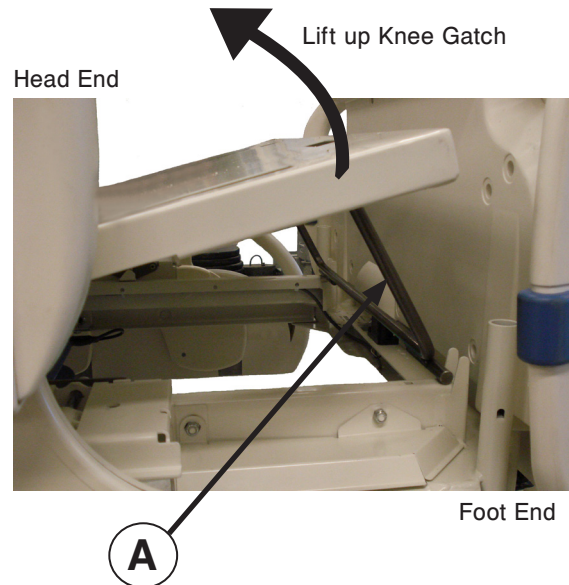

Operation

POSITIONING SIDERAILS

- The siderails can be locked at two heights (intermediate & full up).
- The siderails can slide in towards the bed when not in use. To remove the rail from the tucked position, grasp the top of the rail and pull outward.
- To raise head end siderail to full height position, grasp the rail and swing it upward until it locks in place (two clicks are heard).

Note: When the siderail is being raised, it does not lock in the intermediate position unless it is brought back after the first click.

- To lower the siderail and lock in intermediate position, pull outward on the siderail release handle (A) and rotate the siderail down toward the head end of the bed until it locks at the intermediate position.
- To lower the siderail in its full down position, pull outward on the release handle (A) and rotate the siderail downward toward the head end of the bed until it is completely lowered.
- To raise and lower the foot end siderail, the same procedures are required as for the head end siderail, however, the siderail swings toward the foot end of the bed.

WARNING

- Do not use siderails as restraint devices to keep the patient from exiting the product. The design of the siderails keep the patient from rolling off the product. The operator must determine the degree of restraint necessary to make sure that the patient is safe. Failure to use the siderails as intended could result in serious patient injury.
- Always lock the siderails in the full up position with the sleep surface horizontal in the lowest position when the patient is unattended.
- Always lock the siderails in the full up position with the sleep surface horizontal in the lowest position when transferring a patient.
- Always lock the siderails unless a patient's condition requires extra safety measures.

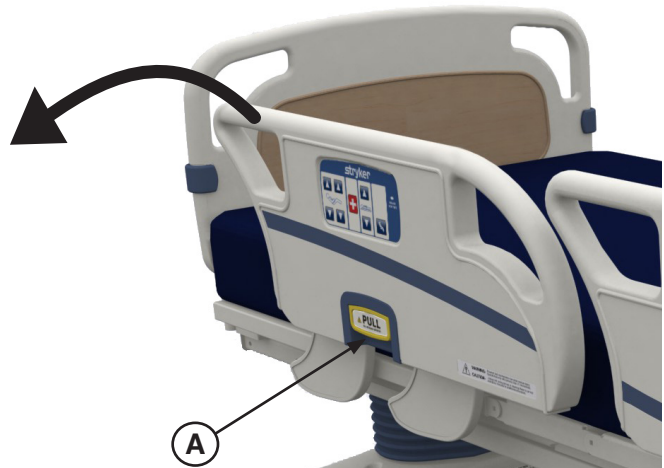

To disengage the rail, pull outward on release handle (A) and swing the rail down to the desired height (intermediate or full down). When storing siderails, ensure they are at a full down position.

CONTROL PANEL LIGHTS

The bed is equipped with lights to illuminate the head end siderail control panel and the red nurse call switches. Both can be activated at the footboard control panel. Five settings are available for the control panel lights: Off, Low Intensity, Medium Intensity, High Intensity and Nurse Call Only.

To change the control panel light settings, press the "Menu" button on the footboard. Scroll down through the menu items and select "Backlight" then press "Enter". Select the desired setting by highlighting it and then pressing "Enter".

Operation

OPERATING IV POLES

WARNING

Always place the IV pole in the upright position before using the drive handle to avoid pinching your fingers.

To use the Removable IV pole:

1. Install the pole at any of the four receptacles on the bed top (located on all four corners of the frame).
2. To raise the height of the pole, turn knob (A) counterclockwise and pull up on the telescoping portion (B) of the pole and raise it to the desired height.
3. Turn knob (A) clockwise to tighten the telescoping portion in place.

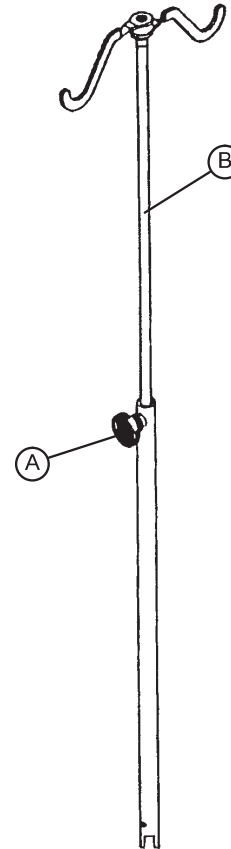

CAUTION

The maximum safe working load for each IV pole is 40 pounds.

To use the 2-Stage Permanently Attached IV pole:

Note

The 2-stage permanently attached IV pole is an option and may have been installed at either the head, foot or both ends of the bed. The choice was made at the time the unit was purchased.

1. Lift and pivot the pole from the storage position and push down until it rests in the receptacle.
2. To raise the height of the pole, pull up on the telescoping portion (A) until it locks into place at its fully raised position.
3. Rotate the IV hangers (B) to desired position and hang IV bags.
4. To lower the IV pole turn the latch (C) clockwise until section (A) lowers.

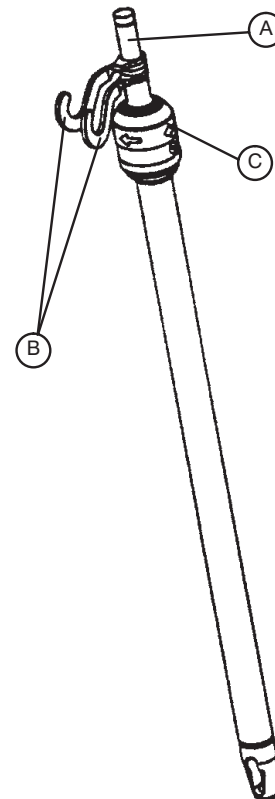

CAUTION

The maximum safe working load for each IV pole is 40 pounds.

Operation

NURSE CALL BACKUP BATTERY (OPTIONAL)

- To prevent a low battery condition when the bed is not plugged in, position the cord out switch at the head end of the bed to the off position. The switch is identified by the label shown below. If the switch is not positioned as shown below and the bed power cord and pendant cord are unplugged, the life of the backup battery will be significantly reduced.
- If the Nurse Call battery needs to be replaced, a message will appear on the footboard display. The battery is located on the patient's left side at the head end of the bed. No tools are required to replace the battery. Unplug the bed power cord from the wall socket and remove the battery from its housing to replace.

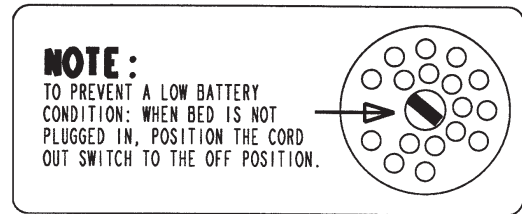

1/4 IN NURSE CALL PORT (OPTIONAL)

- The optional 1/4 in nurse call port is only designed to function with nurse call cords that have a 1/4 in TS connector.
- Fully insert the attached dummy plug into the port whenever a nurse call cord is not inserted into the port.
- If a continuous nurse call signal is observed, ensure that the dummy plug or a compatible nurse call cord is fully inserted into the port.

WARNING

- Only use equipment with the following electrical specs: 110 VAC; 10A; 60Hz. Maximum total load drawn by equipment used in this receptacle outlet must not exceed 10A. The total system chassis risk current should not exceed 300 microamps. Grounding continuity should be checked periodically.
 - Always unplug all power cords before opening the service compartment, junction box, or receptacle to avoid the risk of electrical shock.
-

USING THE 110 VOLT OUTLET (OPTIONAL)

- The 110V outlet has its own power cord that must be plugged into a properly grounded hospital grade three prong wall receptacle different from the wall receptacle the bed power cord is plugged into.
 - If the equipment plugged into the bed outlet is not receiving power, check the 10A circuit breakers located on the litter frame under the head section. Reset, if necessary.
-

WARNING

- Only use equipment with the following electrical specs: 110 VAC; 10A; 60Hz. Maximum total load drawn by equipment used in this receptacle outlet must not exceed 10A. The total system chassis risk current should not exceed 300 microamps. Grounding continuity should be checked periodically.
 - Do not use the optional 110V outlet for life sustaining equipment.
 - Do not route cords between a support surface and the product.
 - Do not attach power cords to any moving part of the product.
 - Always unplug all power cords before opening the service compartment, junction box, or receptacle to avoid the risk of electrical shock.
-

Operation

NURSE CONTROL FUNCTIONS (OUTSIDE SIDERAIL)

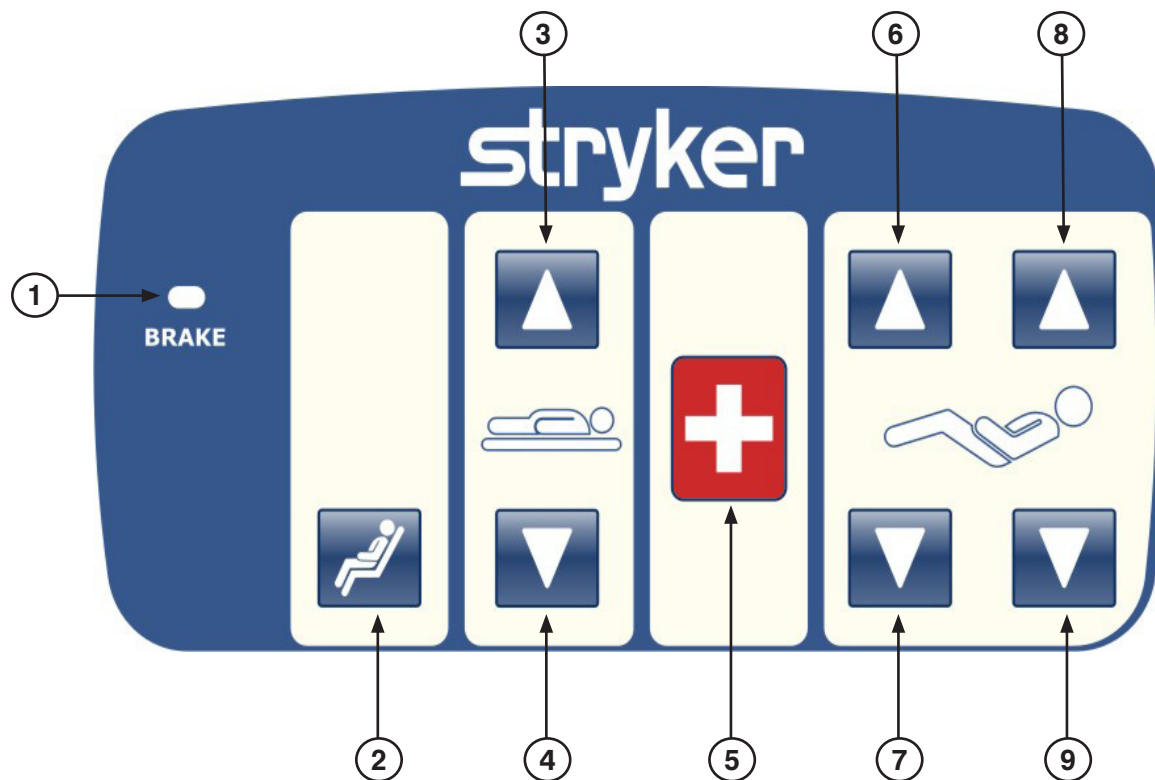

LEFT OUTER SIDERAIL SHOWN
(Right Outer Siderail same as the Left)

Button	Button Name	Button Function
1	Brake LED	LED flashes when Brakes are not engaged. LED is "Off" when brakes are engaged.
2	Cardiac Chair	Press to activate the Cardiac Chair function. <ul style="list-style-type: none"> The Knee will raise. The back will raise to approximately 60° The bed will tilt to approximately -10° reverse Trendelenburg (foot end down).
3	Bed/Litter Up	Press to raise the Bed/Litter.
4	Bed/Litter Down	Press to lower the Bed/Litter.
5	Nurse Call	Push to activate Nurse Call.
6	Knee Gatch Up	Press to raise the Knee Gatch.
7	Knee Gatch Down	Press to lower the Knee Gatch.
8	Fowler Up	Press to raise the Fowler.
9	Fowler Down	Press to lower the Fowler.

Note: The intent of the nurse call light on the siderails is to ensure the patient immediately knows which button to push to contact the nurse station. Turning the light off may compromise this ability, especially in a darkened room.

Operation

PATIENT CONTROL FUNCTIONS WITHOUT OPTIONAL SMART TV (INSIDE SIDERAIL)

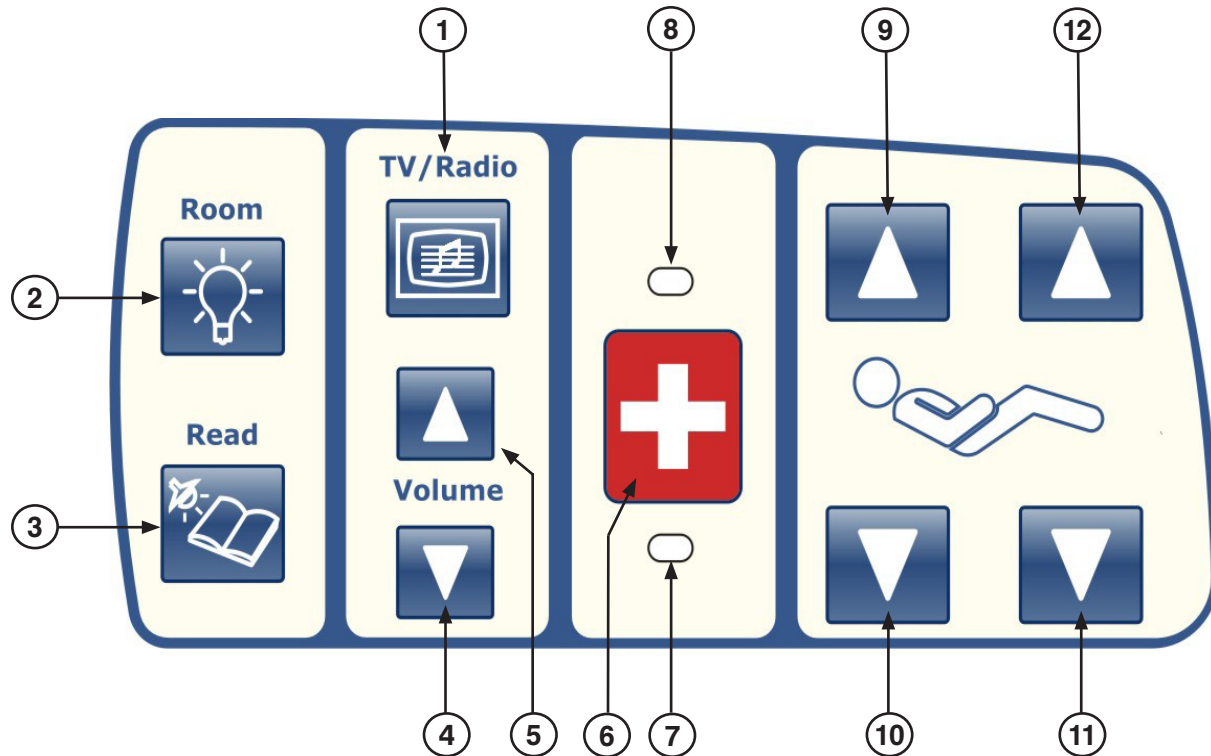

LEFT INSIDE SIDERAIL SHOWN

(Right Inside Siderail same as the Left with exception of the Nurse Call and Nurse Answer LED. LED 7 and 8 will change positions on the right inner siderail)

Button	Button Name	Button Function
1	TV On/Off	Press to turn TV or radio on and to select a channel.
2	Room Light	Press to turn the room light On/Off.
3	Bed Overhead Light	Press to turn the bed overhead light On/Off.
4	TV/Radio Volume Down	Press to decrease volume; TV or Radio.
5	TV/Radio Volume Up	Press to increase volume; TV or Radio.
6	Nurse Call	Press to activate Nurse Call. Note: Amber LED will light when button is pushed. Green LED will light with Nurse Station acknowledgment.
7	Nurse Call LED	Illuminates amber when nurse call has been pressed by patient.
8	Nurse Call Answer LED	Illuminates green when answered by Nurse.
9	Fowler Up	Press to raise the Fowler.
10	Fowler Down	Press to lower the Fowler.
11	Knee Gatch Down	Press to lower the Knee Gatch.
12	Knee Gatch Up	Press to raise the Knee Gatch.

Operation

PATIENT CONTROL FUNCTIONS WITH OPTIONAL SMART TV (INSIDE SIDERAIL)

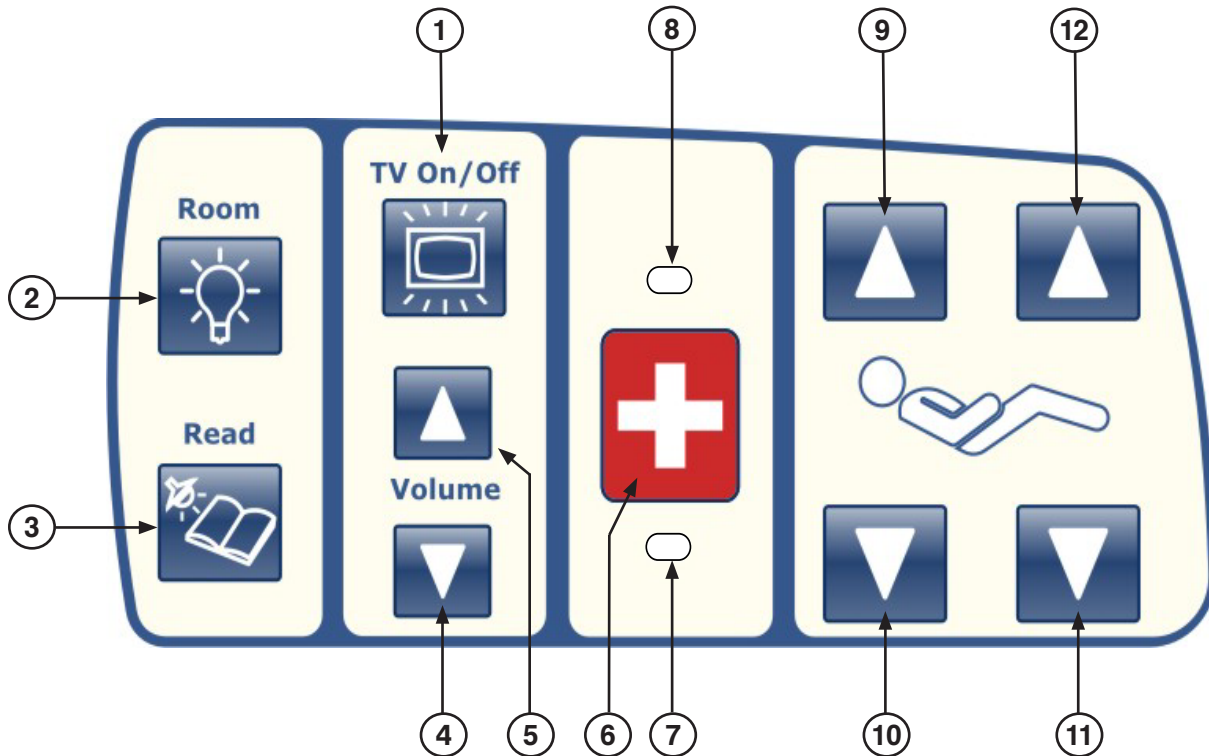

LEFT INSIDE SIDERAIL SHOWN
(Right Inside Siderail same as the Left)

Button	Button Name	Button Function
1	TV On/Off	Press to turn TV or radio on and to select a channel.
2	Room Light	Press to turn the room light On/Off.
3	Bed Overhead Light	Press to turn the bed overhead light On/Off.
4	TV/ Volume Down	Press to decrease TV volume.
5	TV/ Volume Up	Press to increase TV volume.
6	Nurse Call	Press to activate Nurse Call. Note: Amber LED will light when button is pushed. Green LED will light with Nurse Station acknowledgment.
7	Nurse Call LED	Illuminates amber when nurse call has been pressed by patient.
8	Nurse Call Answer LED	Illuminates green when answered by Nurse.
9	Fowler Up	Press to raise the Fowler.
10	Fowler Down	Press to lower the Fowler.
11	Knee Gatch Down	Press to lower the Knee Gatch.
12	Knee Gatch Up	Press to raise the Knee Gatch.

Operation

PATIENT TV CHANNEL CONTROL FUNCTIONS WITH OPTIONAL SMART TV (INSIDE SIDERAIL)

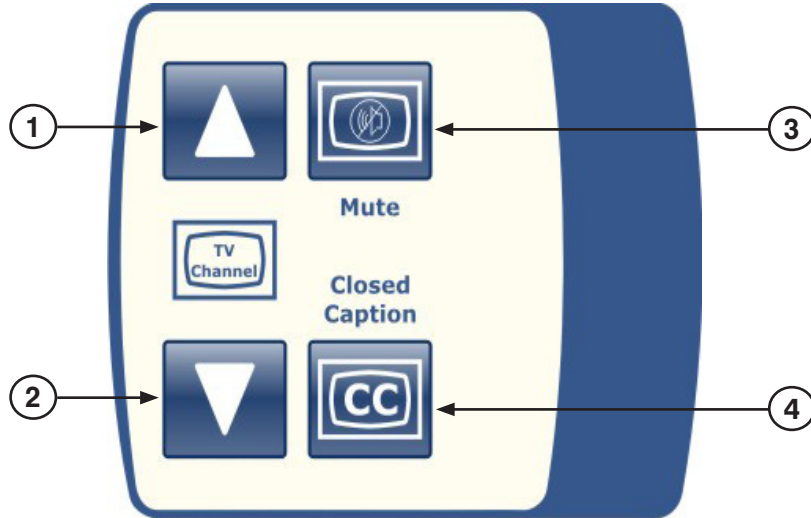

LEFT INSIDE SIDERAIL SHOWN
(Right Inside Siderail same as the Left)

Button	Button Name	Button Function
1	TV Channel Up	Press to change TV channel up.
2	TV Channel Down	Press to change TV channel down.
3	Mute TV	Press to mute TV volume. Press again to turn the sound back on.
4	Closed Caption	Press to display the closed captioning. Press again to turn off the closed captioning.

Operation

FOOTBOARD CONTROL PANEL

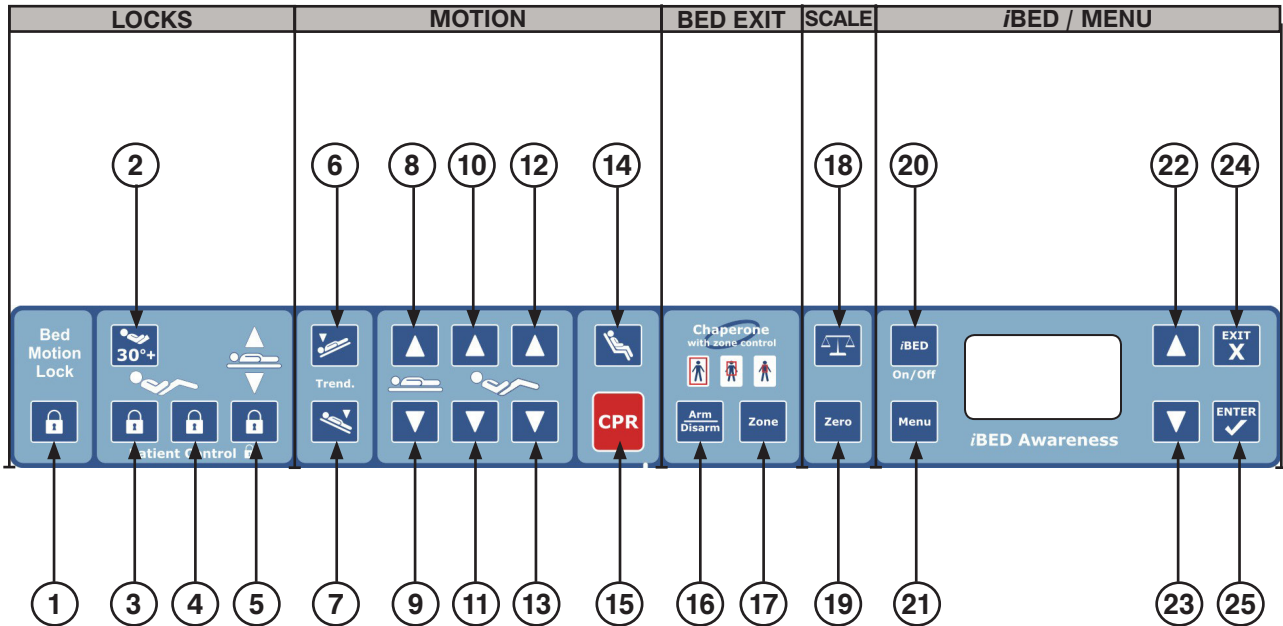

Button	Name	Button	Name	Button	Name
1	Bed Motion Lock	9	Bed/Litter Down	18	Scale
2	Fowler 30 ⁰ +	10	Fowler Up	19	Scale Zero
3	Patient Fowler Lock	11	Fowler Down	20	iBed On/Off
4	Patient Gatch Lock	12	Knee Gatch Up	21	Menu
5	Patient Bed Up/ Down Lock	13	Knee Gatch Down	22	Menu Up
6	Trend	14	Cardiac Chair	23	Menu Down
7	Reverse Trend	15	CPR Drop	24	Exit
8	Bed/Litter Up	16	Bed Exit Arm/Disarm	25	Enter
		17	Bed Exit Zone Control		

Operation

FOOTBOARD CONTROL PANEL (CONTINUED)

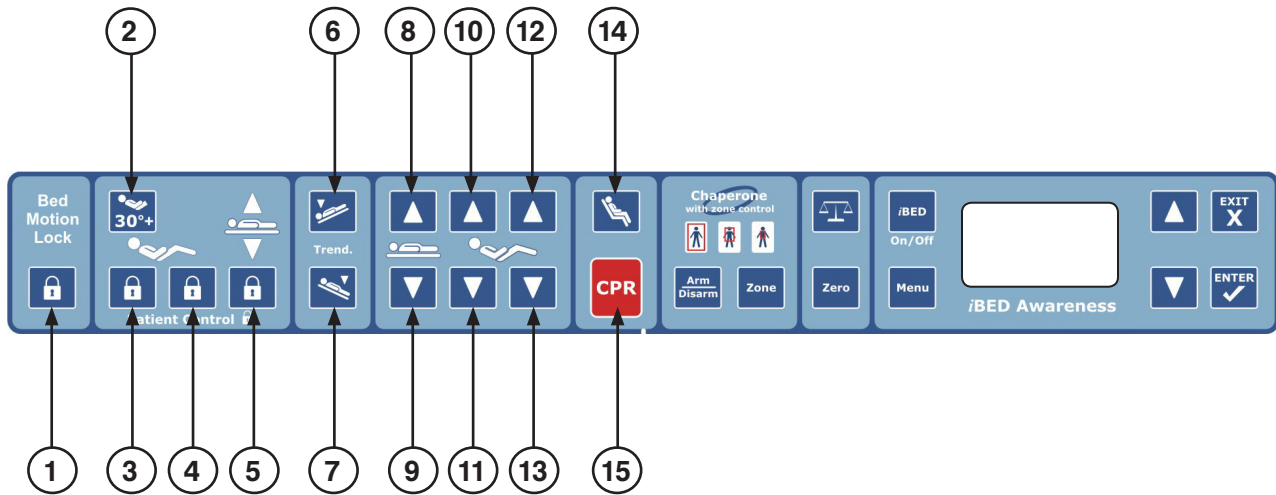

	Button	Name	Function
LOCKS	1	Bed Motion Lock	Locks all motion on bed. The Bed Motion Lock button will illuminate when activated.
	2	Fowler 30°+	Moves bed out of trend and raises the Fowler to 30°. The Fowler 30°+ button and dashboard light will illuminate when activated. Note: The Fowler will not go below 30° once the Fowler 30°+ lock is activated. However, it may be raised or lowered in the 30° to 60° range.
	3	Patient Fowler Lock	Locks out Fowler control at all locations (Siderail, Pendant, Head End) with the exception of the operator controls located on the Footboard. The Patient Fowler Lock button will illuminate when activated.
	4	Patient Gatch Lock	Locks out Gatch control at all locations (Siderail, Pendant, Head End). The Patient Gatch Lock button will illuminate when activated. This function also prevents the auto contour of the Gatch when motion is used. Note: Auto contour is the feature of the bed that when fowler is actuated, Gatch automatically moves with the Fowler.
	5	Patient Bed Up/Down Lock	Locks out Bed Height control at all locations (Siderail, Pendant, Head End) with the exception of the operator controls located on the Footboard. The Patient Bed Up/Down Lock button and Bed Motion dashboard light will illuminate when activated.
MOTION	6	Trendelenburg	Lowers head end and raises foot end of bed.
	7	Reverse Trendelenburg	Lowers foot end and raises head end of bed
	8	Bed/Litter Up	Raises Bed/Litter.
	9	Bed/Litter Down	Lowers Bed/Litter.
	10	Fowler Up	Raises Fowler.
	11	Fowler Down	Lowers Fowler.
	12	Knee Gatch Up	Raises Knee Gatch.
	13	Knee Gatch Down	Lowers Knee Gatch.
	14	Cardiac Chair	When activated, the knee will raise, the Fowler will raise or lower to approximately 60° degrees and the bed will tilt to approximately -10° Reverse Trendelenburg (foot end down).
	15	CPR Drop	Activates electronic CPR function; flattens litter and puts bed in low height.

Operation

FOOTBOARD CONTROL PANEL (CONTINUED)

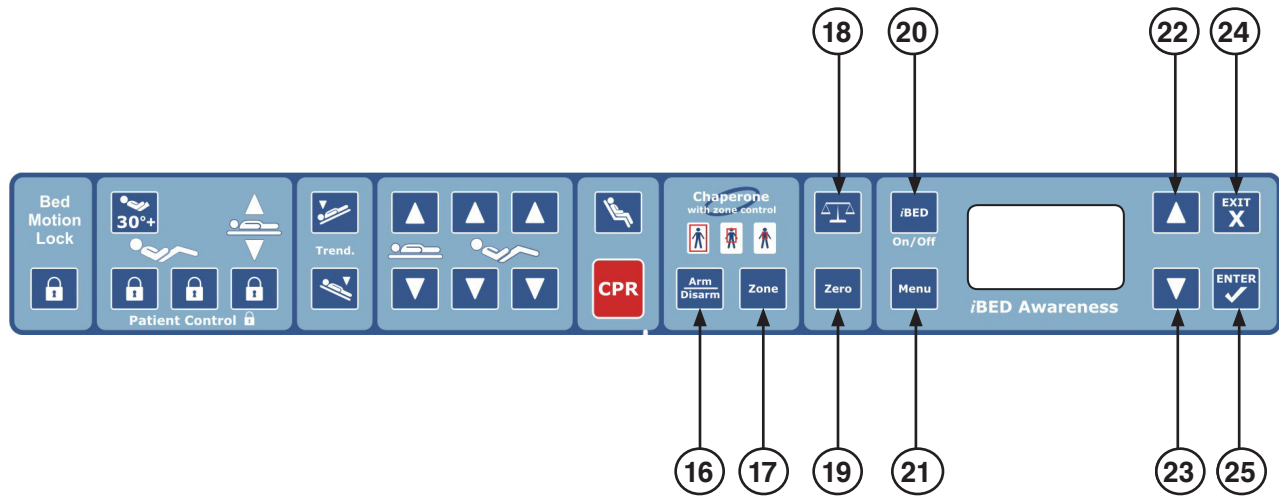

	Button	Name	Function
BED EXIT	16	Bed Exit Arm/Disarm	Activates Bed Exit system. The selected zone graphic will illuminate when activated. When Bed Exit is in alarm mode, press and hold "Arm/Disarm" to turn Bed Exit "Off".
	17	Zone Control	Changes the Zone.
SCALE	18	Scale	Displays scale information on screen.
	19	Zero	Zeroes Bed.
iBED/MENU	20	On/Off	Turns iBed® Awareness system ON/OFF.
	21	Menu	Accesses MENU selections.
	22	Menu Up	Scroll Up through menu.
	23	Menu Down	Scroll Down through menu.
	24	Exit	Exits or Escapes from menu selection; also used to Cancel operations.
	25	Enter	Selects menu item; also used to Save operations.

Operation

FOOTBOARD LED INDICATORS

The LED indicators on the footboard control panel illuminate when there is a parameter change on the product.

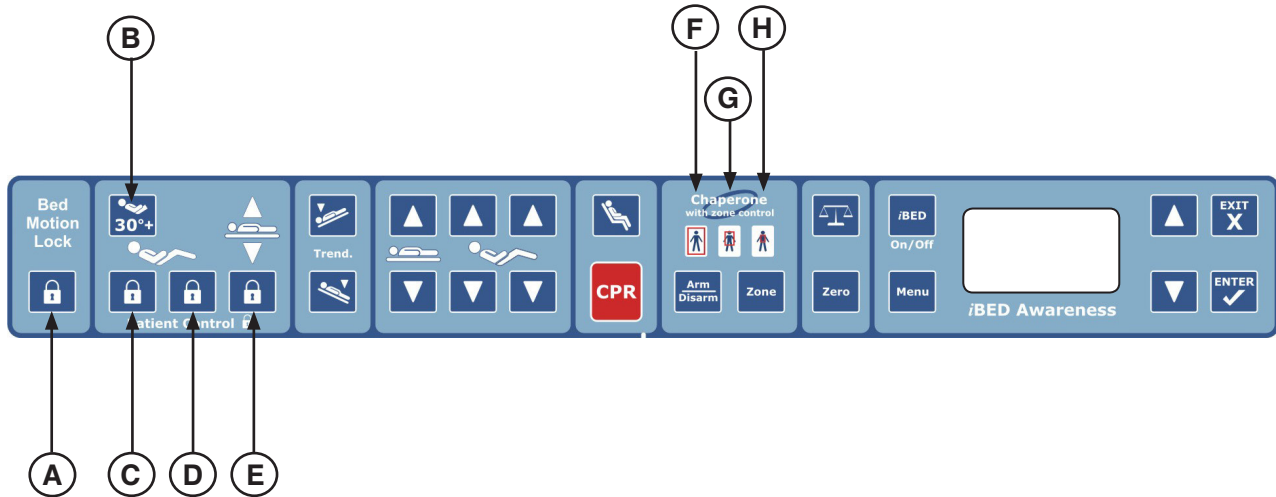

LED	Name: Function	LED Color
A	Bed Motion Lock LED: LED is illuminated if Bed Motion is locked; blinking if motion is attempted when lock is “On”.	AMBER
B	Fowler 30°+ Lock LED: LED is illuminated if Fowler 30°+ is locked; blinking if locked and Fowler motion is attempted while Fowler is at 30°; flashes if lock condition is violated by CPR.	AMBER
C	Patient Control Fowler Lock LED: LED is illuminated if the Patient Fowler Lock is “On”.	AMBER
D	Patient Control Gatch Lock LED: LED is illuminated if the Patient Gatch Lock is “On”.	AMBER
E	Patient Control Bed Up/Down Lock LED: LED is illuminated if the Patient Bed Up/Down Lock is “On”.	AMBER
F	Zone 1 LED: LED is illuminated when Bed Exit is “On” and Zone 1 activated; flashes if a Bed Exit event occurs.	AMBER
G	Zone 2 LED: LED is illuminated when Bed Exit is “On” and Zone 2 activated; flashes if a Bed Exit event occurs.	AMBER
H	Zone 3 LED: LED is illuminated when Bed Exit is “On” and Zone 3 activated; flashes if a Bed Exit event occurs.	AMBER

Operation

FOOTBOARD LED INDICATORS (CONTINUED)

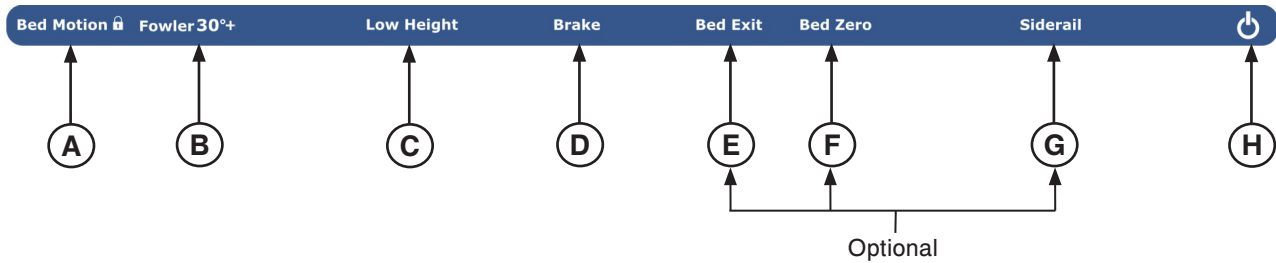

LED	Name: Function	LED Color
A	Bed Motion Lock LED: LED is illuminated when Bed Motion Lock is activated or when the Patient Control (Fowler, Gatch, Bed Up/Down) Lock buttons are activated.	AMBER
B	Fowler 30⁺ LED: LED is illuminated when the Fowler 30+ is locked. The LED will blink if the <i>iBed</i> [®] Awareness system is “On”, the Fowler 30+ is being monitored and the Fowler goes below 30 degrees or the Fowler 30+ is turned “Off”.	AMBER
C	Low Height LED: LED is illuminated when bed is in low height. The LED will blink if the <i>iBed</i> [®] Awareness system is “On”, the low height is being monitored, and the bed is not in low height.	AMBER
D	Brake LED: LED is illuminated when the brake is set, and will blink if the brake is not set.	AMBER
E	Bed Exit LED (Optional): LED is illuminated when the Bed Exit is armed. The LED will blink if the Bed Exit is turned Off while the <i>iBed</i> [®] Awareness system is turned On or if Bed Exit alarms while monitored by <i>iBed</i> [®] Awareness system.	AMBER
F	Bed Zero LED (Optional <i>iBed</i>[®] Awareness): LED is illuminated if Bed Zero is successful.	AMBER
G	Siderail LED (Optional <i>iBed</i>[®] Awareness): LED is illuminated if <i>iBed</i> [®] Awareness system is “On”. The LED will blink when siderail state has changed.	AMBER
H	Power LED: LED is illuminated when bed has power.	GREEN

Operation

DISPLAY SCREENS

There are four types of display screens listed by priority below with one being the highest.

Screen	Type	Priority
Alarm Indications	Bed Exit Alarm Message	1
	Brake Alarm Message	2
Messages	iBed® Awareness Alert Messages	3
	Conditional Message	4
Menus	Main Menu	5
Status Screen	Default Screen	6

A. Power Up

- The initialization screen shown in Figure 1 will be displayed on power up.

B. Status Screen (without iBed® Wireless option)

- Figure 2a shows an example of the default “Status” Screen.
- Information on this screen includes the ‘Fowler Angle’ and the ‘Trend Angle’ values.
- If this screen is inactive for 60 seconds, the Backlighting will be reduced.

C. Status Screen (with iBed® Wireless option)

- Figure 2b shows an example of the default “Status” Screen.
- Information on this screen includes the WiFi and iBed Locator connection status, ‘Fowler Angle’ and ‘Trend Angle’ values.
- If this screen is inactive for 60 seconds, the Backlighting will be reduced.



Figure 1

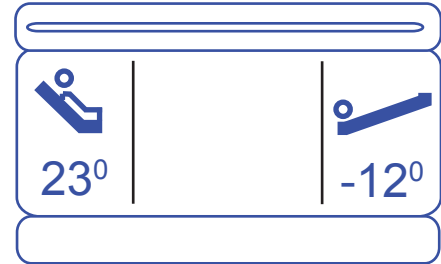

Figure 2a

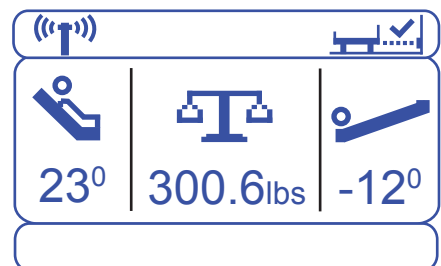

Figure 2b

Icons				
Wireless Connectivity Status	Not Connected; Trying to Connect	Connected		
Signal Strength Level	None	Low	Good	Excellent
Signal Strength, X	X < -90 dB or X = 0 dB	-90 dB ≤ X < -71 dB	-71 dB ≤ X < -57 dB	X ≥ -57 dB

D. Message Screen

- As required message screens are provided during alarm conditions and user interaction with the bed.

E. Main Menu

- The Menu screen provides of list of available features accessible to the operator.

Operation

CHAPERONE BED EXIT (OPTIONAL)

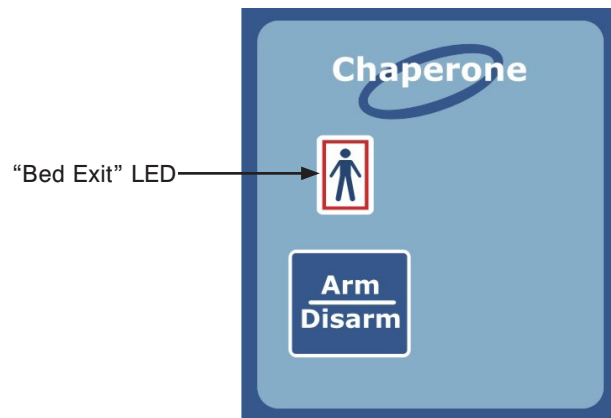

1. Before positioning the patient on the bed, the scale system must be zeroed for the Bed Exit System to function properly (see page 37 for instructions on zeroing the scale system).
2. Position the patient on the bed and press the "Arm/Disarm" button to activate the Bed Exit function. The footboard "Bed Exit" LED and dashboard "Bed Exit" LED will turn on.
3. To deactivate Bed Exit, press the "Arm/Disarm" button. The footboard "Bed Exit" LED and the dashboard "Bed Exit" LED will turn off.

WARNING

The Bed Exit System is intended only to aid in the detection of a patient exiting the bed. It is NOT intended to replace patient monitoring protocol. It signals when a patient is about to exit. Adding or subtracting objects from the bed after arming the bed exit system may cause a reduction in the sensitivity of the bed exit system. To avoid possible injury and to assure proper operation when using a powered mattress replacement system such as XPRT, do not initialize ("Arm") bed exit with Percussion, Vibration, Rotation or Turn Assist active. The patient motion and position resulting from a dynamic therapy mattress may adversely affect bed exit system performance.

Operation

CHAPERONE BED EXIT WITH ZONE CONTROL (OPTIONAL)

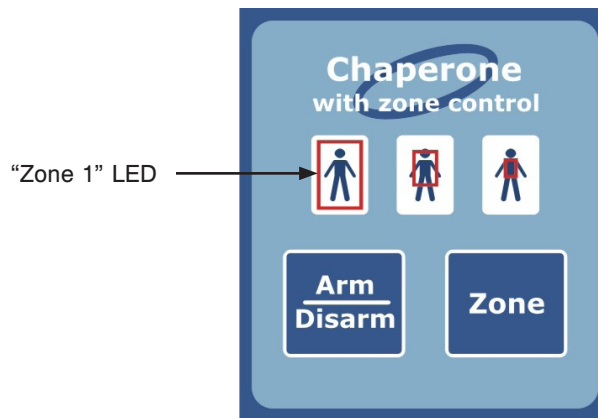

1. Before positioning the patient on the bed, the scale system must be zeroed for the Bed Exit System to function properly (see page 37 for instructions on zeroing the scale system).
2. Position the patient on the bed and press the “Arm/Disarm” button to activate the Bed Exit function. The footboard “Zone 1” LED and dashboard “Bed Exit” LED will turn on.
3. The Bed Exit system with Zone Control automatically selects Zone 1. To change the Zone, press and hold the “Zone” button until the light indicating the desired Zone comes on.
4. To deactivate Bed Exit, press the “Arm/Disarm” button. The selected footboard Zone light and the dashboard “Bed Exit” lights will turn off.

WARNING

To avoid possible injury and to assure proper operation when using a powered mattress replacement system such as XPRT, do not initialize (“arm”) bed exit with Percussion, Vibration, Rotation or Turn Assist active. The patient motion and position resulting from a dynamic therapy mattress may adversely affect bed exit system performance.

Chaperone Zone Settings

The first zone (left indicator light) is the traditional Bed Exit zone. The patient can move around the bed freely but cannot fully exit the bed or the alarm will sound.

The second zone (middle indicator light) is more restrictive than the first zone. When the zone is selected, the bed measures the location of the patient’s center of gravity. If the patient’s center of gravity moves from the original location more than 6.5 inches to either side or 13 inches toward the head or foot, an alarm will sound.

The third zone (right indicator light) is the most restrictive zone. When the zone is selected, the bed measures the location of the patient’s center of gravity. If the patient’s center of gravity moves from the original location more than 1 inch to either side or 1 inch toward the head or foot, an alarm will sound.

NOTE

All zone dimensions are $\pm .5$ inches.

Operation

SCALE SYSTEM (OPTIONAL)

Weighing a Patient on the Scale System

The scale feature provides information to the caregiver on the weight of a patient.

To Weigh a Patient:



1. Press and hold the  (“Scale”) button.
2. “**Release Button**” message flashes on the display as shown in figure 40.
3. Release the “Scale” button.
4. After the “Scale button has been released, “**Weighing ... Do Not Touch Bed**” message will flash on the display as shown in Figure 41.
5. When weighing has been completed, the patient’s weight will be displayed on the status screen as shown in Figure 42. The patient weight displayed is stored in the system for later use.

NOTE

- Pressing the scale button again within 60 seconds of the first press (this means that the scale data is still being displayed on the status screen), will remove the data from the screen. This second button press will remove the data so that the operator can walk away and not worry about having the data available to non authorized persons. The second button press will not log a value into the weight log. If the operator would like to have two consecutive readings within 60 seconds, then the operator will need to press the button once for the first weight reading, a second time will remove the weight information from the display and then a third time to take another weight reading
- If weight is displayed the “Scale” button can be pressed to turn off the scale.



Figure 40



Figure 41



Figure 42

CAUTION

Scale function may be affected by siderail/caster interference. With the litter fully lowered or lowered in Reverse Trendelenburg, the siderails tucked under the litter in the storage position and the casters turned, there is the potential for interference between the siderail and the caster. Raise the siderails when lowering the litter to the full down position to prevent the interference from causing the scale system to weigh inaccurately.

WARNING

To avoid possible injury and to assure proper operation when using a powered mattress replacement system such as XPRT:

- Confirm proper scale system operation following mattress installation. For best results, secure the mattress power cord to prevent damage to the cord and interference with the bed frame and the scale system.
- Do not zero bed scales or weigh patient with Percussion, Vibration, Rotation or Turn Assist active. Patient motion and position resulting from the dynamic therapy mattress may adversely affect scale system performance.

Operation

SCALE SYSTEM (OPTIONAL)

Zeroing The Scale System

This feature provides the operator to zero the bed prior to weighing patient. Do not zero the bed while a patient is in the bed. If this should occur, remove the patient and zero the bed again. If the Bed Exit is armed, you must disarm it before the scale can be zeroed.

To Zero the Bed:



1. Press and hold the "Zero" button.
2. "Hold to Zero Bed" message will appear briefly on the display as shown in figure 43.
3. Immediately following the "Hold to Zero Bed" message, the "Release Button" message will flash on the display as shown in Figure 44.
4. Release the "Zero" button.
5. After the "Zero" button has been released, "Do Not Touch Bed" message will flash on the display as shown in Figure 45.
6. When zeroing has been completed:
 - a. "Zeroing Successful" message will be shown on the display as shown in Figure 46.
 - b. The Dashboard Bed Zero LED will illuminate.
 - c. The display will show the status screen with the scale information as shown in Figure 47.
7. The bed is now ready for the patient.



Figure 43



Figure 44



Figure 45



Figure 46



Figure 47

Note

If there is a problem with a load cell or another component of the scale system, the system will try to zero up to 30 seconds, after which the scale monitor will read: "Unable to Zero - Try Again" if unsuccessful.

If the problem continues after three attempts, the scale system will lock and the scale monitor will read: "Unable to Zero".

Operation

MENU

- The Main Menu screen contains selectable product features to the caregiver. There are eight features listed in the main menu as ordered below:

1. Weight Log (Weight Log is the Default Selection)	5. Scale Units (Change Scale Units)
2. Gain/Loss	6. Backlight (Backlighting)
3. Change Equip. (Change Equipment)	7. Advanced Options
4. Change Ptnt. Wgt. (Change Patient Weight)	8. Exit Menu

- To select a feature, press the “Menu Up” and “Menu Down” button to scroll to the desired feature. Highlight the desired feature to select and then press the “Enter” button.

1. Weight Log

This feature provides the operator up to 10 of the last weights logged by the scale system as shown in Figure 3.

To display a list of the previous 10 weight readings:

- Press the “Menu” button and select the item “Weight Log”.
- Press the “Up” or “Down” buttons to scroll through the weight log.
- A weight reading is logged each time the scale button is pressed and the bed is in the scale mode for at least 15 seconds.
- The first weight reading displayed (1.) is the most recent. If the change in the patient’s weight since the last reading was taken is less than .2 pounds, the log will not update. Zeroing the scale system clears the weight log.



Figure 3

2. Gain/Loss

This feature provides information to the caregiver on the weight gain or loss of the patient.

To enable:

- Select “Gain/Loss” in the menu then press the “Enter” button, Figure 4 will be displayed.
- When “**Release Button**” message flashes on the display, release the “Enter” button; “**Do Not Touch Bed**” message will flash on the display.
- When Gain/Loss is On, “**Gain/Loss Enabled**” message displays.



Figure 4

NOTE: Refer to Figure 5

- The base represents the scale weight when the gain/loss feature was enabled.
- The second piece of information represents the “Gain” or the “Loss” and the weight difference between the current displayed weight and the saved base weight.



Figure 5

NOTE: Refer to Figure 6

- If the Gain or the Loss exceeds 99.9 lb, then the system will display ‘---’ instead of a value.



Figure 6

MENU (CONTINUED)

3. Change Equipment

The change equipment feature allows the operator to add or remove item from the product without affecting the patient weight.

To Change Equipment:

- Select “Change Equip.” in the menu then press the “Enter” button, Figure 7 will be displayed or if the operator did not press the button long enough the message “Hold Button Longer” will appear in the message window.
- When “**Release to Start**” message displays on the screen, release the “Enter” button; “**Do Not Touch Bed**” message will flash on display.
- Figure 8 will display when the system is ready to change equipment.
- Press the “Enter” button to Add/Remove equipment or press the “Exit” button to cancel operation.
 - If “Enter” is pressed to Add/Remove Equipment then the message “**Do Not Touch Bed**” will flash on the display.
 - If “Exit” is pressed, “**Operation Canceled**” message will display.
- Figure 9 will be displayed when the system completes the change equipment adjustment.
- The status screen will then display the weight of the patient only.



Figure 7



Figure 8



Figure 9

4. Change Patient Weight

The change patient feature allows the operator to add or remove weight from the patient weight.

To Change Patient Weight:

- Select “Change Pnt. Wgt.” in the menu.
- Press and hold the “Enter” button, Figure 10 will be displayed.
- When “**Release Button**” message displays on the screen, release the “Enter” button; “**Do Not Touch Bed**” message will flash on display.
- When the system is ready to change patient weight the following information will be displayed:
 - Allow used to Change patient Weight using arrow button;
 - Display the new patient weight;
 - Press “Enter” when done;
 - Press “Exit” to cancel operation.
- If “Enter” is pressed, the message “**Do Not Touch Bed**” will flash on the display.
- If “Exit” is pressed, “**Patient Weight Changed**” message will display.



Figure 10

Operation

MENU (CONTINUED)

5. Scale Units

- The Change Scale Units feature allows the operator to select the unit of value (lb or kg) for the scale information that is presented on the display.
- When the change scale units is selected, Figure 11 is displayed.
- This screen will highlight the current scale unit setting.
- To change the scale unit setting, scroll to the desired setting and press the “Enter” button.
- The default setting is “lb”



Figure 11

6. Backlight

- When the backlight feature is selected the display will change to the backlight selection screen as shown in Figure 12.
- This screen will highlight the current backlight setting.
- Five settings are available for the backlight; Off, Low, Medium, High and Nurse Call Only.
- To change the backlight setting; scroll to the desired setting and press the “Enter” Button; “**Save Successful**” message will display.
- The default setting is “Low”.

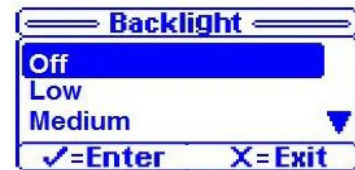

Figure 12

7. Advanced Options

The advanced menu items include:

1. Choose Exit Alarm
2. Brake Alarm
3. Awareness Alarm
4. Status To N/C

Advanced Options: Choose Exit Alarm

The caregiver can choose between 10 exit alarms.

To Select Alarm:

- Select “Choose Exit Alarm” from the menu.
- Scroll through the 10 Tone Patterns listed in the menu. A sample alarm will sound for each Tone Pattern highlighted.
- Select desired Tone Pattern and Press “Enter”
- “**Save Successful**” message will be displayed.

MENU (CONTINUED)

Advanced Options: Brake Alarm

The caregiver can enable or disable an audible brake alarm feature. If enabled and the brakes are not engaged when the bed is plugged in, an audible alarm will occur. This feature is only available on non-Zoom® beds.

To Enable/Disable Brake Alarm:

- Select “Brake Alarm” from the menu.
- Use the Up and Down Arrow buttons to select enable or disable the alarm.
- Press “Enter” to save the alarm state.
- **“Save Successful”** message will be displayed.

Advanced Options: iBed® Awareness Alarm (Audible)

The caregiver can enable or disable an audible alarm for iBed® Awareness alert states.

To Enable/Disable Alarm:

- Select “Awareness Alarm” from the menu.
- Select “On” to Enable or “Off” to disable and then press “Enter”
- **“Save Successful”** message will be displayed.

Advanced Options: Status Nurse Call (iBed® Awareness Priority Signal)

The caregiver can enable or disable a priority signal alarm through the Nurse call system based on an iBed® Awareness alarm state.

To Enable/Disable Alarm:

- Select “Status To N/C” from the menu.
- Select “On” to Enable or “Off” to disable and then press “Enter”
- **“Save Successful”** message will be displayed.

8. Exit Menu

Exits Main Menu screen and returns display to the default Status Screen.

Operation

/BED AWARENESS INTENDED USE

The *iBed*[®] Awareness system is intended to serve as a secondary monitoring system, informing the operator via a visual or audible alert when a preset condition changes.

- When the *iBed*[®] Awareness is turned “On”, the system has the ability to automatically monitor the following:
 - Brake Set/Not Set
 - Siderail Position
- Additionally, when the bed is in low height and/or Chaperone Bed Exit with Zone Control system is armed and/or the Fowler 30+ is “On”, the system has the ability to monitor these features independently when *iBed*[®] Awareness is turned “On”.

/BED[®] AWARENESS FUNCTIONALITY

- The *iBed*[®] Awareness provides functionality that will monitor status conditions on the product and produce an alert if the state had changed.
- When the system is turned “On”, it monitors each of the siderail positions and brake automatically. If the bed is in Low Height and/or the Bed Exit is armed and/or the Fowler 30⁰⁺ lock is “On”, the system will also monitor these features when *iBed*[®] Awareness is turned “On”. Note: If the Fowler 30⁰⁺ lock is “On” before *iBed*[®] Awareness is “On”, the system will also monitor the Fowler 30⁰⁺ lock.
- In the event of a power loss, the *iBed*[®] Awareness system will store the last known condition and when power is restored it will operate in this condition.
- *iBed*[®] Awareness will not be able to be turned “On” if any system error conditions exist that impede the function of the *iBed*[®] Awareness system. The system errors that affect this feature include the four siderail sensors, the scale system, the Fowler 30⁰⁺ lock and the bed exit system. For details on error codes, refer to the Maintenance Manual.

/BED[®] AWARENESS LIGHT BAR AND SIDE LIGHTS

A light bar, located centrally on the front of the footboard, will illuminate and indicate the state of the *iBed*[®] Awareness system. Side lights located on the sides of the footboard will behave identical to the center light.

Features

- When the *iBed*[®] Awareness system is “On” the light bar turns green.
- If an alert state on the *iBed*[®] Awareness system is triggered, the light bar will change to the alert state and flash AMBER.
- During an alert state, an AMBER dashboard LED associated with the alert will blink on the footboard and the display screen will show the details of the alert state.

/BED[®] AWARENESS ON/OFF BUTTON

The On/Off control button is used to turn the *iBed*[®] Awareness system “On” and “Off”.

Features

When the button is pressed the *iBed*[®] Awareness system will save information based on the current state of the product and based on the system rules will commence monitoring.

Turning on the *iBed*[®] Awareness system

1. Press the *iBed* On/Off button.
2. The following message will be displayed on the screen: **“Awareness On”**.

Turning off the *iBed*[®] Awareness system

1. Press and hold the *iBed* On/Off button.
2. The following message will be displayed on the screen: **“Awareness Off”**.

Operation

iBED® AWARENESS MONITORING AND ALARMS

Low Height

- If the low height state changes:
 1. The low height LED on the dashboard blinks and the display screen flashes between the message in Figure 13 and the message in Figure 14.

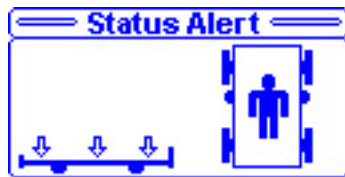

Figure 13



Figure 14

Brakes

- If the brake state changes:
 1. The brake LED on the dashboard blinks and the display screen flashes between the message in Figure 15 and the message in Figure 16.

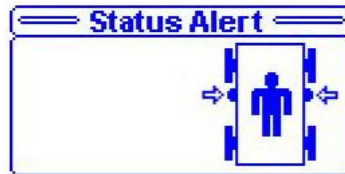

Figure 15



Figure 16

Siderails

- If the siderail state changes:
 1. The siderail LED on the dashboard blinks and the display screen flashes between the message in Figure 17 and the message in Figure 18.



Figure 17



Figure 18

Note

The arrow pointing to the siderail in Figure 17 and 18 will change depending on the siderail position in alarm.

Operation

iBED® AWARENESS MONITORING AND ALARMS (CONTINUED)

Bed Exit

- If the bed exit is disarmed:
 1. The bed exit LED on the dashboard blinks and the display screen flashes between the message in Figure 19 and the message in Figure 20.



Figure 19



Figure 20

Fowler 30⁰+ Lock

- If the fowler 30⁰+ lock state changes from a locked to an unlocked state:
 1. The fowler 30⁰+ lock LED on the dashboard blinks and the display screen flashes between the message in Figure 21 and the message in Figure 22.



Figure 21

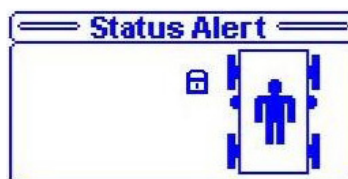

Figure 22

- If the fowler 30⁰+ lock state changes to a lowered position:
 1. The fowler 30⁰+ lock LED on the dashboard blinks and the display screen flashes between the message in Figure 23 message and the message in Figure 24.



Figure 23



Figure 24

Additional Alarm Conditions

- If an audible alarm is required, the caregiver can set the Awareness alarm to "On" through the Advanced Options Menu in the Main Menu.
- If the caregiver would like to set the Awareness alarm to the Nurse Call Station, the "Status To N/C" must be turned "On" through the Advanced Options Menu in the Main Menu.

Note

- By default these two advanced options are turned "Off".

Operation

iBED® AWARENESS LOCKS

Fowler 30⁰⁺ Lock button

- The Fowler 30⁰⁺ lock is a dual purpose button. It positions the Fowler to 30⁰ and removes the bed out of trend.
- When the Fowler 30⁰⁺ lock button is pressed, the bed will reposition if it needs to and Figure 25 will be displayed.
- Once the bed reaches its final position, Figure 26 will be displayed.
- If the button is not held until the final position is reached Figure 27 will be displayed.
- If bed is put in CPR position manually or by pressing the CPR button, Figure 28 will be displayed.
- If the bed is at its final fowler 30⁰⁺ position (Trend = 0⁰, fowler = 30⁰) and the user presses either the fowler down or trend buttons, the display will toggle between figures 31 and 32.



Figure 25



Figure 26



Figure 27



Figure 28

Bed Motion Lock

- If Bed Motion lock button is pressed, Figure 29 will be displayed.
- If Bed Motion lock button is pressed when already "on" then Figure 30 will be displayed.
- If Motion is attempted when lock is "On," the display screen flashes between Figure 31 and 32.



Figure 29



Figure 30



Figure 31



Figure 32

Note: The CPR Drop button overrides all locks.

Patient Control Locks

- If any of the Patient Control lock buttons are pressed, Figure 29 as shown above will be displayed.
- If any of the Patient Control lock buttons are pressed when already "on" then Figure 30 as shown above will be displayed.

Operation

BATTERY BACKUP PANEL (OPTIONAL)

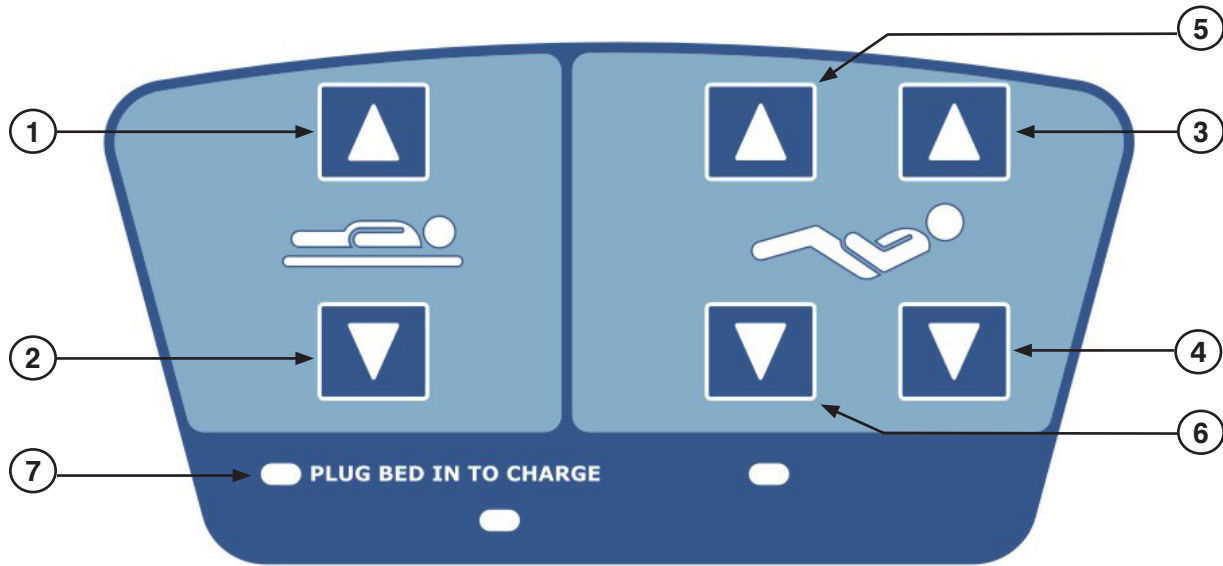

Button	Button Name	Button Function
1	Bed/Litter Up	Press and hold to raise the Bed/Litter.
2	Bed/Litter Down	Press and hold to lower the Bed/Litter.
3	Fowler Up	Press to raise the Fowler.
4	Fowler Down	Press to lower the Fowler.
5	Knee Gatch Up	Press to raise the Knee Gatch.
6	Knee Gatch Down	Press to lower the Knee Gatch.
7	Plug Bed In To Charge LED	The "Plug Bed In To Charge" LED will be illuminated while the battery power switch is on if the battery level is low. Plug the bed power cord into the wall socket to charge the batteries.

Operation

ZOOM MOTORIZED DRIVE PANEL (OPTIONAL)

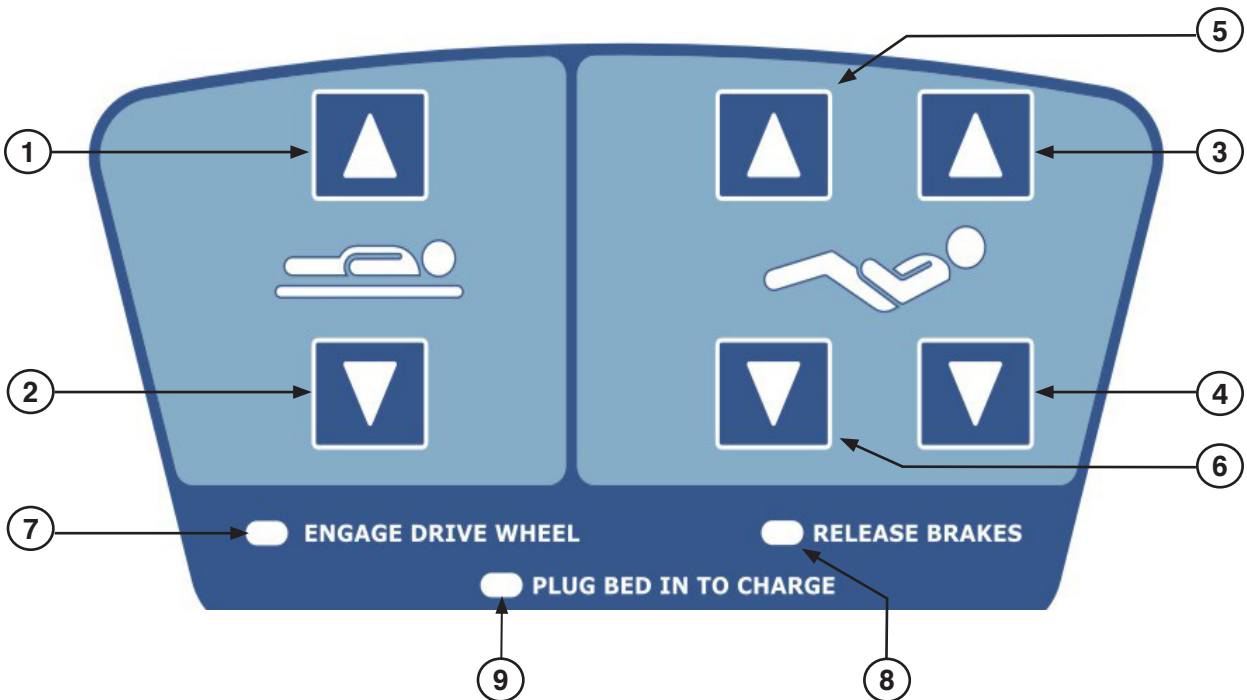

Button	Button Name	Button Function
1	Bed/Litter Up	Press and hold to raise the Bed/Litter.
2	Bed/Litter Down	Press and hold to lower the Bed/Litter.
3	Fowler Up	Press to raise the Fowler.
4	Fowler Down	Press to lower the Fowler.
5	Knee Gatch Up	Press to raise the Knee Gatch.
6	Knee Gatch Down	Press to lower the Knee Gatch.
7	Engage Drive Wheel LED	The "Engage Drive Wheel" LED will be illuminated whenever the battery power switch is on and the drive wheel pedal is in the neutral position. The light will go off when the drive wheel is in the drive position.
8	Release Brakes LED	The "Release Brakes" LED will be illuminated whenever the bed's brakes are engaged while the battery power switch is on. The light will go off when the brakes are disengaged.
9	Plug Bed In To Charge LED	The "Plug Bed In To Charge" LED will be illuminated while the battery power switch is on if the battery level is low. Plug the bed power cord into the wall socket to charge the batteries.

Operation

ZOOM MOTORIZED DRIVE OPERATION

1. Unplug the power cord from the wall socket and secure the cord sufficiently to prevent entanglement while the unit is in motion. The drive wheel will not operate if the power cord is plugged into the wall socket.
2. Activate the power to the drive wheel by placing the battery power switch located at the left side of the head end of the litter in the "ON" position. The LED will illuminate.

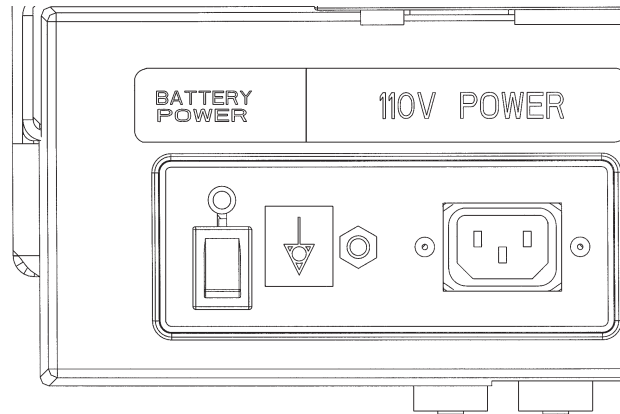

3. Engage the drive wheel by rotating the pedal to the left (located at the head end on top of switch as shown on the label). To place the drive wheel in the neutral position, rotate the pedal to the right.

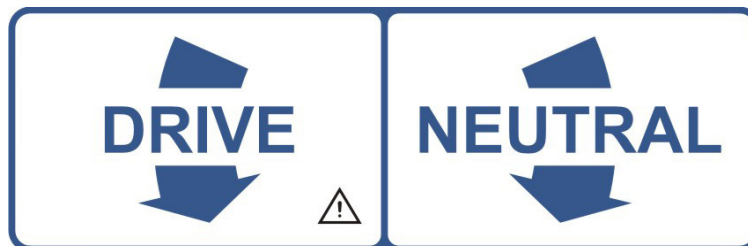

4. Release the brakes. The drive system will not function while the brakes are engaged. The "Release Brakes" LED on the head end control panel will be illuminated if the brakes are engaged while the battery power switch is on.

WARNING

- Use caution while maneuvering the unit with the drive wheel activated. Injury to the patient, user, or others, or damage to the bed or surrounding equipment could occur if the bed collides with an obstacle. Always ensure there are no obstacles near the unit while the drive wheel is activated.
- Use caution when transporting the unit down halls, through doors, in and out of elevators, etc. Damage to the siderails or other parts of the unit could occur if the unit comes in contact with walls or door frames.

Operation

ZOOM MOTORIZED DRIVE OPERATION (CONTINUED)

5. Grasp the drive handle at the two raised grip areas. Squeeze either of the motion release switches (A) located under the handle and push handle bar to enable the movement of the drive wheel. Either or both switches will enable movement, but both switches must be released to stop movement.

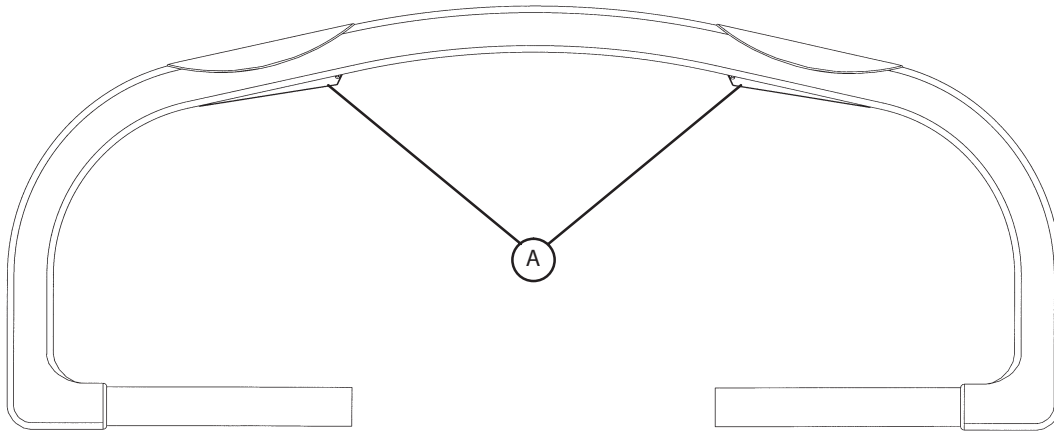

6. While continuing to squeeze the switch(es), push the handle away from you or pull the handle toward you to initiate motion in that direction. The forward speed will increase proportionally to the distance the drive handle is moved. i.e. the further forward the drive handle is pushed, the faster the unit will move.
To stop motion, remove your hands from the switches and the handle.

Note

The drive wheel does not pivot. The unit cannot be moved directly sideways with the drive wheel engaged. With the drive wheel pedal in the neutral position and the unit's brakes released, the unit can be moved in any direction including sideways.

Driving a Zoom® equipped unit over liquids or slick surfaces could decrease the traction of the drive wheel.

WARNING

Put the drive wheel in the neutral position and release the brakes before pushing the unit manually. **Do not** attempt to push the unit manually with the drive wheel engaged. The unit will be difficult to push and injury could result.

CAUTION

When attaching equipment to the frame, ensure it will not impede normal operation. For example: hooks on hanging equipment must not actuate control buttons, equipment must not hide the nurse call button, foley bags must not rest on brake pedal, etc.

Operation

BATTERY CHARGING AND OPERATION

Note

This applies to beds that are equipped with an option for Zoom® or battery backup.

Operation

- The unit has two 12 volt batteries to provide power to the drive wheel and backup power to the unit functions if the power cord is unplugged from the wall socket. Neither the unit functions nor the drive wheel will operate properly if the batteries are not sufficiently charged. The batteries require approximately 10 hours of charging time when they are fully discharged.
- The batteries are charging whenever the power cord is plugged into a properly grounded, hospital grade wall socket. When the unit is stationary, the power cord should be plugged into a wall socket whenever possible.

Charging

1. The “Plug Bed In To Charge” LED on the Head End Control Panel will be illuminated while the battery power switch is on if the battery level is low (see [page 45](#) for beds with battery backup option and [page 46](#) for bed with Zoom®). Plug the power cord into a wall socket to charge the batteries.
2. After one hour on battery power with no motion release switch activation, the unit will enter power save mode and none of the unit’s powered functions will operate. Squeeze either of the motion release switches located under the drive handle to enable the unit functions.

Note (Zoom® Option Only)

The three LED’s on the Head End Control Panel may still be illuminated when the unit is in power save mode. The Battery Power Switch LED located at the left side of the head end of the unit will be illuminated when the unit is in power save mode.



WARNING

The power save mode is activated after one hour on battery power with no motion release switch activation. Functions including Bed Exit, Scale and Motion will cease to operate when the unit enters the power save mode. Injury to the patient could occur if proper patient monitoring protocol is not observed.

Operation

PENDANT - MOTION/NURSE CALL (3006-315-011)

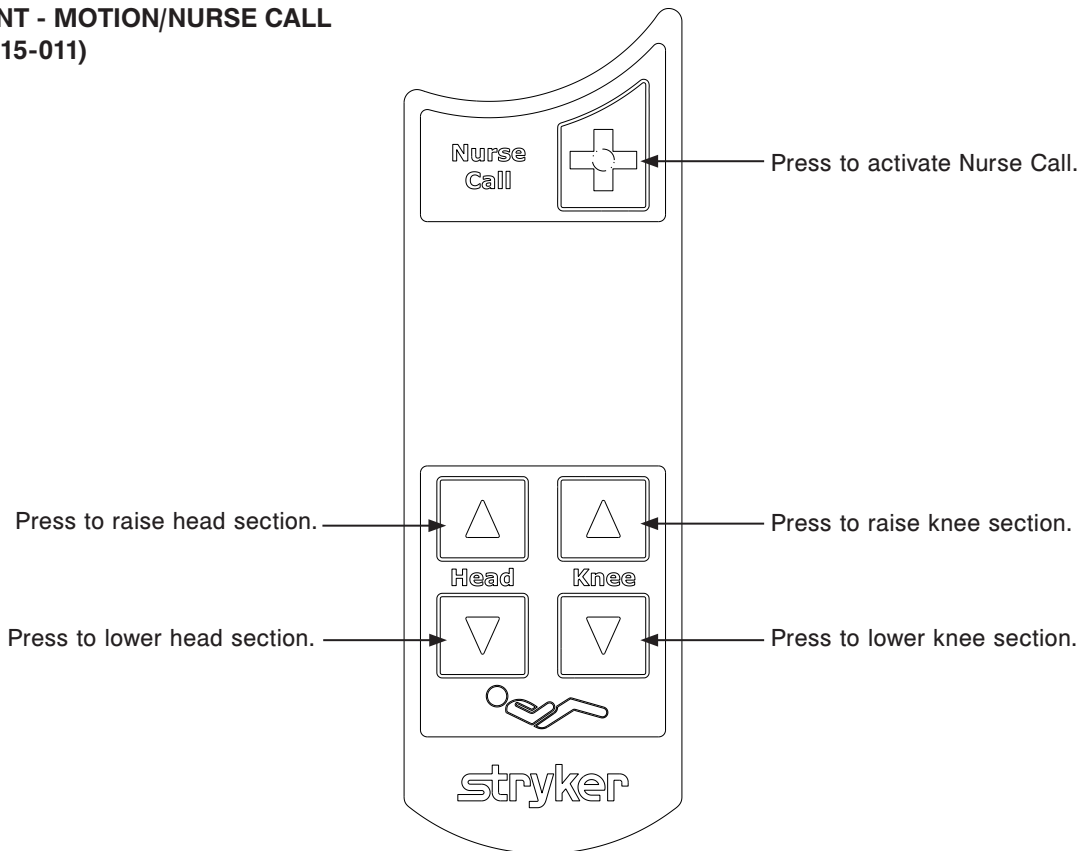

PENDANT - MOTION/NURSE CALL/SMART TV (DIGITAL) (3006-315-012)

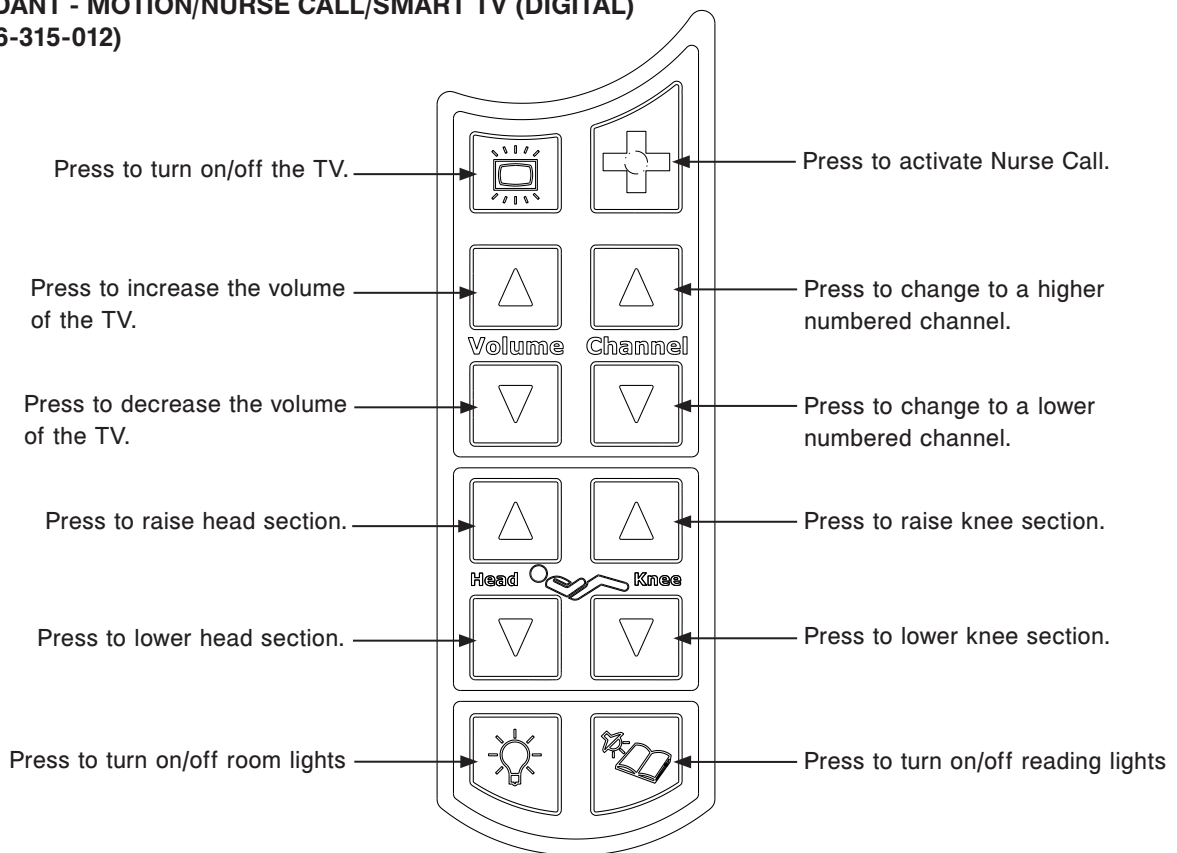

Operation

OPTIONAL INFRARED (IR) MODULE

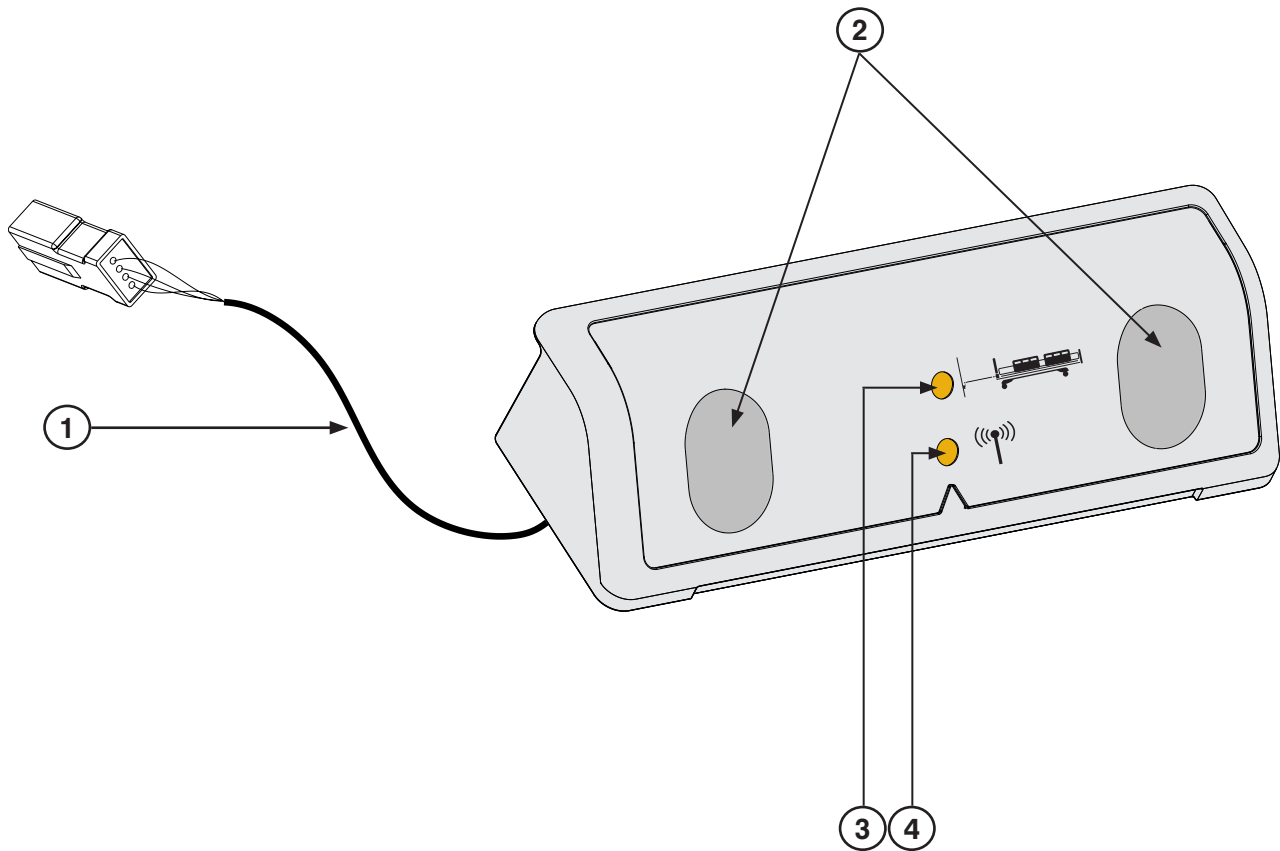

Item	Name	Function
1	IR (Infrared) Module Cable	Connects to the bed and provides power and signal communications.
2	IR (Infrared) Lens	Provides infrared communications with the <i>i</i> Bed Locator.
3	<i>i</i> Bed Locator Connection LED	Provides connection status for IR (infrared) communications with <i>i</i> Bed Locator. Slow Flash - attempting to connect to <i>i</i> Bed Locator. Solid LED - <i>i</i> Bed Locator connected. Rapid Flash - Error condition detected. OFF - <i>i</i> Bed Locator is not trying to connect. This occurs only on Zoom® and Battery Backup beds when the brake is released.
4	Wireless (WiFi) Connection LED	Provides connection status for WiFi (wireless) communications with wireless access point. Slow Flash - WiFi attempting to connect. Solid LED = WiFi connected. Rapid Flash - WiFi was not connected after 6 minutes and timed out.

Operation

OPTIONAL /BED LOCATOR

The Optional *i*Bed Locator component provides *i*Bed Locator ID and battery status information to the IR Module. Installation and operational procedures for the Optional *i*Bed Locator are located in the *i*Bed Locator Instructions For Use manual (5212-009-101).

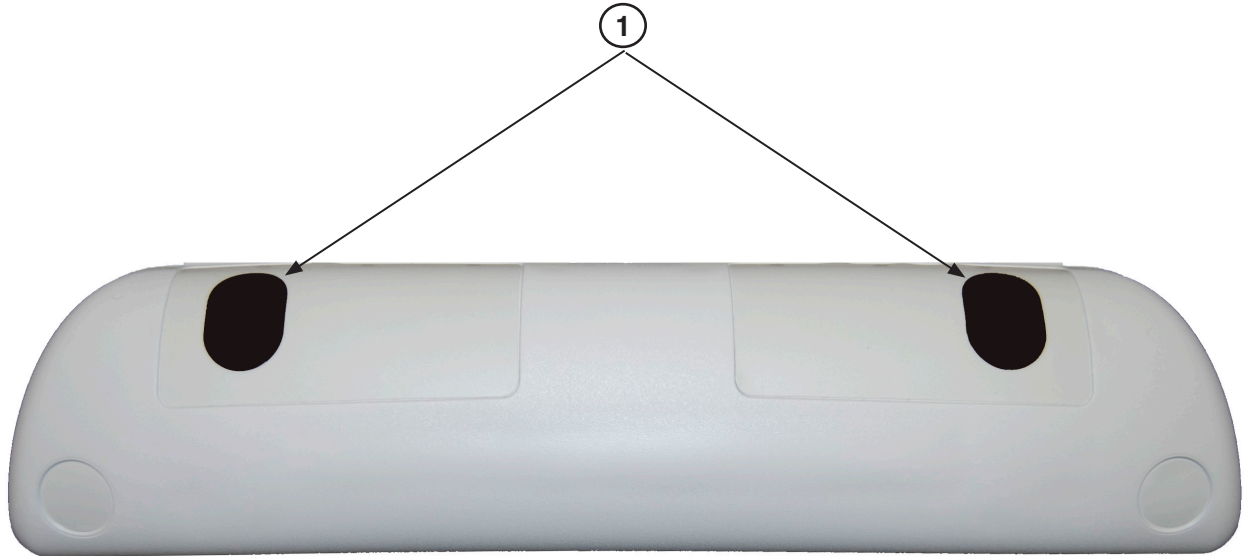

Item	Name	Function
1	IR (Infrared) Lens	Provides Infrared communications with the <i>i</i> Bed IR Module.

Preventive Maintenance

At a minimum, check all items listed during annual preventive maintenance for all Stryker products. You may need to perform preventive maintenance checks more frequently based on your level of product usage.

CHECKLIST

- _____ All fasteners secure (reference all assembly drawings)
- _____ Engage brake pedal and push on the bed to ensure all casters lock securely.
- _____ Inspect the brake assembly (Brake Ratchet Spring and Brake Bar) for degradation or signs of wear at the foot end and head end of the bed. Ensure brake assembly components (locking caster and springs) are functioning properly.
- _____ "Brake" LED on the footboard and head end siderails blink when brakes are not engaged.
- _____ Locking steer caster engages and disengages properly.
- _____ Siderails move, latch and stow properly.
- _____ CPR release working properly.
- _____ Foot prop intact and working properly.
- _____ I.V. pole working properly.
- _____ Foley bag hooks intact.
- _____ No cracks or splits in head and footboards.
- _____ No rips or cracks in mattress cover.
- _____ All functions on head end siderails working properly (including LED's).
- _____ All functions on footboard working properly (including LED's).
- _____ Scale and Bed Exit system calibrated properly.
- _____ Motion Interrupt switches working properly.
- _____ Night light working properly.
- _____ Power cord and plug not frayed or damaged.
- _____ No cables worn or pinched.
- _____ All electrical connections tight.
- _____ All grounds secure to the frame.
- _____ Ground impedance not more than 100 mΩ (milliohms).
- _____ Current leakage not more than 300 μA (microamps).
- _____ Apply grease to the Litter grease points and fowler motor clutch ([see page 55 for locations](#)).
- _____ Engage drive wheel and ensure it is operating properly (Zoom® option).
- _____ Motion release switches working properly (Zoom® option).
- _____ Confirm Head End Control Panel functionality (Zoom® / Battery Backup option).
- _____ Confirm battery powered functionality (Zoom® / Battery Backup option).
- _____ Ensure ground chains are clean, intact, and have at least two links touching the floor.
- _____ Check Fowler angle for accuracy 0° - 60°.
- _____ Siderail switches working properly (iBed® Awareness option).
- _____ Center Light Bar LED and side light LED working properly (iBed® Awareness option).
- _____ Inspect footboard control labeling for signs of degradation.
- _____ Inspect siderail gas spring for oil leaks and replace if necessary.
- _____ Check fowler motor flexible mounting for damage or wear.
- _____ Check all motion functionality.
- _____ Ensure power cord slack at the inlet filter (Zoom® and Battery Backup Option).
- _____ Check Nurse Call functionality.
- _____ Check Nurse Call battery - optional equipment
- _____ Check labels as specified in the Operations and Maintenance manuals for legibility, proper adherence and integrity.
- _____ Confirm iBed® Wireless Module and IR Module are intact and footboard icons are displaying (iBed® Wireless Option)

Bed Serial Number:		

Completed by: _____ Date: _____

Preventive Maintenance

GREASE POINTS

1. H/E Glide Rod
2. Ball Screw
3. Brake Spring

Siderail Assembly (Reference p/n: 3006-400-105 (Head End) and 3006-400-300 (Foot End))

1. Apply Syn-Tech NS-18191-G grease (p/n 3000-200-700) to Glide Rod surface.

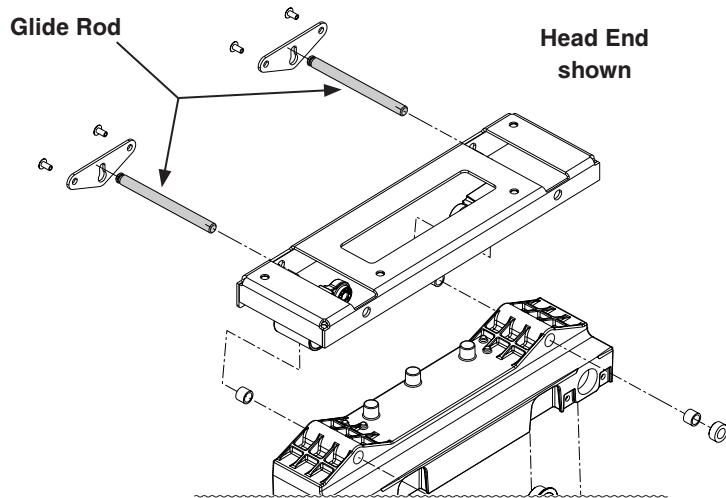

Fowler Drive Assembly (Reference p/n: 3006-300-550)

1. Apply Mobile #28 grease to entire length of ball screw.
2. If dry, apply a thin film layer of Syn-Tech grease (p/n 3000-200-700) to the outside of the brake spring.

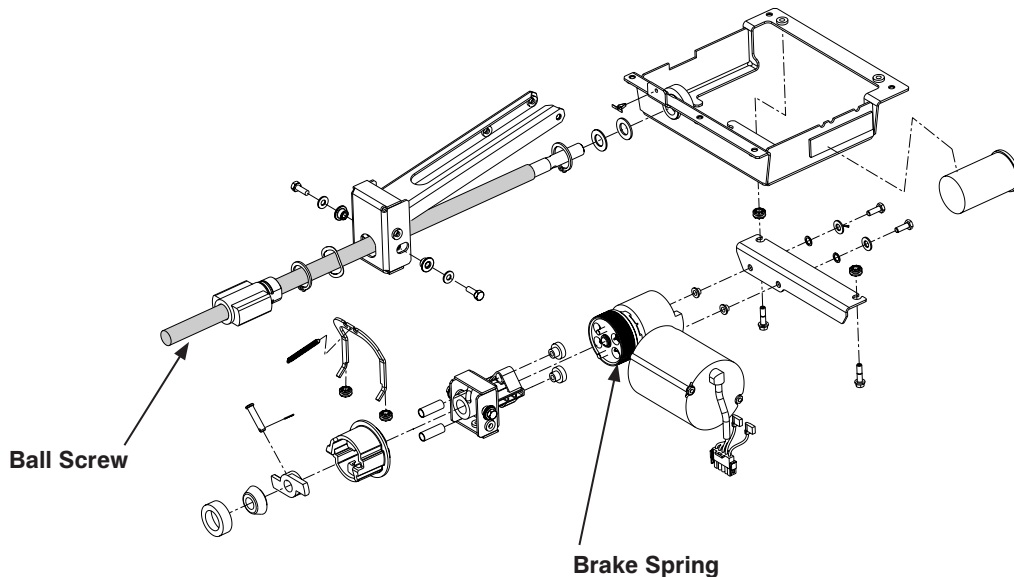

Cleaning

CAUTION

Always unplug the power cord during service or cleaning.

Hand wash all surfaces of the bed with warm water and mild detergent. DRY THOROUGHLY. Do not steam clean or hose off the S3® MedSurg Bed, Model 3002. Do not immerse any part of the bed. Some of the internal parts of the bed are electric and may be damaged by exposure to water.

Suggested cleaners for bed surfaces:

- Quaternary Cleaners (active ingredient – ammonium chloride)
- Phenolic Cleaners (active ingredient – o-phenylphenol)
- Chlorinated Bleach Solution (5.25% – less than 1 part bleach to 100 parts water)

Avoid over saturation and ensure the product does not stay wet longer than the chemical manufacturer's guidelines for proper disinfecting.

CAUTION





Some cleaning products are corrosive in nature and may cause damage to the product if used improperly. If the products described above are used to clean Stryker patient care equipment, measures must be taken to insure the beds are wiped with a damp cloth soaked in clean water and thoroughly dried following cleaning. Failure to properly rinse and dry the beds will leave a corrosive residue on the surface of the bed, possibly causing premature corrosion of critical components. Failure to follow the above directions when using these types of cleaners may void this product's warranty.

For mattress cleaning instructions, please see the tag on the mattress, or contact the mattress manufacturer.

Clean Velcro AFTER EACH USE. Saturate Velcro with disinfectant and allow disinfectant to evaporate. (Appropriate disinfectant for nylon Velcro should be determined by the hospital).

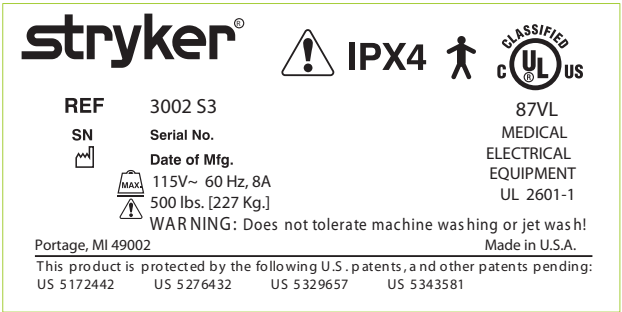
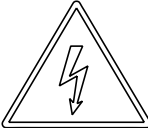

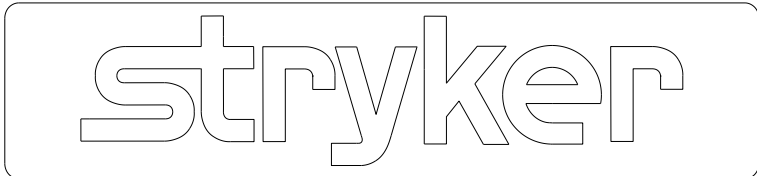

Product Labels

Note: All product labels are standard on the bed unless otherwise noted as being optional.

Part Name/Number	Product Label
<p>Specification Label 3006-300-625</p>	
<p>Shock Hazard 3006-002-708</p>	 <p>CAUTION: No user serviceable part inside. To reduce the risk of electric shock, do not remove cover.</p> <p>Refer servicing to qualified service personnel.</p>
<p>Steer Lock 3006-090-013</p>	
<p>Base Logo 3006-200-602</p>	
<p>Caution/Danger Label 5212-100-807</p>	<p>CAUTION: Adequate grounding reliability can only be achieved when the equipment is connected to an equivalent receptacle marked "Hospital Grade."</p> <p>DANGER: Explosion hazard. Do not use in the presence of flammable anesthetics.</p> <p>DANGER: Risque d'Explosion ne pas employer en presence d'Anesthésiques inflammables.</p> <p>EXPLOSIONSGEFAHR! Nicht in der naehе von feuergeraehrlichen Anästhesiemitteln verwenden.</p> 

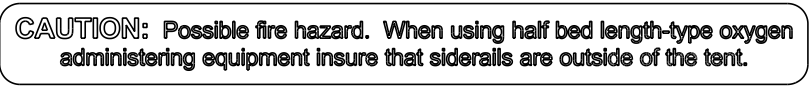

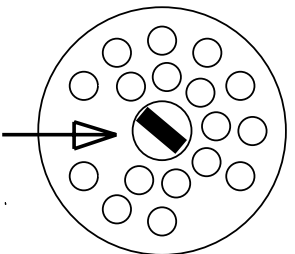
Product Labels

Note: All product labels are standard on the bed unless otherwise noted as being optional.

Part Name/Number	Product Label
<p>Caution 3006-088-820</p>	
<p>500 lb Max 3006-090-100</p>	
<p>Cord Out Label 3006-090-028</p>	<p>NOTE: TO PREVENT A LOW BATTERY CONDITION: WHEN BED IS NOT PLUGGED IN, POSITION THE CORD OUT SWITCH TO THE OFF POSITION.</p> 
<p>Brake Pedal 3006-200-601</p>	
<p>Foley Bag Hook 3006-300-601</p>	<p>ISOLATED FOLEY BAG HOOK BELOW CAUTION: Isolated hook does not retract with bed frame.</p>

Product Labels

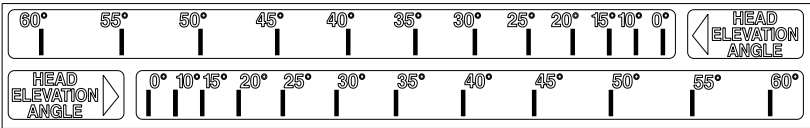
Note: All product labels are standard on the bed unless otherwise noted as being optional.

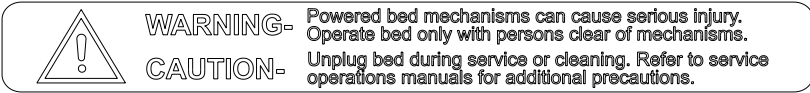
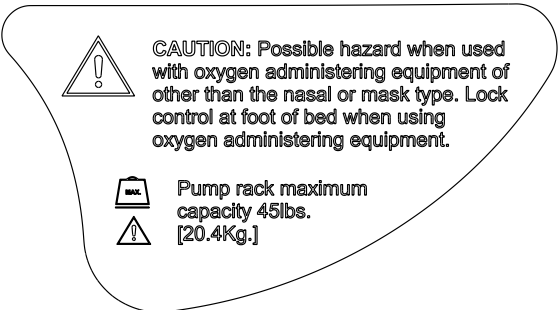
Part Name/Number	Product Label
<p>Fowler Elevation Angle 3006-300-602</p>	
<p>CPR Release 3006-300-603</p>	
<p>Release Handle 3006-400-657</p>	
<p>Warning 3006-400-656</p>	
<p>Oxygen Warning 3006-508-010</p>	

Product Labels

Note: All product labels are standard on the bed unless otherwise noted as being optional.

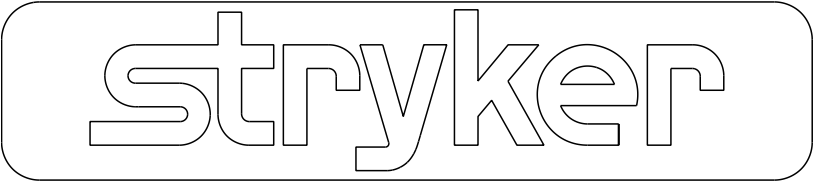
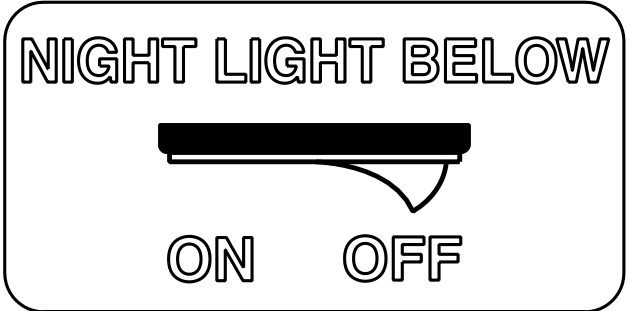
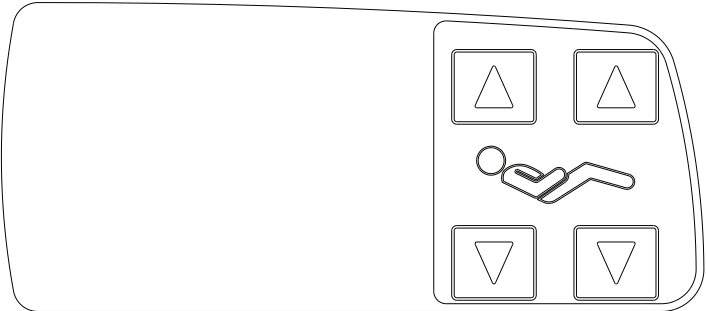
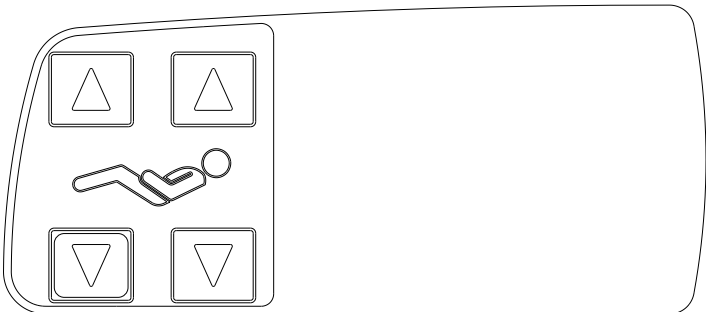
Part Name/Number	Product Label
<p>For hospital staff use only 3006-508-013</p>	 <p>A rounded rectangular label with a thin border containing the text "For hospital staff use only" in a bold, sans-serif font.</p>
<p>Stryker Logo 3006-508-014</p>	 <p>The Stryker logo, consisting of the word "stryker" in a lowercase, rounded, sans-serif font, enclosed within a rounded rectangular border.</p>
<p>Night Light 3006-310-601</p>	 <p>A label for a night light control. It features the text "NIGHT LIGHT BELOW" at the top. Below the text is a graphic of a night light fixture. At the bottom, the words "ON" and "OFF" are positioned on either side of a central vertical line.</p>
<p>Head End Inner Siderail (Left) 3006-400-620</p>	 <p>A control panel for the left inner siderail. It features a central icon of a person lying in a bed. Above the icon are two upward-pointing triangles, and below the icon are two downward-pointing triangles, all enclosed in square frames.</p>
<p>Head End Inner Siderail (Right) 3006-400-610</p>	 <p>A control panel for the right inner siderail. It features a central icon of a person lying in a bed. Above the icon are two upward-pointing triangles, and below the icon are two downward-pointing triangles, all enclosed in square frames.</p>

Product Labels

Note: All product labels are standard on the bed unless otherwise noted as being optional.

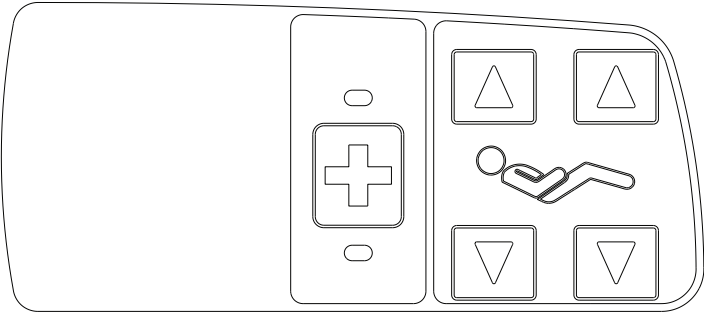
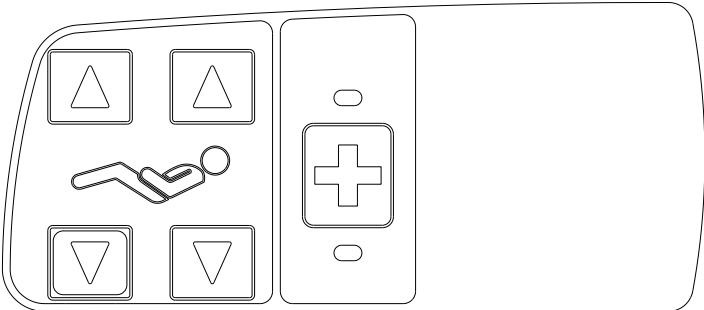
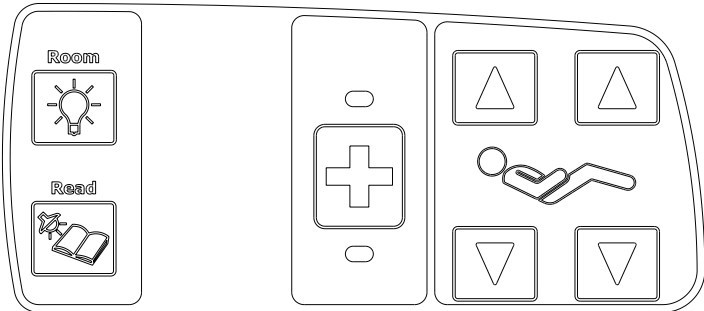
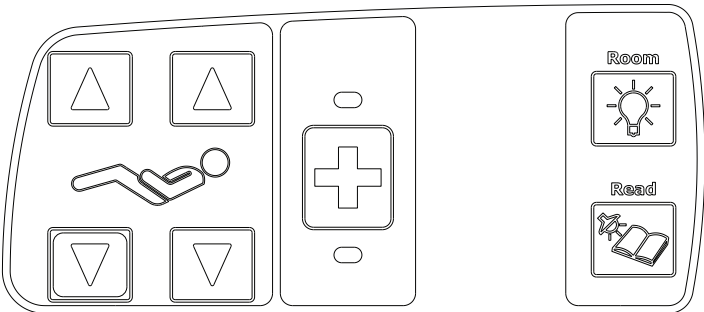
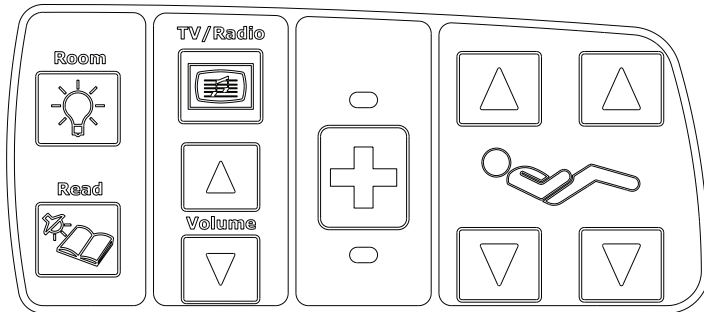
Part Name/Number	Product Label
<p>Head End Inner Siderail with NC (Left) 3006-400-621 (Optional)</p>	
<p>Head End Inner Siderail with NC (Right) 3006-400-611 (Optional)</p>	
<p>Head End Inner Siderail with Nurse Call and Lights (Left) 3006-400-625 (Optional)</p>	
<p>Head End Inner Siderail with Nurse Call and Lights (Right) 3006-400-615 (Optional)</p>	
<p>Head End Inner Siderail with Nurse Call, Lights and TV-Radio (Left) 3006-400-623 (Optional)</p>	

Product Labels

Note: All product labels are standard on the bed unless otherwise noted as being optional.

Part Name/Number	Product Label
<p>Head End Inner Siderail with Nurse Call, Lights and TV-Radio (Right) 3006-400-613 (Optional)</p>	
<p>Head End Inner Siderail with Smart TV (Left) 3006-430-131 (Optional)</p>	
<p>Head End Inner Siderail with Smart TV (Right) 3006-430-132 (Optional)</p>	
<p>Head End Outer Siderail with Cardiac Chair (Left) 3006-400-637</p>	
<p>Head End Outer Siderail with Cardiac Chair (Right) 3006-400-647</p>	

Product Labels

Note: All product labels are standard on the bed unless otherwise noted as being optional.

Part Name/Number	Product Label
<p>Head End Outer Siderail with Cardiac Chair and Nurse Call (Left) 3006-400-635 (Optional)</p>	
<p>Head End Outer Siderail with Cardiac Chair and Nurse Call (Right) 3006-400-645 (Optional)</p>	
<p>Head End Outer Siderail with Cardiac Chair and Gatch/Fowler (Left) 3006-400-634 (Optional)</p>	
<p>Head End Outer Siderail with Cardiac Chair and Gatch/Fowler (Right) 3006-400-644 (Optional)</p>	
<p>Head End Outer Siderail with Cardiac Chair, N/C and Gatch/Fowler (Left) 3006-400-633 (Optional)</p>	

Product Labels

Note: All product labels are standard on the bed unless otherwise noted as being optional.

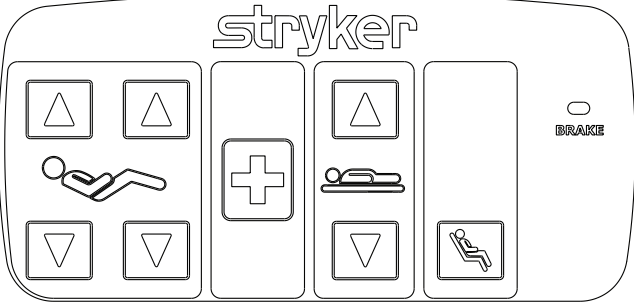
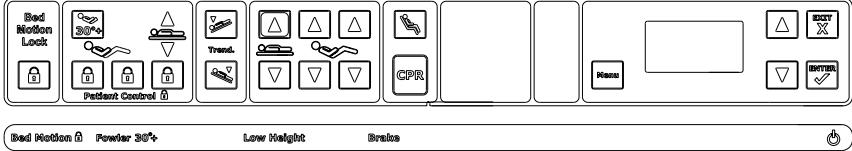
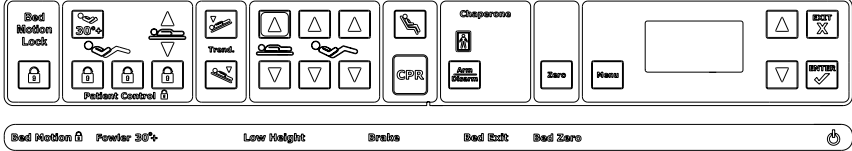
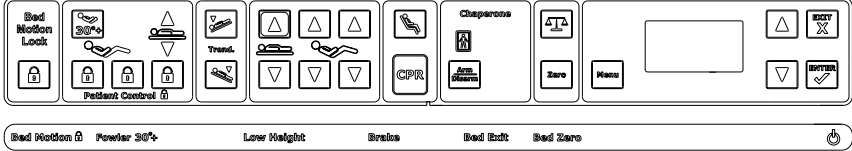
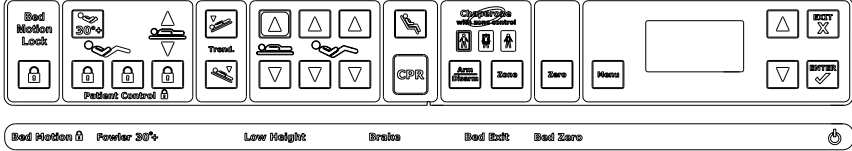
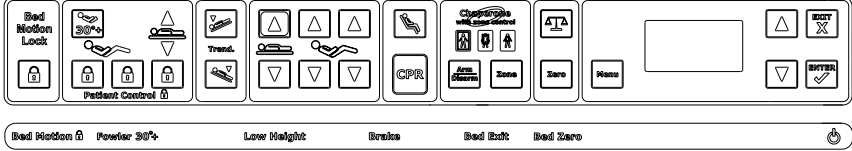
Part Name/Number	Product Label
<p>Head End Outer Siderail with Cardiac Chair, N/C and Gatch/Fowler (Right) 3006-400-643 (Optional)</p>	
<p>Footboard, without Scale and without Bed Exit 3006-508-004</p>	
<p>Footboard, with Bed Exit 3006-508-005 (Optional)</p>	
<p>Footboard, with Bed Exit and Scale 3006-508-007 (Optional)</p>	
<p>Footboard, with Bed Exit and Zone Control 3006-508-006 (Optional)</p>	
<p>Footboard, with Bed Exit, Scale and Zone Control 3006-508-009 (Optional)</p>	
<p>Bed Exit 3006-508-109 (Optional)</p>	<div style="border: 1px solid black; padding: 10px;"> <h2 style="text-align: center;">Bed Exit</h2> <p>A. BEFORE putting a NEW PATIENT on the bed:</p> <ol style="list-style-type: none"> 1. Prepare the bed for patient stay by adding linen and equipment to the bed. 2. Press and HOLD the 'ZERO' key. Follow the instructions on the display. 3. The 'BED ZERO' light will illuminate to indicate when the BED EXIT system is 'zeroed' and is ready for the patient to be helped to the bed. <p>B. To ARM BED EXIT System:</p> <ol style="list-style-type: none"> 1. Place patient on the bed. 2. Push the 'ARM / DISARM' key and release. The 'BED EXIT' light will illuminate. 3. Bed Exit system is now armed. <p>NOTE: Adding or subtracting objects from the bed after zeroing the bed will cause a change in the sensitivity of the BED EXIT system.</p> </div>

Product Labels

Note: All product labels are standard on the bed unless otherwise noted as being optional.

Part Name/Number	Product Label
<p>Bed Exit with Zone Control 3006-508-106 (Optional)</p>	<div style="border: 1px solid black; padding: 10px;"> <h3 style="text-align: center;">Bed Exit With Zone Control</h3> <p><u>A. BEFORE putting a NEW PATIENT on the bed:</u></p> <ol style="list-style-type: none"> 1. Prepare the bed for patient stay by adding linen and equipment to the bed. 2. Press and HOLD the 'ZERO' key. Follow the instructions on the display. 3. The 'BED ZERO' light will illuminate to indicate when the BED EXIT system is 'zeroed' and is ready for the patient to be helped to the bed. <p><u>B. To ARM BED EXIT System:</u></p> <ol style="list-style-type: none"> 1. Place patient on the bed. 2. Push the 'ARM / DISARM' key and release. The 'BED EXIT' light will illuminate. 3. Bed Exit with ZONE CONTROL will automatically select the first zone. To change the zone, press the 'ZONE' key until the desired zone is illuminated. 4. Bed exit system is now armed. <p><u>NOTE:</u> Adding or subtracting objects from the bed after zeroing the bed will cause a change in the sensitivity of the BED EXIT system.</p> </div>
<p>Scale System 3006-508-107 (Optional)</p>	<div style="border: 1px solid black; padding: 10px;"> <h3 style="text-align: center;">Scale System</h3> <p><u>A. BEFORE putting a NEW PATIENT on the bed:</u></p> <ol style="list-style-type: none"> 1. Prepare the bed for patient stay by adding linen and equipment to the bed. 2. Press and HOLD the 'ZERO' key. Follow the instructions on the display. 3. The 'BED ZERO' light will illuminate to indicate when the SCALE system is 'zeroed' and is ready for the patient to be helped to the bed. <p><u>B. To USE the SCALE system display:</u></p> <ol style="list-style-type: none"> 1. To display the weight; press, hold and release the 'SCALE' key. The Scale display will read: 'WEIGHING... DO NOT TOUCH BED', then 'XXX.X LB' will be displayed. <p><u>C. To change linen or equipment:</u></p> <ol style="list-style-type: none"> 1. Press the 'MENU' key, select 'CHANGE EQUIPMENT' from the menu in the display, and follow the instructions. <p><u>NOTE:</u> Adding or subtracting objects from the bed after the SCALE system has been zeroed will cause a change in weight reading. Use the CHANGE EQUIPMENT function when objects are required to be added or removed from the bed.</p> </div>
<p>Awareness Status 3006-508-108 (Optional)</p>	<div style="border: 1px solid black; padding: 10px;"> <h3 style="text-align: center;">Awareness Status</h3> <p><u>A. Awareness monitors the following:</u></p> <ol style="list-style-type: none"> 1. Brake 2. Siderail position 3. Low height (optional) 4. Bed Exit (optional) 5. Fowler 30°+ (optional) <p><u>B. BEFORE arming the Awareness system:</u></p> <ol style="list-style-type: none"> 1. Make sure the brakes are set. 2. Configure the siderails as desired. 3. If low height is to be monitored, lower the bed completely. 4. If Bed Exit is to be monitored, arm the Bed Exit system. 5. If the Fowler 30°+ is to be monitored, turn the Fowler 30°+ on. <p><u>C. To USE the Awareness system:</u></p> <ol style="list-style-type: none"> 1. Enable the Awareness system by pressing the Awareness 'ON / OFF' key. The Awareness indicator light on the footboard will turn green if the system is successfully enabled. 2. When the Awareness state has changed, the Awareness indicator light will flash amber and the 'BRAKE', 'SIDERAIL', 'LOW HEIGHT', 'BED EXIT', and / or 'FOWLER 30°+' lights will flash. The Awareness display will also indicate what has changed. </div>

Product Labels

Note: All product labels are standard on the bed unless otherwise noted as being optional.

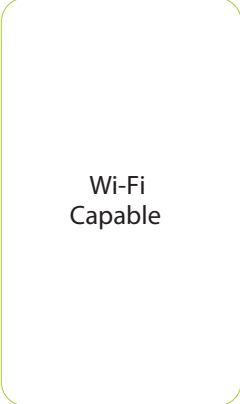
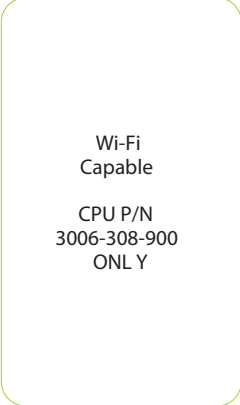
Part Name/Number	Product Label
WiFi Capable 3006-508-105	 <p>Wi-Fi Capable</p>
WiFi CPU Cover 3006-300-105	 <p>Wi-Fi Capable CPU P/N 3006-308-900 ONLY</p>

Recycling Passport

Assembly Part number: 3006-375-895 (Reference Only)

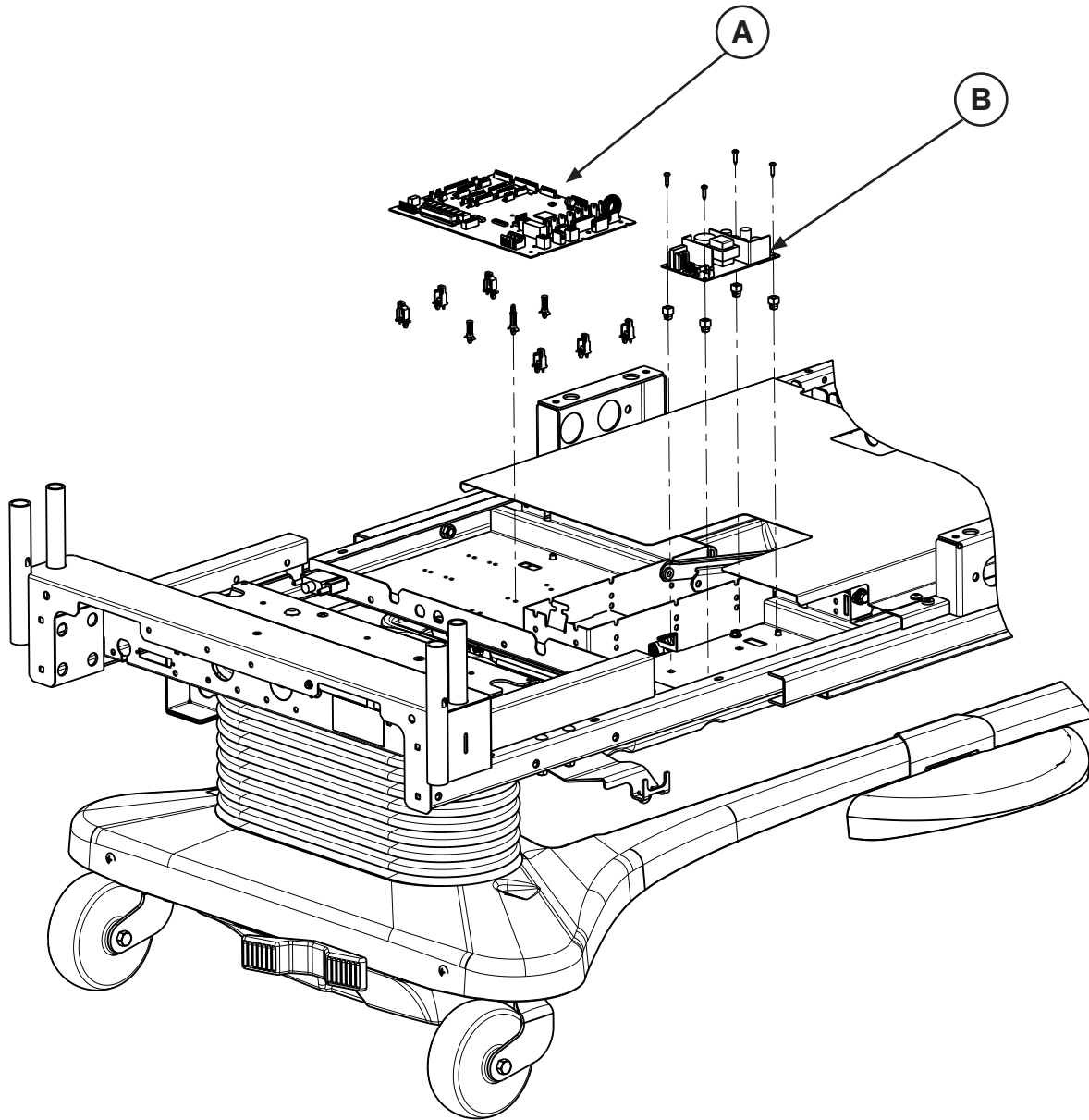

Item	Recycling/Material Code	Important Information	Qty
A	(3006-308-900) CPU Board		1
B	(0059-157-000) Power Supply		1

[Return To Table of Contents](#)

Recycling Passport

Assembly Part number: 3006-300-010 (Reference Only)

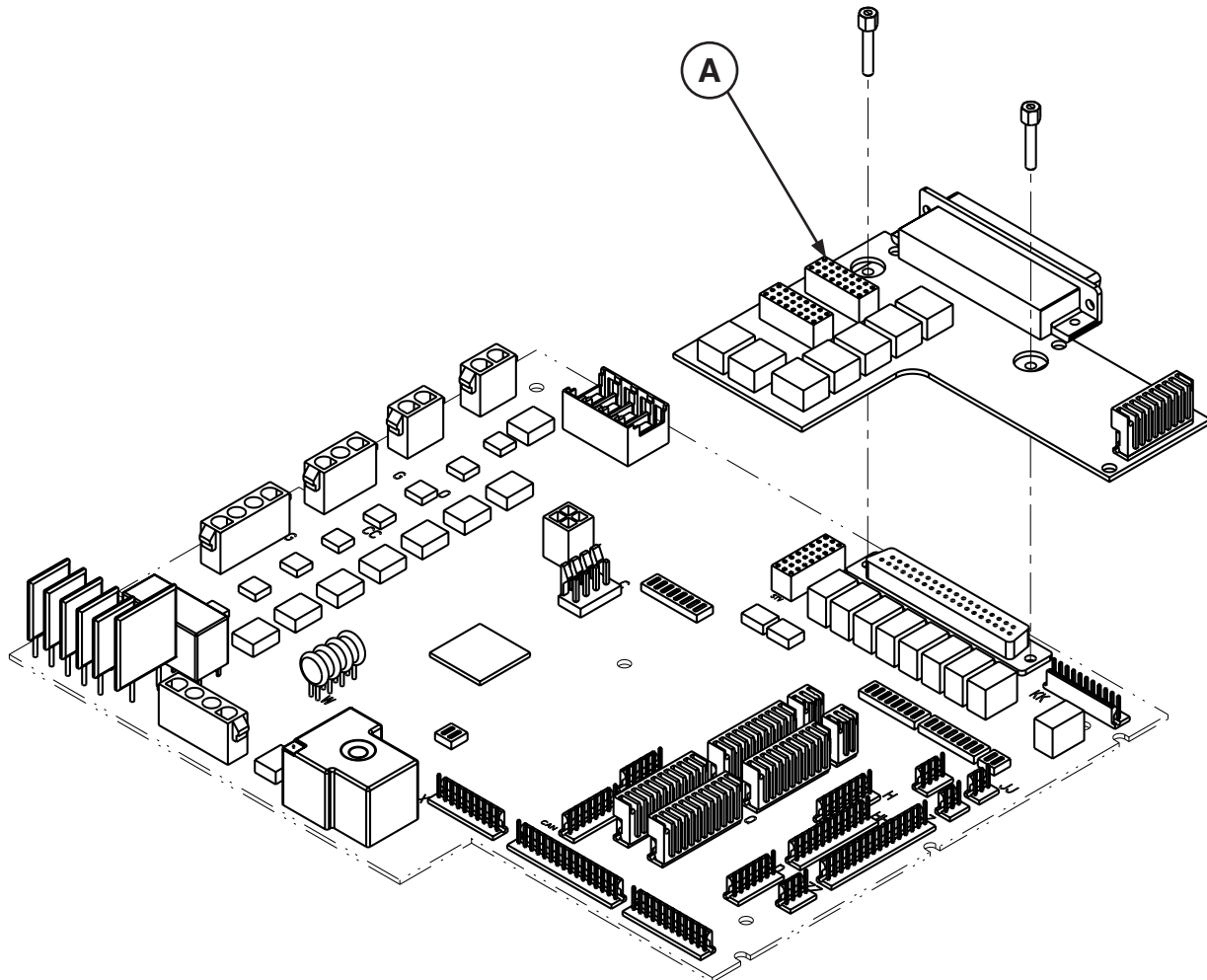

Item	Recycling/Material Code	Important Information	Qty
A	(3006-303-900) 37-Pin Plugover Board		1

Recycling Passport

Assembly Part number: 3006-400-125 (Reference Only)

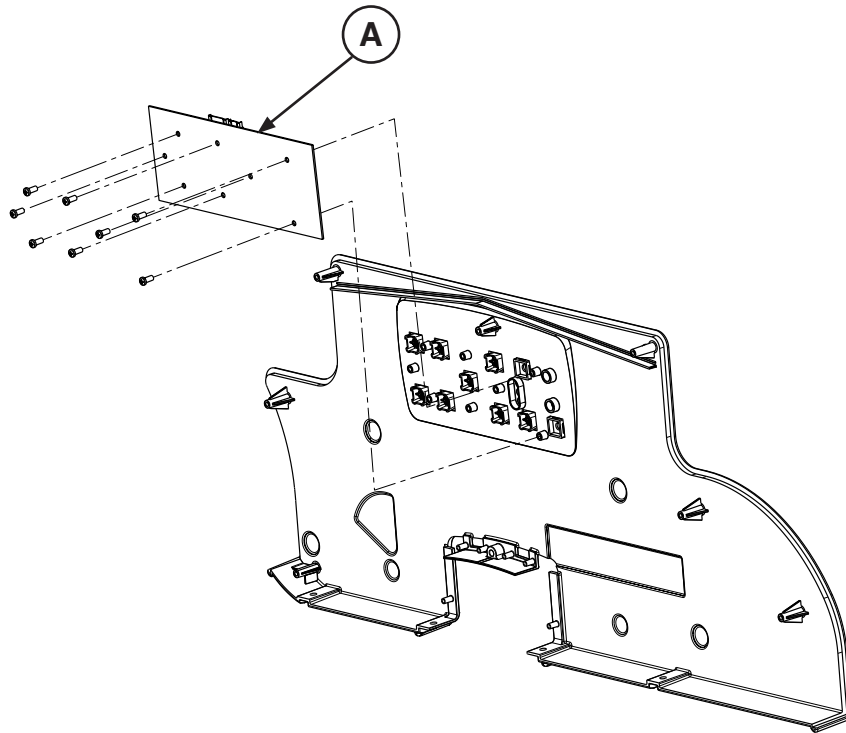

Assembly Part number: 3006-400-225 (Reference Only)

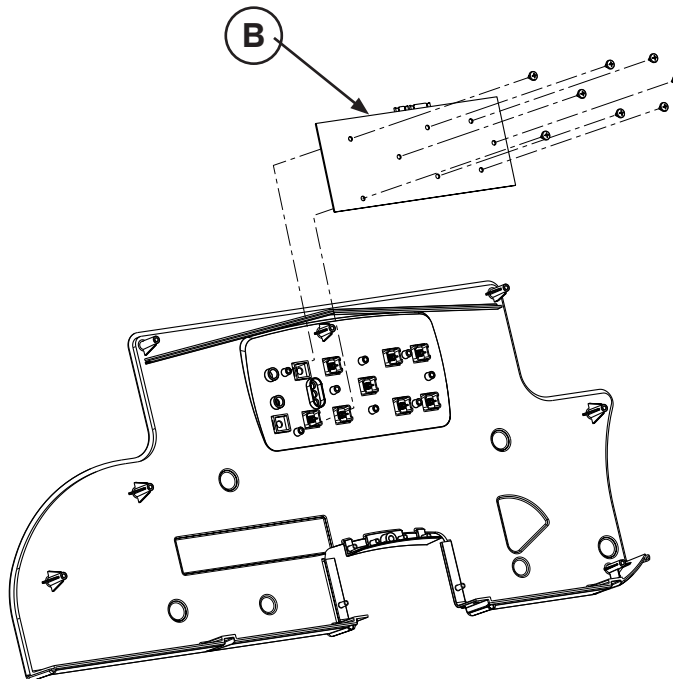

Item	Recycling/Material Code	Important Information	Qty
A	(3006-400-920) Siderail Outer PCB, Left		1
B	(3001-400-910) Siderail Outer PCB, Right		1

[Return To Table of Contents](#)

Recycling Passport

Assembly Part number: 3006-400-130 (Reference Only)

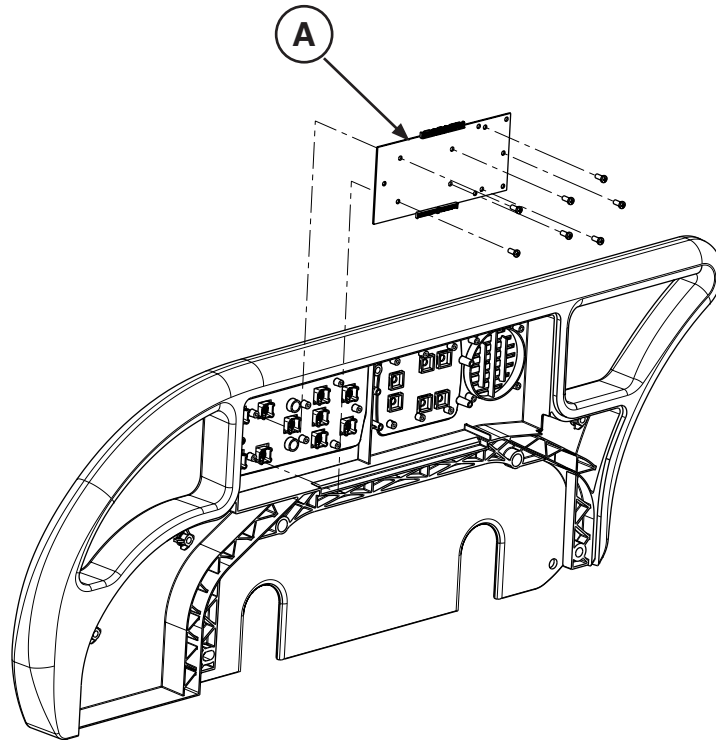

Assembly Part number: 3006-400-230 (Reference Only)

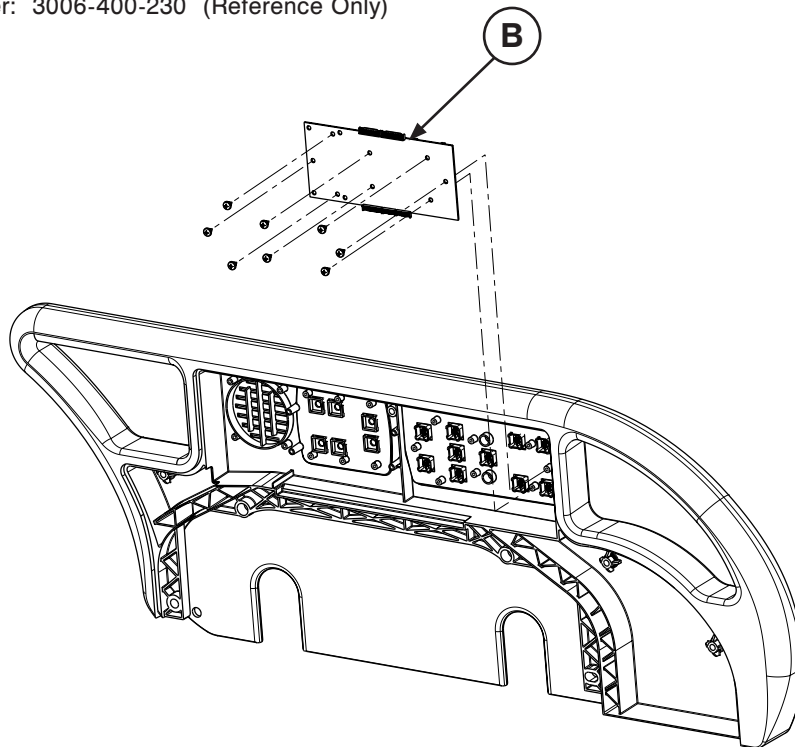

Item	Recycling/Material Code	Important Information	Qty
A	(3006-400-930) Siderail Outer PCB, Left		1
B	(3006-400-930) Siderail Outer PCB, Right		1

Recycling Passport

Assembly Part number: 3006-200-004 (Reference Only)

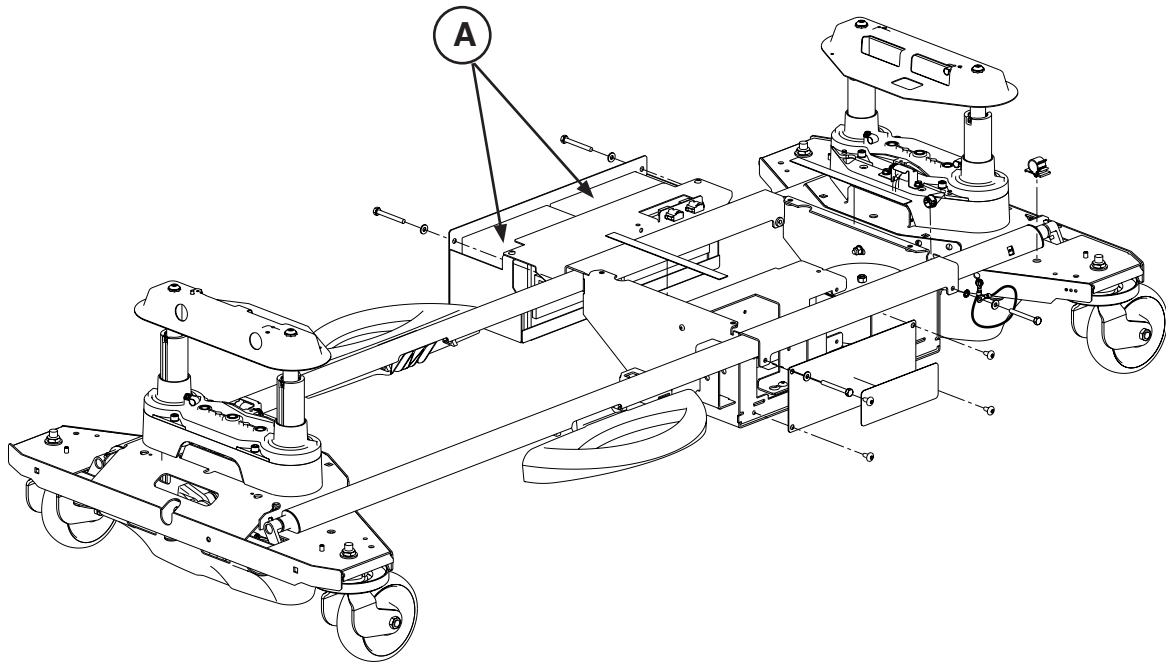

Item	Recycling/Material Code	Important Information	Qty
A	(2040-001-070) Battery 12V		2

Recycling Passport

Assembly Part number: 3006-303-045 (Reference Only)

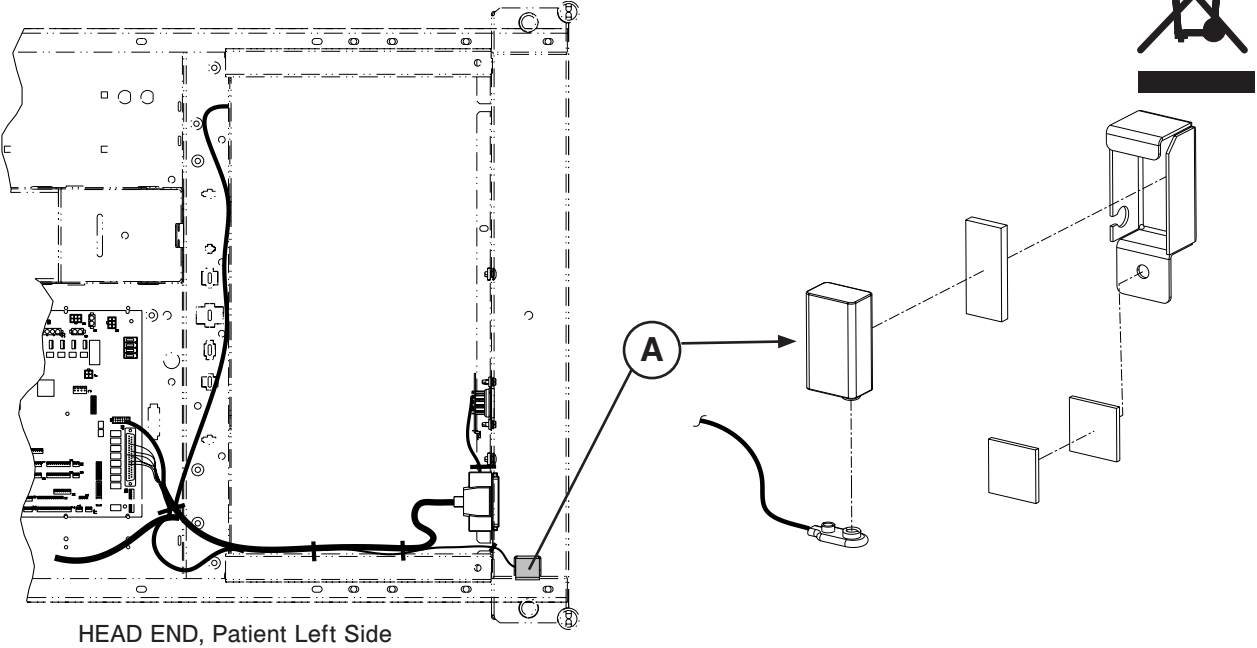

Item	Recycling/Material Code	Important Information	Qty
A	(3000-303-871) Battery 9V		1

Recycling Passport

Assembly Part number: 3001-314-012 (Reference Only)

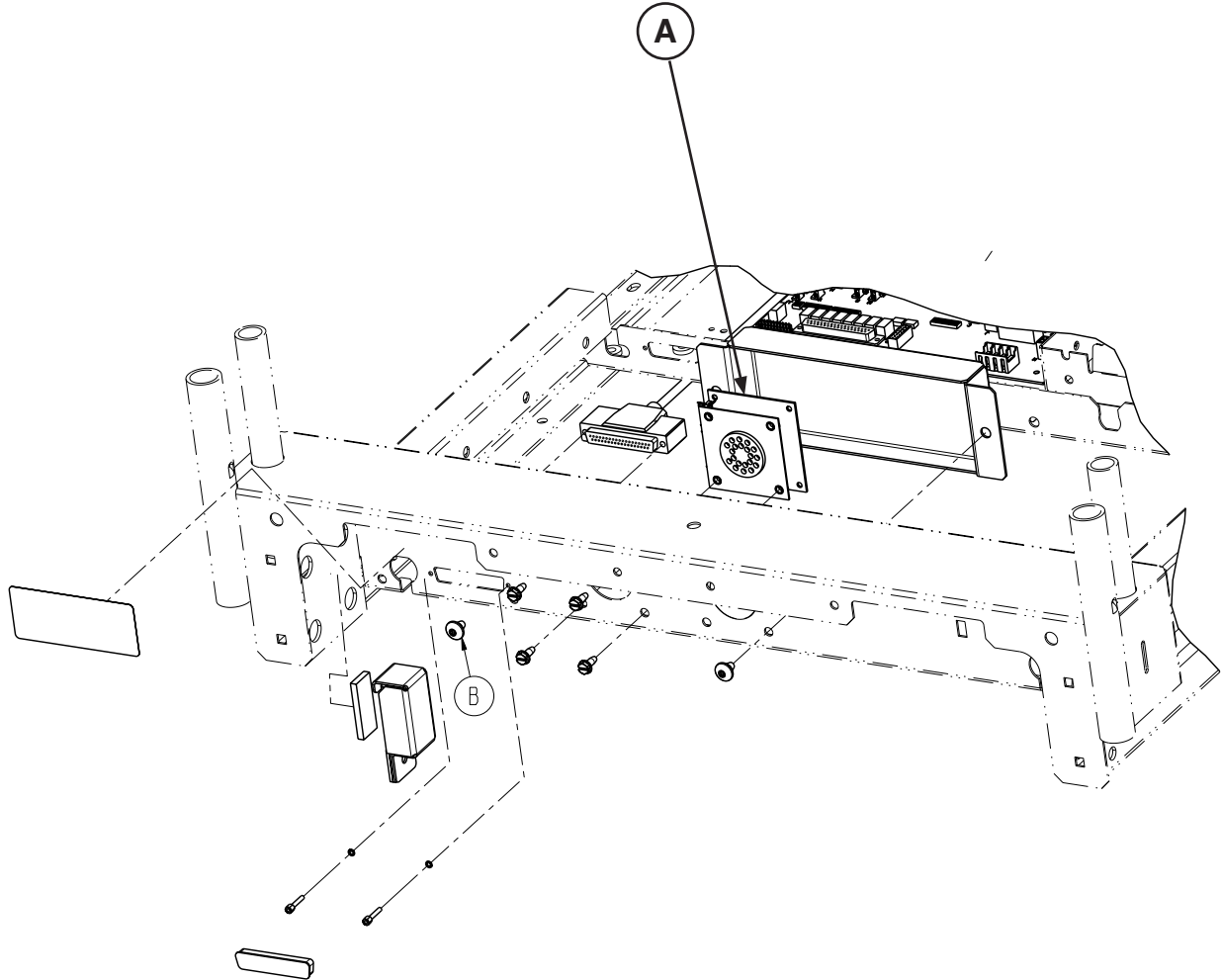

Item	Recycling/Material Code	Important Information	Qty
A	(3001-314-920) Pendant Port PCB		1

Recycling Passport

Assembly Part number: 3006-501-011 (Reference Only)

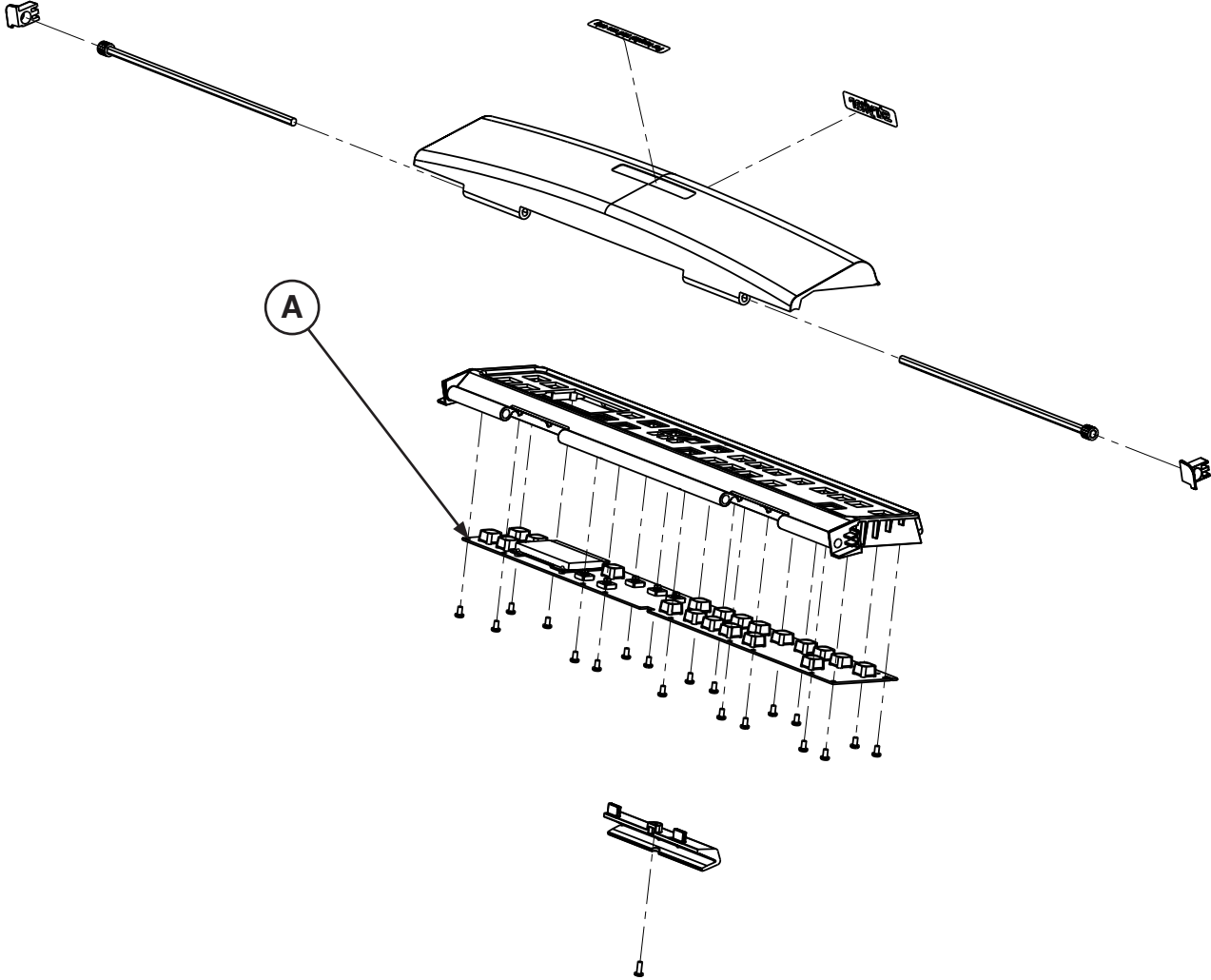

Item	Recycling/Material Code	Important Information	Qty
A	(3006-501-900) Footboard PCB		1

Recycling Passport

Assembly Part number: 5212-300-053 (Reference Only)

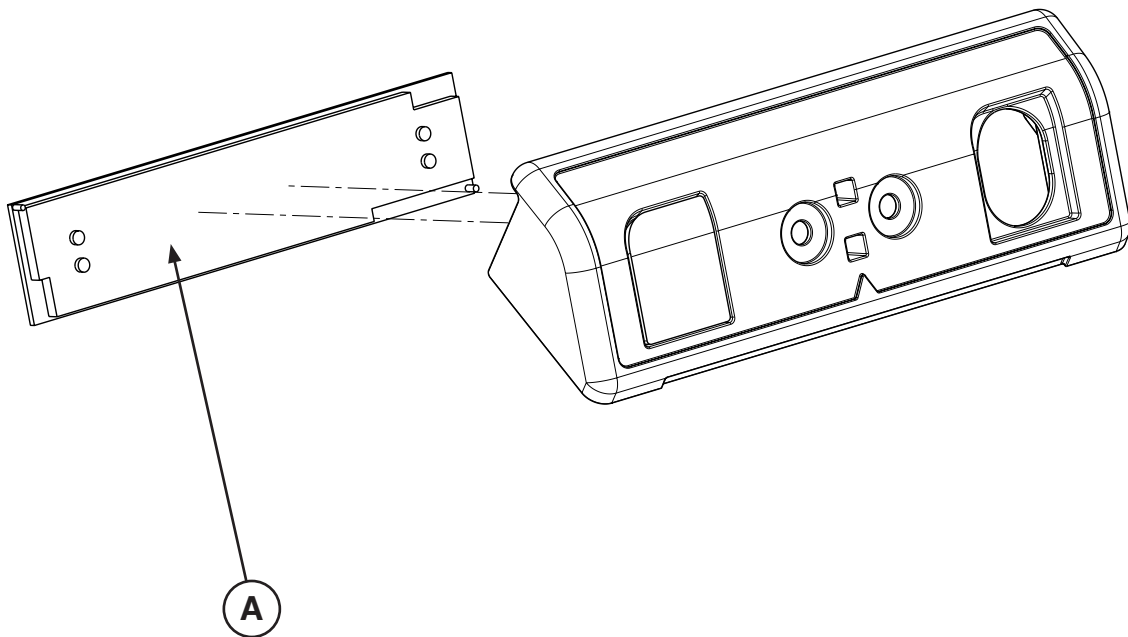

Item	Recycling/Material Code	Important Information	Qty
A	(5212-300-930) IR Module PCB Assembly		1

Recycling Passport

Assembly Part number: 5212-300-012 (Reference Only)

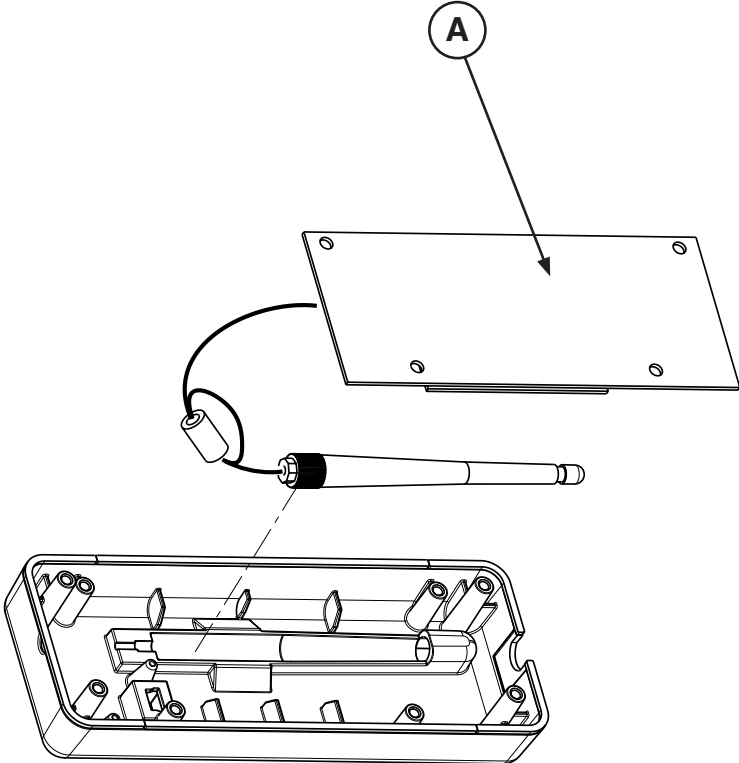

Item	Recycling/Material Code	Important Information	Qty
A	(5212-300-910) Wireless Module PCB Assembly		1

EMC Information

S3® MEDSURG BED, MODEL 3002

Guidance and Manufacturer's Declaration - Electromagnetic Immunity			
The S3® MedSurg Bed, Model 3002 is suitable for use in the electromagnetic environment specified below. The customer or the user of the S3® MedSurg Bed, Model 3002 should assure that it is used in such an environment.			
Immunity Test	IEC 60601 Test Level	Compliance Level	Electromagnetic Environment Guidance
Electrostatic Discharge (ESD) IEC 61000-4-2	+6 kV contact +8 kV air	+6 kV contact +8 kV air	Floors should be wood, concrete, or ceramic tile. If floors are covered with synthetic material, the relative humidity should be at least 30%.
Electrostatic fast Transient/burst IEC 61000-4-4	+2 kV for power supply lines +1 kV for input/output lines	+2 kV for power supply lines +1 kV for input/output lines	Main power quality should be that of a typical commercial or hospital environment.
Surge IEC 61000-4-5	+8 kV differential mode +2 kV common mode	+8 kV differential mode +2 kV common mode	Main power quality is that of a typical commercial and/or hospital environment.
Voltage dips, voltage variations and short interruptions on power supply input lines IEC 61000-4-11	<5%Ut (95% dip in Ut) for 0.5 cycle 40%Ut (60% dip in Ut) for 5 cycles 70%Ut (30% dip in Ut) for 25 cycles. <5% Ut (>95% dip in Ut) for 5 sec.	<5%Ut (95% dip in Ut) for 0.5 cycle 40%Ut (60% dip in Ut) for 5 cycles 70%Ut (30% dip in Ut) for 25 cycles. <5% Ut (>95% dip in Ut) for 5 sec.	Main power quality should be that of a typical commercial and/or hospital environment. If the user of the S3® MedSurg Bed, Model 3002 requires continued operation during power main interruptions, it is recommended that the device be powered from an uninterrupted power supply or a battery.
Power frequency (50/60 Hz) magnetic field IEC 61000-4-8	3 A/m	3 A/m	Power frequency magnetic fields should be at levels characteristic of a typical location in a typical commercial and/or hospital environment.
Note: U_T is the a.c. mains voltage prior to applications of the test level.			

EMC Information

S3® MEDSURG BED, MODEL 3002 (CONTINUED)

Recommended separation distances between portable and mobile RF communications equipment and the S3® MedSurg Bed, Model 3002.			
<p>The S3® MedSurg Bed, Model 3002 is intended for use in an electromagnetic environment in which radiated RF disturbances are controlled. The customer or the user of the S3® MedSurg Bed, Model 3002 can help prevent electromagnetic interferences by maintaining a minimum distance between portable and mobile RF communications equipment (transmitters) and the S3® MedSurg Bed, Model 3002 as recommended below, according to the maximum output power of the communications equipment.</p>			
Rated maximum output power of transmitter W	Separation distance according to frequency of transmitter		
	m		
	150 kHz to 80 MHz $d=1.2 \sqrt{P}$	80 MHz to 800 MHz $d=1.2 \sqrt{P}$	8000 MHz to 2.5 GHz $d=2.3 \sqrt{P}$
0.01	1.12	0.12	0.23
0.1	0.38	0.38	0.73
1	1.2	1.2	2.3
10	3.8	3.8	7.3
100	12	12	23
<p>For transmitters rated at a maximum output power not listed above, the recommended separation distance d in meters (m) can be estimated using the equation applicable to the frequency of the transmitter, where P is the maximum output power rating of the transmitter in watts (W) according to the transmitter manufacturer.</p> <p>Note 1 At 80 MHz and 800 MHz, the separation distance for the higher frequency range applies.</p> <p>Note 2 These guidelines may not apply in all situations. Electromagnetic propagation is affected by absorption and reflection from structures, objects and people.</p>			

EMC Information

S3® MEDSURG BED, MODEL 3002 (CONTINUED)

The S3® MedSurg Bed, Model 3002 is suited for use in the electromagnetic environment specified below. The customer or the user of the S3® MedSurg Bed, Model 3002 should assure that it is used in such an environment.

Immunity Test	IEC 60601 Test Level	Compliance Level	Electromagnetic Environment - Guidance
<p style="text-align: center;">Conducted RF IEC 61000-4-6</p> <p style="text-align: center;">Radiated RF IEC 61000-4-3</p>	<p style="text-align: center;">3 Vrms 150 kHz to 80 MHz</p> <p style="text-align: center;">3 V/m 80 MHz to 2.5 GHz</p>	<p style="text-align: center;">3 Vrms</p> <p style="text-align: center;">3 V/m</p>	<p>Portable and mobile RF communications equipment should be used no closer to any part of the S3® MedSurg Bed, Model 3002, including cables, than the recommended separation distance calculated from the equation appropriate for the frequency of the transmitter.</p> <p style="text-align: center;">Recommended Separation Distance</p> <p style="text-align: center;">$d=1.2 \sqrt{P}$</p> <p style="text-align: center;">$d=1.2 \sqrt{P}$</p> <p style="text-align: center;">$d=2.3 \sqrt{P}$ 800 MHz to 2.5 GHz</p> <p>where P is the maximum output power rating of the transmitter in watts (W) according to the transmitter manufacturer and d is the recommended separation distance in metres (m).</p> <p>Field strengths from fixed RF transmitters, as determined by an electromagnetic site survey,^a should be less than the compliance level in each frequency range.^b</p> <p>Interference may occur in the vicinity of equipment marked with the following symbol:</p> <div style="text-align: center;">  </div>

Note 1

At 80 MHz and 800 MHz, the higher frequency range applies.

Note 2

These guidelines may not apply in all situations. Electromagnetic propagation is affected by absorption and reflection from structures, objects and people.

^aField strengths from fixed transmitters, such as base stations for radio (cellular/cordless) telephones and land mobile radios, amateur radio, AM and FM radio broadcast, and TV broadcast cannot be predicted theoretically with accuracy. To assess the electromagnetic environment due to fixed RF transmitters, an electromagnetic site survey should be considered. If the measured field strength in the location in which the S3® MedSurg Bed, Model 3002 is used exceeds the applicable RF compliance level above, the S3® MedSurg Bed, Model 3002 should be observed to verify normal operation. If abnormal performance is observed, additional measures may be necessary, such as reorienting or relocating the S3® MedSurg Bed, Model 3002.

^bOver the frequency range 150 kHz to 80 MHz, field strengths are less than 3 V/m.

[Return To Table of Contents](#)

EMC Information

S3[®] MEDSURG BED, MODEL 3002 (CONTINUED)

Guidance and Manufacturer's Declaration - Electromagnetic Emissions		
<p>The S3[®] MedSurg Bed, Model 3002 is intended for use in an electromagnetic environment specified below. The customer or the user of the S3[®] MedSurg Bed, Model 3002 should assure that it is used in such an environment.</p>		
Emissions Test	Compliance	Electromagnetic Environment
RF Emissions CISPR 11	Group 1, without <i>i</i> Bed [®] Wireless option Group 2, with <i>i</i> Bed [®] Wireless option	The S3 [®] MedSurg Bed, Model 3002 uses RF energy only for its internal function. Therefore, its RF emissions are very low and are not likely to cause any interference in nearby electronic equipment.
RF Emissions CISPR 11	Class A	The S3 [®] MedSurg Bed, Model 3002 is suitable for use in all establishments other than domestic and those directly connected to the public low voltage power supply network that supplies buildings used for domestic purposes.
Harmonic Emissions IEC 61000-3-2	Class A	
Voltage Fluctuations Flicker Emissions IEC 61000-3-3	Complies	

Warranty

LIMITED WARRANTY

Stryker Medical Division, a division of Stryker Corporation, warrants to the original purchaser the S3[®] MedSurg Bed, Model 3002 to be free from defects in material and workmanship for a period of one (1) year after date of delivery. Stryker's obligation under this warranty is expressly limited to supplying replacement parts and labor for, or replacing, at its option, any product which is, in the sole discretion of Stryker, found to be defective. If requested by Stryker, products or parts for which a warranty claim is made shall be returned prepaid to the factory. Any improper use or any alteration or repair by others in such manner as in Stryker's judgment affects the product materially and adversely shall void this warranty. Any repair of Stryker products using parts not provided or authorized by Stryker shall void this warranty. No employee or representative of Stryker is authorized to change this warranty in any way.

Stryker Medical Bed products are designed for a 10 year expected service life under normal use, conditions, and with appropriate periodic maintenance as described in the maintenance manual for each device. Stryker warrants to the original purchaser that the welds on its Bed products will be free from structural defects for the expected 15-year life of the Bed product as long as the original purchaser owns the product.

Stryker Medical optional components and/or accessories are warranted as follows:

- Motion/Nurse Call Pendant: Two (2) years service life under normal use and proper care
- Motion/Nurse Call/SmartTV Pendant: Two (2) years service life under normal use and proper care
- iBed[®] Wireless Components: Ten (10) years service life under normal use and proper care

WARRANTY EXCLUSION AND DAMAGE LIMITATIONS

The express warranty set forth herein is the only warranty applicable to the product. Any and all other warranties, whether express or implied, including any implied warranty of merchantability or fitness for a particular purpose are expressly excluded by Stryker. In no event shall Stryker be liable for incidental or consequential damages.

TO OBTAIN PARTS AND SERVICE

Stryker products are supported by a nationwide network of dedicated Stryker Field Service Representatives. These representatives are factory trained, available locally, and carry a substantial spare parts inventory to minimize repair time. Simply call your local representative or call Stryker Customer Service at 1-800-327 -0770.

RETURN AUTHORIZATION

Product cannot be returned without prior approval from the Stryker Customer Service Department. An authorization number will be provided which must be printed on the returned product. Stryker reserves the right to charge shipping and restocking fees on returned product. Special, modified, or discontinued products are not subject to return.

DAMAGED MERCHANDISE

ICC Regulations require that claims for damaged product must be made with within fifteen (15) days of receipt of the product. Do not accept damaged shipments unless such damage is noted on the delivery receipt at the time of receipt. Upon prompt notification, Stryker will file a freight claim with the appropriate carrier for damages incurred. Claims will be limited in amount to the actual replacement cost. In the event that this information is not received by Stryker within the fifteen (15) day period following the delivery of the product, or the damage was not noted on the delivery receipt at the time of receipt, the customer will be responsible for payment of the original invoice in full within thirty (30) days of receipt. Claims for any incomplete shipments must be made within thirty (30) days of invoice.

INTERNATIONAL WARRANTY CLAUSE

This warranty reflects U.S. domestic policy. Warranty outside the U.S. may vary by country. Contact your local Stryker Medical representative for additional information.



Stryker Medical
3800 E. Centre Avenue
Portage, MI 49002
USA

stryker[®]