

## Secure® Connect

Operations/Maintenance Manual

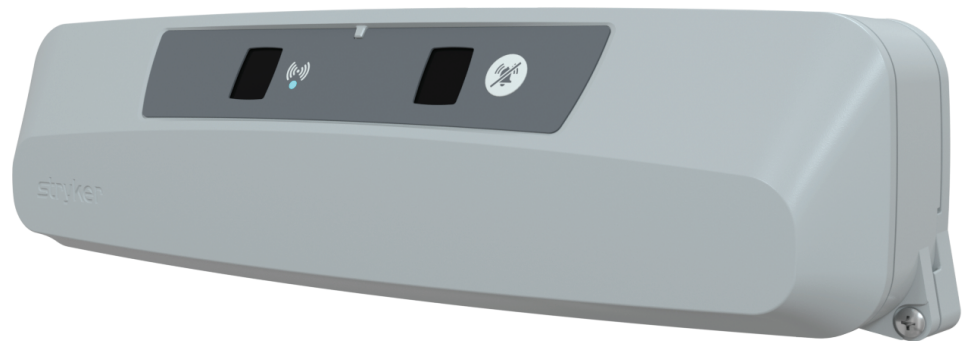

















REF 521200380100





Connected Hospital®





# Symbols

	Refer to instruction manual/booklet
	Consult instructions for use
	General warning
	Caution
	Non-ionizing radiation
	China RoHS with declarable substances
	Catalogue number
	Serial number
	European medical device
	CE mark
	UK Conformance Assessment mark
	Importer
	Unique device identifier
	Authorized representative in the European Community
	Authorized representative in Switzerland
	For US Patents see <a href="http://www.stryker.com/patents">www.stryker.com/patents</a>
	Manufacturer
	Date of manufacture

IPX4	Protection from liquid splash
	Class II electrical equipment: equipment in which protection against electric shock does not rely on basic insulation only, but in which additional safety precautions such as double insulation or reinforced insulation are provided, there being no provision for protective earthing or reliance upon installation conditions.
	Medical Equipment Classified by Underwriters Laboratories Inc. With Respect to Electric Shock, Fire, and Mechanical Hazards Only in Accordance with ANSI/AAMI ES60601-1:2005/(R)2012 and A1:2012 C1:2009/(R)2012 and A2:2010/(R)2012, CAN/CSA-C22.2 No. 60601-1:14, IEC 60601-2-52:2009/A1:2015, CAN/CSA-C22.2 No. 60601-2-52:11 with Amendment 1:2017.
	South Africa Wireless Conformity mark
	Mexico Wireless Conformity mark (NOM)
	In accordance with European Directive 2012/19/EU on Waste Electrical and Electronic Equipment (WEEE) as amended, this symbol indicates that the product should be collected separately for recycling. Do not dispose of as unsorted municipal waste. Contact local distributor for disposal information. Ensure infected equipment is decontaminated prior to recycling.

# Table of Contents

Warning/Caution/Note Definition .....	2
Summary of safety precautions .....	2
Introduction .....	3
Product description .....	3
Contraindications .....	3
Expected service life .....	3
Disposal/recycle .....	3
Specifications .....	3
Bluetooth radio specifications .....	4
Contact information .....	5
Serial number location .....	5
Installation .....	6
Installing <b>Secure Connect</b> .....	6
Installation checklist .....	9
Operation .....	10
<b>Secure Connect</b> indicators/functions .....	10
Configuring the <b>Secure Connect</b> .....	11
Testing the <b>Secure Connect</b> .....	12
Preventive maintenance .....	13
Cleaning and disinfecting with SideKick® .....	14
Cleaning .....	15
Disinfecting .....	16
Wireless notifications .....	17
EMC information .....	19
<b>Secure Connect</b> association form .....	23

# Warning/Caution/Note Definition

The words **WARNING**, **CAUTION**, and **NOTE** carry special meanings and should be carefully reviewed.

## **WARNING**

Alerts the reader about a situation which, if not avoided, could result in death or serious injury. It may also describe potential serious adverse reactions and safety hazards.

## **CAUTION**

Alerts the reader of a potentially hazardous situation which, if not avoided, may result in minor or moderate injury to the user or patient or damage to the product or other property. This includes special care necessary for the safe and effective use of the device and the care necessary to avoid damage to a device that may occur as a result of use or misuse.

**Note** - Provides special information to make maintenance easier or important instructions clearer.

## Summary of safety precautions

Always read and strictly follow the warnings and cautions listed on this page. Service only by qualified personnel.

---

### **WARNING**

- Portable RF communications equipment, including peripherals such as antenna cables and external antennas, should be no closer than 12 inches (30 cm) to any part of the **Secure Connect** locator, including cables specified by the manufacturer.
  - Avoid stacking or placing equipment adjacent with other equipment to prevent improper operation of the product. If such use is necessary, carefully observe stacked or adjacent equipment to make sure that they operate properly.
  - The use of accessories, transducers, and cables, other than those specified or provided by the manufacturer, could result in increased electromagnetic emissions or decreased electromagnetic immunity and result in improper operation.
- 

### **CAUTION**

- Improper usage of the product can cause injury to the patient or operator. Operate the product only as described in this manual.
  - Do not modify the product or any components of the product. Modifying the product can cause unpredictable operation resulting in injury to patient or operator. Modifying the product also voids its warranty.
  - Always match the dip-switches on SB1 and SB2 to the connected product configuration to avoid the risk of head wall damage.
  - Always match the dip-switches of a product to the head wall configuration if a nurse call communication cable needs to be connected to avoid the risk of head wall damage.
  - Always match the dip-switches on SB1 and SB2 to the product configuration to avoid the risk of head wall damage.
  - Do not clean, disinfect, service, or perform maintenance while the product is in use.
  - Always unplug the power cord from the wall outlet when large spills occur near the circuit boards and cables. Clean up the fluid, and inspect the product. Fluids can cause unpredictable operation and decreased functionality of any electrical product. Do not return the product to service until dry and tested for safe operation.
  - Always wipe down with clean water (or 70% isopropyl alcohol, if using **Virex® TB**) and dry each product after disinfecting. Some disinfectants are corrosive in nature and may cause damage to the product. If you do not rinse and dry the product, you may leave a corrosive residue on the surface of the product. This corrosive residue could cause premature degradation of critical components. Failure to follow these disinfecting instructions may void your warranty.
-

# Introduction

This manual assists you with the operation or maintenance of your Stryker product. Read this manual before operating or maintaining this product. Set methods and procedures to educate and train your staff on the safe operation or maintenance of this product.

---

## CAUTION

- Improper usage of the product can cause injury to the patient or operator. Operate the product only as described in this manual.
  - Do not modify the product or any components of the product. Modifying the product can cause unpredictable operation resulting in injury to patient or operator. Modifying the product also voids its warranty.
- 

## Note

- This manual is a permanent part of the product and should remain with the product even if the product is sold.
- Stryker continually seeks advancements in product design and quality. This manual contains the most current product information available at the time of printing. There may be minor discrepancies between your product and this manual. If you have any questions, contact Stryker Customer Service or Technical Support at 1-800-327-0770.

## Product description

The Stryker Model 521200380100 **Secure® Connect** is a cable-free nurse call solution. **Secure Connect** allows for patient nurse communication via the nurse call button, room controls, and TV controls without the need for any cables or wires.

## Contraindications

None known.

## Expected service life

The **Secure Connect** has a 10 year expected service life under normal use conditions and with appropriate periodic maintenance.

The battery has a two year expected service life under normal use conditions.

## Disposal/recycle

Always follow the current local recommendations and/or regulations governing environmental protection and the risks associated with recycling or disposing of the equipment at the end of its useful life.

## Specifications

Length	16.3 in.	41.1 cm
Width	3.3 in.	8.4 cm
Depth	4.3 in.	10.9 cm
Weight	4 lb	1.8 kg

System voltage rating	AC supply: 100-240 VAC, 50/60 Hz, 0.8A
	<b>Secure Connect:</b> 18 VDC, 1.67A
Wireless connection	<p>Uses infrared (IR) LED and Bluetooth based on Stryker proprietary communication scheme</p> <p><b>Note</b> - Minimum signal strength of the <b>Secure Connect</b> must be within 3dB of the connected product. Make sure the product is within 5.5 ft (1.7 m) of the <b>Secure Connect</b>.</p>

Stryker reserves the right to change specifications without notice.

Specifications listed are approximate and may vary slightly from product to product or by power supply fluctuations.

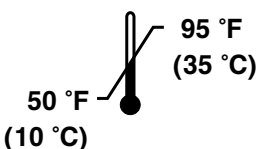
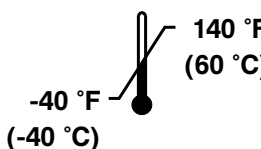
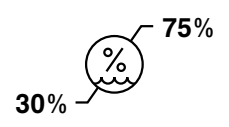
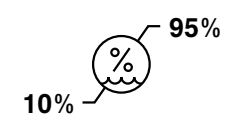
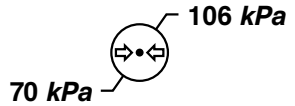
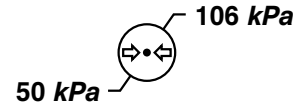
Environmental conditions	Operation	Storage and transportation
Ambient temperature		
Relative humidity (non-condensing)		
Atmospheric pressure		

In accordance with the European REACH regulation and other environmental regulatory requirements, the components that contain declarable substances are listed.

Description	Number	Substance of very high concern (SVHC) chemical name
Wallside room interface board	521200380950	Decamethylcyclopentasiloxane, dodecamethylcyclohexasiloxane, lead, octamethylcyclotetrasiloxane

## Bluetooth radio specifications

Item	Specification - Chipset WT32i (Silicon Labs)			Unit
	Channel	Min	Max	
Operating frequencies	79	2.4	2.4835	GHz
Receiving bandwidth	Not applicable	1		MHz
Maximum ERP	Not applicable	-24.148		dBW



## Contact information

Contact Stryker Customer Service or Technical Support at: 1-800-327-0770.

Stryker Medical  
3800 E. Centre Avenue  
Portage, MI 49002  
USA

**Note** - The user and/or the patient should report any serious product-related incident to both the manufacturer and the Competent authority of the European Member State where the user and/or patient is established.

To view your operations or maintenance manual online, see <https://techweb.stryker.com/>.

Have the serial number (A) of your Stryker product available when calling Stryker Customer Service or Technical Support. Include the serial number in all written communication.

## Serial number location

The Stryker serial number and bed bay identification number (BBID) label (A) is located on the bottom of the product (Figure 1).

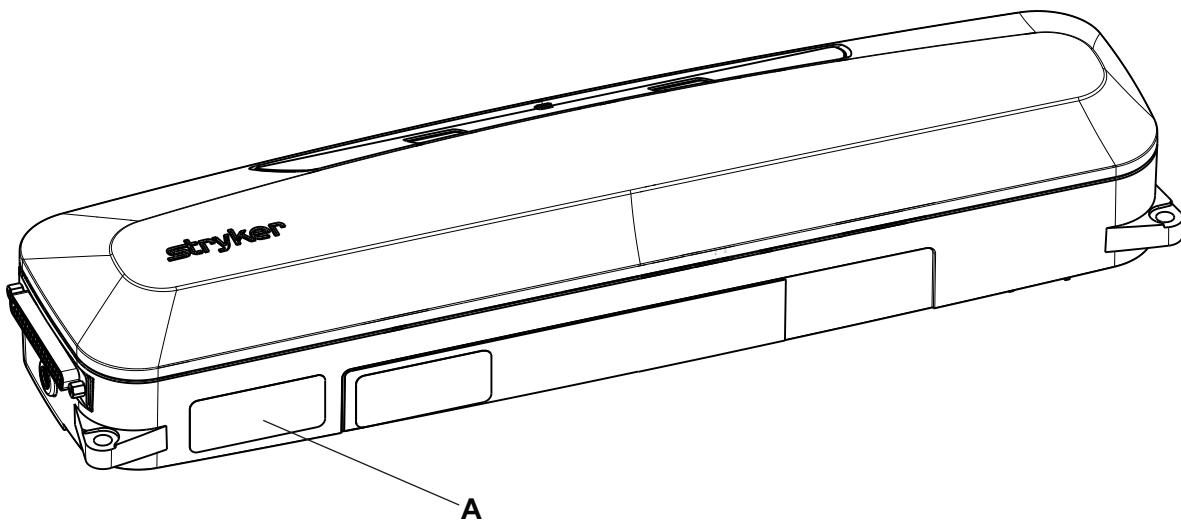

Figure 1 – Stryker serial number and BBID location

# Installation

## Installing Secure Connect

### Tools required:

- #2 Phillips screwdriver
- #1 Phillips screwdriver
- Straight pick
- Tape measure
- Level
- Pencil
- Tools required for hospital supplied fasteners

### Procedure:

1. Record the **Secure Connect** BBID (*Serial number location* (page 5)) and room number/patient position on the **Secure Connect association form** (page 23).
2. Using a straight pick, configure the SB1 and SB2 dip-switches (A) to match the nurse call system and nurse call communication cable (Figure 2).

---

**CAUTION** - Always match the dip-switches on SB1 and SB2 to the connected product configuration to avoid the risk of head wall damage.

---

**Note** - To confirm dip-switch configuration, contact Stryker customer service or technical support (*Contact information* (page 5)).

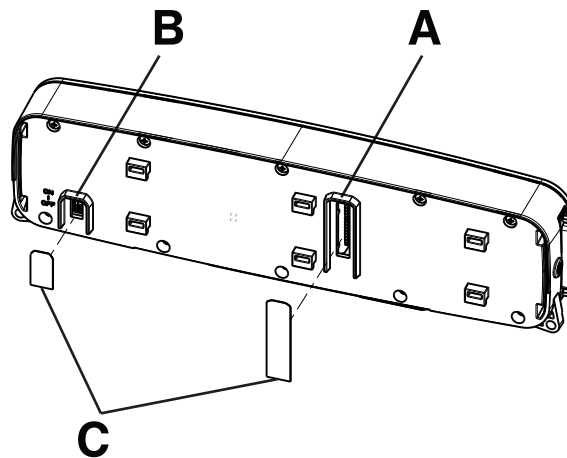
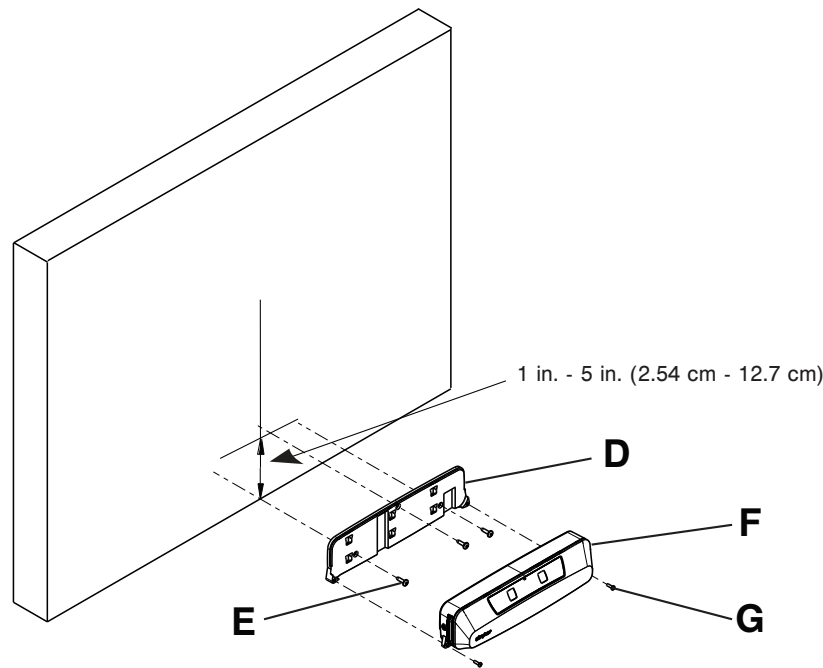

Figure 2 – Switch configuration

3. Using a straight pick, turn the **Secure Connect ON/OFF** switch (B) to the **ON** position (Figure 2).
4. Affix the two supplied IPX labels (C) over the dip-switch and the **ON/OFF** cutouts located on the back of the **Secure Connect** (Figure 2).
5. Using a tape measure and pencil, mark the intended center of the bed location (vertical line) (Figure 3).



**Figure 3 – Mounting specifications**

6. Center the mounting plate on the vertical line made in step 5 and mount the bottom of the mounting plate max 1 in. (2.54 cm) off the floor (Figure 3).

**Note**

- Do not mount on a baseboard if the baseboard thickness exceeds 1 in. (2.54 cm).
- You may mount the bottom of the mounting plate up to 5 in. from the floor if you can always maintain a distance of at least 5 in. between the head end of the bed and the wall. Consider use of a floor threshold or roller bumpers.

7. Using a level on the bottom of the mounting plate (D), make sure that the bottom of the mounting plate (D) is level when you position the mounting plate (D) on the reference marks made in steps 5 and 6 (Figure 3).
8. Use a pencil to mark the three screw holes of the mounting plate (D).
9. Using the appropriate tool with the hospital supplied fasteners (E, not included), secure the mounting plate (D) to the wall (Figure 3).
10. Attach the **Secure Connect** (F) to the mounting plate (D) (Figure 3).
11. Using a #2 Phillips screwdriver, secure the **Secure Connect** (F) to the mounting plate (D) with the two supplied screws (700001126359) (G) (Figure 3).
12. Plug the **Secure Connect** power supply into a hospital grade protective earthed wall outlet.

**Note** - Position the power supply in an accessible location.

13. On the **Secure Connect**, plug in the female end of the power supply.
14. On the **Secure Connect**, plug in the nurse call communication cable.
15. Using a #1 Phillips screwdriver, secure the nurse call communication cable to the **Secure Connect**.
16. Connect and secure the nurse call communication cable to the nurse call system wall plug.
17. See *Configuring the Secure Connect* (page 11).
18. Follow the procedure in the product manual to connect the product to the **Secure Connect**.

---

**CAUTION** - Always match the dip-switches of a product to the head wall configuration if a nurse call communication cable needs to be connected to avoid the risk of head wall damage.

---

**Note**

- If a **Secure Connect** is moved, repeat steps 1 and 10-17.

- If a product is moved to another configured **Secure Connect**, no change needs to be made as the product will connect automatically.

# Installation checklist

Follow this checklist for the 521200380100 **Secure Connect**:

- \_\_\_\_\_ Confirm that you do not have any unused components after installation. Your **Secure Connect** does not ship with any extra components
- \_\_\_\_\_ Check that the **Secure Connect** ID number and room number/location has been recorded on the **Secure Connect association form** (page 23)
- \_\_\_\_\_ Use a tape measure to check that the **Secure Connect** is installed at the horizontal center of the wall behind the bed location
- \_\_\_\_\_ Use a tape measure to check that the bottom of the **Secure Connect** is installed 1 in. - 5 in. (2.54 cm - 12.7 cm) from the floor
- \_\_\_\_\_ Use a level to confirm that the mounting plate is level
- \_\_\_\_\_ All fasteners are tight with no signs of protruding or missing fasteners
- \_\_\_\_\_ Power supply is plugged into a hospital grade protective earthed wall outlet and to the **Secure Connect**
- \_\_\_\_\_ Nurse call communication cable is plugged into the **Secure Connect** and the nurse call system

Product ID number:			
Installed by:		Date:	
Inspected by:		Date:	

**Note** - Maintain a copy of this record for at least 10 years.

# Operation

## Secure Connect indicators/functions

The **Secure Connect** has indicator symbols and a nurse call cord out cancel button (A) that is located on top of the product. This button cancels the alert if the nurse call communication cable is unplugged.



Indicator	Indicator light	Status
	Solid	Connected
	Pulse	Connecting
	Flash	Connection error
	Pulse	AC power unplugged
	Flash	Low battery
	Pulse	Nurse call communication cable unplugged
	Solid	The <b>Secure Connect</b> is not configured
	Flash	Error (reference product display for error detail)
	Flash	Battery error

# Configuring the Secure Connect

## Tools required:

- **Secure Connect** scanner option (521200380700) or **Secure Connect** compatible product
- Stryker service tool option (521205080001)

**Note** - Stryker service tool required if you use the **Secure Connect** scanner.

---

**CAUTION** - Always match the dip-switches on SB1 and SB2 to the product configuration to avoid the risk of head wall damage.

---

## Procedure:

Using the **Secure Connect** scanner:

1. Using the Stryker service tool, select the supplied soft configuration and settings.
2. Select **Save Configuration (A)** (Figure 4).

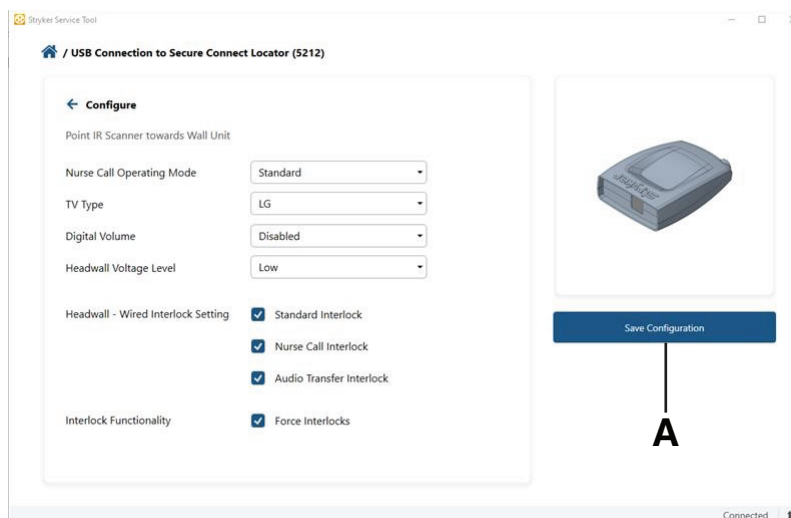



Figure 4 – Stryker service tool

Using a **ProCuity®** bed:

1. Apply the brakes.

**Note** - See the Model 3009 **ProCuity** Operations Manual for steps to apply the brakes.

2. Confirm the **Secure Connect** connection to **ProCuity**.

**Note** - The  icon will appear on the **ProCuity** home screen when **Secure Connect** has connected.

3. Enter the service menu and select **Configuration (B)** (Figure 5).

**Note** - See the Model 3009 **ProCuity** Maintenance Manual for steps to access the service menu.

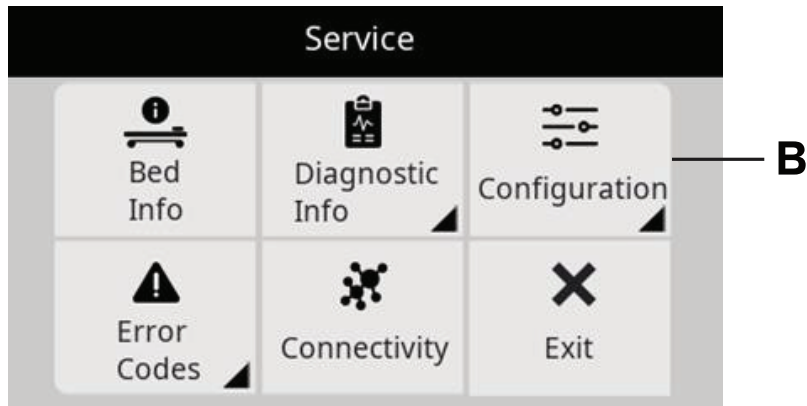

Figure 5 – ProCuity service menu

4. In the configuration menu, select **Room Interface Configuration** (C) (Figure 6).

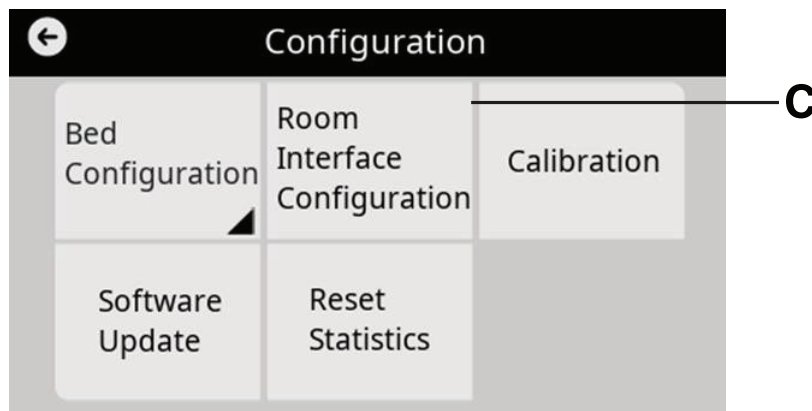

Figure 6 – ProCuity configuration menu

5. Input the supplied settings and select **Save**.

## Testing the Secure Connect

### Tools required:

- **Secure Connect** scanner option (521200380700) or **Secure Connect** compatible product
- Stryker service tool option (521205080001)

**Note** - Stryker service tool required if you use the **Secure Connect** scanner.

### Procedure:

#### Secure Connect scanner:

Using the Stryker service tool test function, activate the nurse call.

#### ProCuity bed:

Using the footboard and siderail control panels, activate the nurse call.

**Note** - See the Model 3009 **ProCuity** Operations Manual for steps to activate nurse call.



# Preventive maintenance

Remove product from service before you perform the preventive maintenance inspection. Check all items listed during annual preventive maintenance for all Stryker Medical products. You may need to perform preventive maintenance checks more often based on your level of product usage. Service only by qualified personnel.

Inspect the following items:

- \_\_\_\_\_ All fasteners are secure
- \_\_\_\_\_ The **Secure Connect** casing is not cracked or damaged
- \_\_\_\_\_ Mounting plate not cracked or damaged
- \_\_\_\_\_ The **Secure Connect** front label is not damaged
- \_\_\_\_\_ Replace the battery (every two years)

Product serial number:
Completed by:
Date:

# Cleaning and disinfecting with SideKick®

For United States only. Confirm availability for your configuration or region. Call Stryker Customer Service: 1-800-327-0770.

Stryker's preferred spray (2070-000-001) and 6" x 10" wipes (2060-000-001) include the following active ingredients:

- n-Alkyl (60% C14, 30% C16, 5% C12, 5% C18) dimethyl benzyl ammonium chloride - 0.154%
- n-Alkyl (68% C12, 32% C14) dimethyl ethylbenzyl ammonium chloride - 0.154%
- Isopropanol - 21.000%

Non-active ingredient: Ethylene Glycol Monobutyl Ether – < 3%

**Note** - For safety information, read the product label.

## To clean or disinfect the external product surface with SideKick wipe:

### To clean:

1. Wipe down the external product surface with a fresh, clean wipe to remove all visible soils.
2. Repeat as necessary until the external product surface is visibly clean.
3. Wipe dry with a cloth or allow the external product surface to air dry before you return the product to service.

**Note** - Use as many wipes as necessary.

### To disinfect:

1. Clean first.
2. Wipe down the external product surface with a fresh, clean wipe until wet.
3. Allow the external product surface to remain wet for two minutes at room temperature.
4. Wipe dry with a cloth or allow the external product surface to air dry before you return the product to service.

## To clean or disinfect the external product surface with SideKick spray:

### To clean:

1. Spray **SideKick** on a mop, sponge, paper cloth, or cloth towel.
2. Wipe down the external product surface with a fresh, clean mop, sponge, paper cloth, or cloth towel to remove all visible soils.
3. Repeat as necessary until the external product surface is visibly clean.
4. Wipe dry with a cloth or allow the external product surface to air dry before you return the product to service.

### To disinfect:

1. Clean first.
2. Spray **SideKick** on a mop, sponge, paper cloth, or cloth towel.
3. Wipe down the external product surface with a fresh, clean mop, sponge, paper cloth, or cloth towel until wet.
4. Allow the external product surface to remain wet for two minutes at room temperature.
5. Wipe dry with a cloth or allow the external product surface to air dry before you return the product to service.

**Note** - Follow your hospital protocols to launder cloth towels or dispose of wipes or paper cloths.

# Cleaning

---

## CAUTION

- Do not clean, disinfect, service, or perform maintenance while the product is in use.
  - Always unplug the power cord from the wall outlet when large spills occur near the circuit boards and cables. Clean up the fluid, and inspect the product. Fluids can cause unpredictable operation and decreased functionality of any electrical product. Do not return the product to service until dry and tested for safe operation.
- 

Recommended cleaning method:

1. Using spray or pre-soaked wipes, hand wash all exposed surfaces of the product with a mild detergent.
2. Follow the cleaning solution manufacturer's instructions for appropriate contact time and rinse requirements.
3. Dry the product before you return it to service.

**Note** - Avoid oversaturation. Do not allow the product to remain wet.

# Disinfecting

---

## CAUTION

- Do not clean, disinfect, service, or perform maintenance while the product is in use.
  - Always unplug the power cord from the wall outlet when large spills occur near the circuit boards and cables. Clean up the fluid, and inspect the product. Fluids can cause unpredictable operation and decreased functionality of any electrical product. Do not return the product to service until dry and tested for safe operation.
  - Always wipe down with clean water (or 70% isopropyl alcohol, if using **Virex® TB**) and dry each product after disinfecting. Some disinfectants are corrosive in nature and may cause damage to the product. If you do not rinse and dry the product, you may leave a corrosive residue on the surface of the product. This corrosive residue could cause premature degradation of critical components. Failure to follow these disinfecting instructions may void your warranty.
- 

Recommended disinfectants for this product's surfaces include:

- Quaternary (active ingredient - ammonium chloride)
- Phenolic (active ingredient - o-phenylphenol)
- Chlorinated bleach solution (10,000 ppm available chlorine, 941 mL of a 5.25% sodium hypochlorite solution per 4000 mL of water)
- Alcohol (active ingredient - 70% isopropyl alcohol)
- Accelerated hydrogen peroxide (5,000 ppm hydrogen peroxide)

Disinfection method:

1. Follow the disinfectant solution manufacturer's dilution recommendations.
2. Using spray or pre-soaked wipes, apply the recommended disinfectant solution.
3. Hand wash all exposed surfaces of the product with the recommended disinfectant.
4. Dry the product before you return it to service.



## Note

- Avoid oversaturation. Do not allow the product to remain wet.
- Follow the manufacturer's dilution recommendations for appropriate contact time and rinse requirements. Follow the chemical manufacturer's guidelines to disinfect.

# Wireless notifications

For product equipped with wireless communication technology, these statements apply to the countries as indicated:

Country	Notification			
Canada	<p>Contains IC: 5123A-BGTWT321</p> <p>This device complies with Innovation, Science and Economic Development Canada's license-exempt RSSs. Operation is subject to the following two conditions: (1) this device may not cause interference, and (2) this device must accept any interference, including interference that may cause undesired operation of the device.</p> <p>Le présent appareil est conforme aux CNR d'Industrie Canada applicables aux appareils radio exempts de licence. L'exploitation est autorisée aux deux conditions suivantes : (1) l'appareil ne doit pas produire de brouillage, et (2) l'utilisateur de l'appareil doit accepter tout brouillage radioélectrique subi, même si le brouillage est susceptible d'en compromettre le fonctionnement.</p>			
Mexico	<p>La operación de este equipo está sujeta a las siguientes dos condiciones: (1) es posible que este equipo o dispositivo no cause interferencia perjudicial y (2) este equipo o dispositivo debe aceptar cualquier interferencia, incluyendo la que pueda causar su operación no deseada.</p>			
Oman	<table border="1" data-bbox="344 772 568 951"> <tr> <td data-bbox="344 772 568 825">Oman – TRA</td> </tr> <tr> <td data-bbox="344 825 568 877">D090024</td> </tr> <tr> <td data-bbox="344 877 568 951">TRA/TA-R/ 11190/21</td> </tr> </table>	Oman – TRA	D090024	TRA/TA-R/ 11190/21
Oman – TRA				
D090024				
TRA/TA-R/ 11190/21				
Singapore	<table border="1" data-bbox="344 997 568 1108"> <tr> <td data-bbox="344 997 568 1108">Complies with IMDA standards DA103640</td> </tr> </table>	Complies with IMDA standards DA103640		
Complies with IMDA standards DA103640				
South Africa	 <p>ICASA TA 2021-0324</p>			

Country	Notification
Thailand	<div data-bbox="349 163 836 651" style="border: 1px solid black; padding: 10px;">  <p>เครื่องวิทยุคมนาคมนี้ ได้รับยกเว้น ไม่ต้องได้รับใบอนุญาตให้มี ใช้งานซึ่งเครื่องวิทยุคมนาคมหรือตั้งสถานีวิทยุคมนาคมตามประกาศ กสทช. เรื่อง เครื่องวิทยุคมนาคม และสถานีวิทยุคมนาคมที่ได้รับยกเว้นไม่ต้องได้รับใบอนุญาตวิทยุคมนาคมตามพระราชบัญญัติวิทยุคมนาคม พ.ศ. 2498</p>  <div style="display: flex; align-items: center;"> <div style="margin-right: 10px;"> <p><b>nab.</b>   โทรคมนาคม</p> <p>กำกับดูแลเพื่อประชาชน</p> <p>Call Center 1200 (InSW)</p> </div> </div> </div>
United States	<p>Contains FCC ID: QQQWT32I</p> <p>This device complies with Part 15 of the FCC Rules. Operation is subject to the following two conditions: (1) this device may not cause harmful interference, and (2) this device must accept any interference received, including interference that may cause undesired operation.</p> <p>Changes or modifications not expressly approved by the party responsible for compliance could void the user's authority to operate the equipment.</p>

# EMC information

## WARNING

- Portable RF communications equipment, including peripherals such as antenna cables and external antennas, should be no closer than 12 inches (30 cm) to any part of the **Secure Connect** locator, including cables specified by the manufacturer.
- Avoid stacking or placing equipment adjacent with other equipment to prevent improper operation of the product. If such use is necessary, carefully observe stacked or adjacent equipment to make sure that they operate properly.
- The use of accessories, transducers, and cables, other than those specified or provided by the manufacturer, could result in increased electromagnetic emissions or decreased electromagnetic immunity and result in improper operation.

The 521200380100 **Secure Connect** locator was evaluated using the following cables:

Cable	Length (m)
AC mains input cable	1.2
Nurse call (DB-37)	2.4

### Guidance and manufacturer's declaration - electromagnetic emissions

The 521200380100 **Secure Connect** locator is intended for use in the electromagnetic environment specified below. The customer or the user of the 521200380100 **Secure Connect** locator should assure that it is used in such an environment.

Emissions test	Compliance	Electromagnetic environment
RF Emissions CISPR 11	Group 1	<b>Note</b> - The emissions characteristics of this equipment make it suitable for use in industrial areas and hospitals (CISPR 11 class A). If it is used in a residential environment (for which CISPR 11 class B is normally required) this equipment might not offer adequate protection to radio-frequency communication services. The user might need to take mitigation measures, such as relocating or re-orienting the equipment.
RF Emissions CISPR 11	Class A	
Harmonic Emissions IEC 61000-3-2	Class A	
Voltage Fluctuations Flicker Emissions IEC 61000-3-3	Complies	

### Guidance and manufacturer's declaration - electromagnetic immunity

The 521200380100 **Secure Connect** locator is suitable for use in a professional healthcare facility environment and not in environments exceeding immunity test conditions that the product was evaluated to, such as near high frequency (HF) surgical equipment and inside of the radio frequency (RF) shielded room of magnetic resonance imaging (MRI) equipment. The customer or the user of the 521200380100 **Secure Connect** locator should assure that it is used in such an environment and that the electromagnetic environment guidance listed below is followed.

Immunity test	IEC 60601 test level	Compliance level	Electromagnetic environment-guidance
Electrostatic Discharge (ESD) IEC 61000-4-2	±8 kV contact ±15 kV air	±8 kV contact ±15 kV air	Floors should be wood, concrete, or ceramic tile. If floors are covered with synthetic material, the relative humidity should be at least 30%.
Electrostatic fast transient/burst IEC 61000-4-4	±2 kV for power supply lines ±1 kV for input/output lines	±2 kV for power supply lines ±1 kV for input/output lines	Main power quality should be that of a typical commercial or hospital environment.

**Guidance and manufacturer's declaration - electromagnetic immunity**

Surge IEC 61000-4-5	±0.5 kV, ±1 kV lines to lines ±0.5 kV, ±1 kV, ±2 kV lines to earth	±0.5 kV, ±1 kV lines to lines ±0.5 kV, ±1 kV, ±2 kV lines to earth	Main power quality should be that of a typical commercial or hospital environment.
Voltage dips, voltage variations and short interruptions on power supply input lines IEC 61000-4-11	0%U <sub>T</sub> for 0.5 cycle at 0°, 45°, 90°, 135°, 180°, 225°, 270°, and 315°  0%U <sub>T</sub> for 1 cycle  70%U <sub>T</sub> (30% dip in U <sub>T</sub> ) for 25/30 cycles  0% U <sub>T</sub> for 250/300 cycles	0%U <sub>T</sub> for 0.5 cycle at 0°, 45°, 90°, 135°, 180°, 225°, 270°, and 315°  0%U <sub>T</sub> for 1 cycle  70%U <sub>T</sub> (30% dip in U <sub>T</sub> ) for 25/30 cycles  0% U <sub>T</sub> for 250/300 cycles	Main power quality should be that of a typical commercial or hospital environment. If the user of the 521200380100 <b>Secure Connect</b> locator requires continued operation during power main interruptions, it is recommended that the device be powered from an uninterrupted power supply or a battery.
Power frequency (50/60 Hz) magnetic field IEC 61000-4-8	30 A/m	30 A/m	Power frequency magnetic fields should be at levels characteristic of a typical location in a typical commercial or hospital environment.

**Note** - U<sub>T</sub> is the a.c. mains voltage before applications of the test level.



<p>Conducted RF IEC 61000- 4-6</p> <p>Radiated RF IEC 61000-4-3</p>	<p>3 Vrms 150 kHz to 80 MHz 3 V/m 80 MHz to 2.7 GHz</p>	<p>3 Vrms 3 V/m</p>	<p>Portable and mobile RF communications equipment should follow the guidance in the table titled “Recommended separation distances between portable and mobile RF communication equipment and the 521200380100 <b>Secure Connect</b> locator.” If the mobile service is not listed in the table, the recommended separation distance should be calculated from the equation appropriate for the frequency of the transmitter.</p> <p>Recommended separation distance  <math>D=(2) (\sqrt{P})</math>  where <math>P</math> is the maximum output power rating of the transmitter in watts (W) according to the transmitter manufacturer and <math>d</math> is the recommended separation distance in meters (m).</p> <p>Field strengths from fixed RF transmitters, as determined by an electromagnetic site survey<sup>a</sup>, should be less than the compliance level in each frequency range<sup>b</sup>.</p> <p>Interference may occur in the vicinity of equipment marked with the following symbol: </p>
---	---	-------------------------	---

**Note** - These guidelines may not apply in all situations. Electromagnetic propagation is affected by absorption and reflection from structures, objects and people.

**Note** - The ISM (Industrial, Scientific, and Medical) bands between 0.15 MHz and 80 MHz are 6.765 MHz to 6.795 MHz; 13.553 MHz to 13.567 MHz; 26.957 MHz to 27.283 MHz; and 40.66 MHz to 40.70 MHz.

<sup>a</sup>Field strengths from fixed transmitters, such as base stations for radio (cellular/cordless) telephones and land mobile radios, amateur radio, AM and FM radio broadcast, and TV broadcast cannot be predicted theoretically with accuracy. To assess the electromagnetic environment due to fixed RF transmitters, an electromagnetic site survey should be considered. If the measured field strength in the location in which the 521200380100 **Secure Connect** locator is used exceeds the applicable RF compliance level above, the 521200380100 **Secure Connect** locator should be observed to verify normal operation. If abnormal performance is observed, additional measures may be necessary, such as reorienting or relocating the 521200380100 **Secure Connect** locator.

<sup>b</sup>Over the frequency range 150 kHz to 80 MHz, field strengths are less than 3 Vrms.

**Recommended separation distances between portable and mobile RF communication equipment and the 521200380100 Secure Connect locator**

The 521200380100 **Secure Connect** locator is intended for use in an electromagnetic environment in which radiated RF disturbances are controlled. The customer or the user of the 521200380100 **Secure Connect** locator can help prevent electromagnetic interferences by maintaining a minimum distance between portable and mobile RF communications equipment (transmitters) and the 521200380100 **Secure Connect** locator, including cables, as recommended below, according to the maximum output power of the communications equipment.

<b>Band (MHz)</b>	<b>Service</b>	<b>Maximum power (W)</b>	<b>Minimum separation distance (m)</b>
380-390	TETRA 400	1.8	0.3
430-470	GMRS 460; FRS 460	2.0	0.3
704-787	LTE Band 13, 17	0.2	0.3
800-960	GSM 800/900; TETRA 800; iDEN 820; CDMA 850; LTE Band 5	2.0	0.3
1,700-1,990	GSM 1800; CDMA 1900; GSM 1900; DECT; LTE Band 1, 3, 4, 25; UMTS	2.0	0.3
2,400-2,570	Bluetooth; WLAN; 802.11 b/g/n; RFID 2450; LTE Band 7	2.0	0.3
5,100-5,800	WLAN 802.11 a/n	0.2	0.3

For transmitters rated at a maximum output power not listed above, the recommended separation distance  $d$  in meters (m) can be estimated using the equation applicable to the frequency of the transmitter, where  $P$  is the maximum output power rating of the transmitter in watts (W) according to the transmitter manufacturer.

**Note** - These guidelines may not apply in all situations. Electromagnetic propagation is affected by absorption and reflection from structures, objects and people.



# stryker



Stryker Medical  
3800 E. Centre Avenue  
Portage, MI 49002  
USA