



**STRYKER GLIDE™**  
Lateral Patient Transfer System  
Model 3061

# stryker®

## Operations/Maintenance Manual



For Parts or Technical Assistance:  
USA: 1-800-327-0770 (option 2)  
Canada: 1-888-233-6888



# Table of Contents

---

Introduction . . . . .	4
Intended Use . . . . .	4
Product Description . . . . .	4
Product Illustration . . . . .	4
Specifications . . . . .	5
Warning / Caution / Note Definition . . . . .	6
Symbols . . . . .	7
Requirements By Symbol For Patient Transfer and Mattress Inflation . . . . .	7
Summary of Safety Precautions . . . . .	8
Operation Guide . . . . .	10
Selecting Appropriate Mattress Size . . . . .	10
Positioning Mattress Underneath The Patient . . . . .	10
Connecting The Air Supply . . . . .	11
Transfer Of Patient From Stretcher To Bed . . . . .	12
Preventative Maintenance . . . . .	13
Maintenance Checklist . . . . .	13
Cleaning . . . . .	14
Routine Care: Mattress . . . . .	14
Routine Care: Protective Sheet . . . . .	14
Routine Care: Blower Unit . . . . .	15
Disinfection . . . . .	15
Blood Contamination . . . . .	15
Troubleshooting Guide . . . . .	16
Service Information . . . . .	17
Hose Replacement . . . . .	17
Power Cord Replacement . . . . .	17
ON/OFF Switch Replacement . . . . .	17
Upper Housing Replacement . . . . .	18
Blower Assembly Replacement . . . . .	18
Quick Reference Replacement Parts List . . . . .	19
3060-000-028 Replacement Part List (Regular) . . . . .	19
3060-000-032 Replacement Part List (Large) . . . . .	19
3060-000-046 Replacement Part List (Bariatric) . . . . .	19
Blower Unit Assembly, Standard - 3060-400-110 . . . . .	20
Blower Base with Feet - 3060-001-125 . . . . .	22
Hose Assembly, Standard - 3060-001-127 . . . . .	23
Hose Assembly, Optional 25'- 3060-045-002 . . . . .	24
Mattress Assemblies . . . . .	25
Tote Assembly - 3060-001-041 . . . . .	26
Warranty . . . . .	27
Limited Warranty . . . . .	27
To Obtain Parts and Service . . . . .	27
Return Authorization . . . . .	27
Damaged Merchandise . . . . .	27
EMC Information . . . . .	28

# Introduction

---

## INTENDED USE

This manual is designed to assist you with the safe operation and maintenance of the GLIDE™. Carefully read this manual thoroughly before using the equipment or beginning maintenance on it. To ensure safe operation of this equipment, it is recommended that methods and procedures be established for educating and training staff on the safe operation of this GLIDE™.

## PRODUCT DESCRIPTION

The GLIDE™ includes one model for use in the United States and Canada. The GLIDE™ transfers a patient on a soft nylon mattress designed with hundreds of tiny perforations on the underside. The air supply attaches to the mattress and pumps air out through the tiny perforations on the underside of the mattress. The continuous air flow helps to reduce friction between the sleep surface and the GLIDE™ Matt allowing the operator to transfer the patient with ease.

## PRODUCT ILLUSTRATION

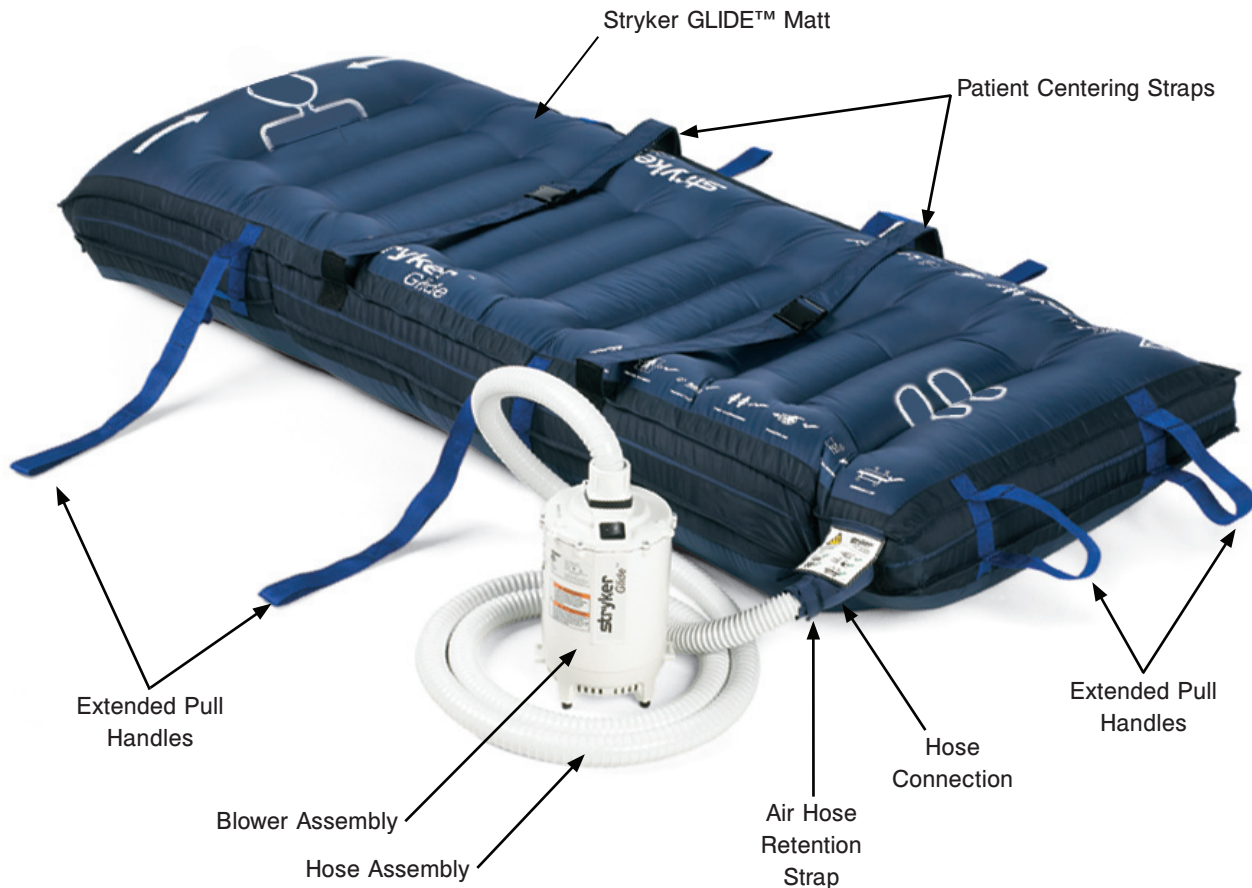

# Introduction

## SPECIFICATIONS

<b>Mattress</b>			
<b>3061-110-028</b>			
• Regular (width x length)	28" x 78"	71,1 cm x 198,1 cm	
• Weight (including protective cover)	3.5 lbs.	1.6 kg	
• Patient Capacity Limit			
• Weight Limit	500 lbs.	226.8 kg	
• Width Limit	28"	71 cm	
• Nylon, Polyurethane under coated, water resistant, anti-static, non-latex			
<b>3061-110-032</b>			
• Large (width x length)	32" x 78"	81,3 cm x 198,1 cm	
• Weight (including protective cover)	5 lbs.	2.3 kg	
• Patient Capacity Limit			
• Weight Limit	700 lbs.	317.5 kg	
• Width Limit	32"	81,3 cm	
• Nylon, Polyurethane under coated, water resistant, anti-static, non-latex			
<b>3061-110-046</b>			
• Bariatric (width x length)	46" x 80"	116,8 cm x 198,1 cm	
• Weight (including protective cover)	6.5 lbs.	2.9 kg	
• Patient Capacity Limit			
• Weight Limit	1000 lbs.	453.6 kg	
• Width Limit	46"	116,8 cm	
• Nylon, Polyurethane under coated, water resistant, anti-static, non-latex			
<b>Protective Sheet</b>			
3061-120-028	34" x 79"	86,4 cm x 200,1 cm	
3061-120-032	36" x 79"	91,4 cm x 200,1 cm	
3061-120-046	54" x 82"	137,2 cm x 208,3 cm	
<b>Air Supply / Power Requirements</b>			
Domestic 3060-001-210 (US / CAN)	Electrical	120 VAC, 50/60 Hz, 12Amps Power Cord - ST 2-16 Type w/NEMA 115P Polarized Plug	
	Weight	8.5 lbs.	3.9 kg
<b>Duty Cycle</b>	30 seconds ON / 1 minute OFF for 5 cycles followed by a 30 minute rest period.		
<b>Product Compliance</b>	IEC/EN 60601-1		
	UL 60601-1		
	CAN/CSA-C22.2 No 601.1-M90		
	IEC/EN 60601-1-2:2001		

[Return To Table of Contents](#)

# Introduction

## SPECIFICATIONS (CONTINUED)

Environmental Conditions	Operation	Storage and Transportation
Ambient Temperature		
Relative Humidity (Non-Condensing)		
Atmospheric Pressure		

**Stryker reserves the right to change specifications without notice.**

Specifications listed are approximate and may vary slightly from unit to unit or by power supply fluctuations.

### WARNING / CAUTION / NOTE DEFINITION

The words WARNING, CAUTION, and NOTE carry special meanings and should be carefully reviewed.

#### WARNING

Alerts the reader about a situation, which if not avoided, could result in death or serious injury. It may also describe potential serious adverse reactions and safety hazards.









#### CAUTION



Alerts the reader of a potentially hazardous situation, which if not avoided, may result in minor or moderate injury to the user or patient or damage to the equipment or other property. This includes special care necessary for the safe and effective use of the device and the care necessary to avoid damage to a device that may occur as a result of use or misuse.

#### Note

This provides special information to make maintenance easier or important instructions clearer.

# Symbols

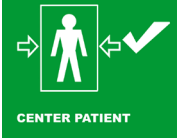
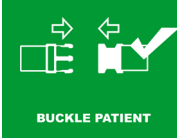
	Warning / Caution - Consult accompanying documentation
	Maximum Safe Working Load
	Maximum Patient Width
~	Alternating Current
	Class II Equipment: Equipment in which protection against electric shock does not rely on basic insulation only, but in which additional safety precautions such as double insulation or reinforced insulation are provided, there being no provision for protective earthing or reliance upon installation conditions.
	Type B Equipment: equipment providing a particular degree of protection against electric shock, particularly regarding allowable leakage current and reliability of the protective earth connection.
	Indicates Power Off position on black power rocker switch
	Indicates Power On position on black power rocker switch
<b>IPX0</b>	No protection against harmful ingress of water.
	Medical Equipment Classified by Underwriters Laboratories Inc. with respect to Electric Shock, Fire, Mechanical and Other Specified Hazards Only in Accordance with UL 60601-1, First Edition (2003) and CAN/CSA C22.2 No. 601.1-M90 with updates 1 and 2.

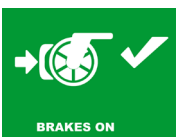
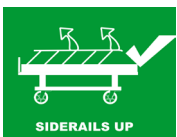
REQUIREMENTS BY SYMBOL FOR PATIENT TRANSFER AND MATTRESS INFLATIONS			
	Patient must be centered on mattress prior to starting inflation process.		Patient must be secured on the mattress prior to starting inflation process.
	Patient Support Platform must be at a position of zero Trendelenburg prior to starting inflation process.		A minimum of two caregivers is required when transferring a patient.
	Patient Support Platform brakes must be set to "ON" prior to starting inflation process.		Patient Support Platform siderails must be in the "UP" position prior to starting inflation process or transferring a patient.

[Return To Table of Contents](#)

# Summary of Safety Precautions

---

## WARNINGS

---

- Never leave patient unattended while the GLIDE™ mattress is inflated and air supply is on.
- The GLIDE™ equipment is not suitable for use in the presence of a flammable anesthetic mixture with air, oxygen or nitrous oxide.
- Mattress must be oriented so that white symbols are pointing upwards.
- The GLIDE™ is not to be used as an air mattress for patient stays with the blower on.
- Do not place and operate the GLIDE™ blower unit in close proximity to uncontrollable fluids or biomass.
- Medical electrical equipment requires special precautions regarding EMC and needs to be installed and put into service according to the EMC information provided on [page 28](#) to prevent equipment malfunction. Portable and mobile RF communication equipment can affect Medical Electrical Equipment.
- The GLIDE™ is not to be used in the presence of flammable anesthetics.
- The GLIDE™ is not to be used in oxygen rich environments or hyperbaric chambers
- The GLIDE™ is not to be used in the presence of open sources of ignition such as cigarettes, etc...
- Patient straps are used to center patient on the product during inflation and deflation. They are not intended to be safety restraint straps that keep the patient on the stretcher or bed.
- The GLIDE™ blower and mattress are not to be used as a patient warmer.
- The GLIDE™ blower is not to be used with other manufacturers air transfer mattresses.
- The GLIDE™ air transfer mattress is not to be used with other manufacturing blowers.
- Patient is to be centered before and during inflation.
- Patient support surface (i.e. stretcher, bed, operating table, etc...) must be at 0° trendelenburg or level to prevent the patient moving under their own weight. The patient support surface should be level with one another.
- When using the GLIDE™ side rails must be raised to act as guards to stop the patients movement during a transfer.
- When using the GLIDE™ for transfers between products that have a transfer gap greater than three inches, the transfer bridge must be used. **The transfer bridge is not meant to support a patient load.** The transfer bridge is meant to ease transfer of a patient from one patient support surface (i.e. stretcher, bed, etc.) to another. Always insure that the patient support surfaces and their respective transfer gaps are adequate to support the patient.
- The GLIDE™ is to be used with a minimum of two care givers. Care givers need to be positioned so that they can control positioning of patient.
- The GLIDE™ must be centered under patient without any bunching present. Bunching will cause patient to be pushed / lifted off center.
- The GLIDE™ can only be used on transfers between fixed patient support surfaces. Mobile surfaces need the brakes applied to make them a fixed surface.
- Stow accessories such as the Stryker pop-up push handles before beginning a transfer using the GLIDE™.



# Summary of Safety Precautions

---

## CAUTIONS

---

- Do not operate air supply motor near equipment that is sensitive to electromagnetic interference.
- There is a weight limit on the mattress, the bed, gurney or other surface that the mattress is being used on. Adhere to all weight limits as stated in accompanying documentation.
- Insert hose into matt and secure with Velcro strap.
- Inspect mattress for seam failures.
- Do not leave the GLIDE™ mattress under patients susceptible to decubitus ulcers.
- Do not leave patients laying on the buckles of the centering straps.
- To avoid malfunction, this product should not be used adjacent to or stacked with other equipment. If stacked use is necessary, this product should be observed to verify normal operation in the configuration in which it will be used.
- The mattress size is specified in two ways; by the weight of the patient and by the physical size of the patient. Selection of an inappropriately sized matt may reduce the overall transfer performance of the Glide or may cause harm to the patient or the caregiver.

### Note

- Maximum leakage current shall not exceed 100 micro amps on air supply enclosure and 100 micro amps on air mattress.
- No automatic pressure relief exists on device.

# Operation Guide

---

Operating the GLIDE™ is a three step process; positioning the mattress under patient, connecting air supply, then transferring patient from stretcher to bed. See detailed instructions below.

## SELECTING APPROPRIATE MATTRESS SIZE

The mattress size is specified in two ways; by the weight of the patient and by the physical size of the patient. Selection of an inappropriately sized mattress may reduce the overall transfer performance of the Glide or may cause harm to the patient or the caregiver.

The selection of the appropriate size mattress is characterized as follows:

- 28" mattress is appropriate for patients up to a weight of 500 lbs. and a maximum width of 28".
- 32" mattress is appropriate for patients up to a weight of 700 lbs. and a maximum width of 32".
- 46" mattress is appropriate for patients up to a weight of 1000 lbs. and a maximum width of 46".

Selection of the appropriate size mattress is determined by comparing the width of the patient to the width of the deflated mattress. The width of the patient shall not exceed the width of the deflated mattress at any point along its length.

## POSITIONING MATTRESS UNDERNEATH THE PATIENT

### Note

- The GLIDE™ is to be used with a minimum of two caregivers. Caregivers need to be positioned so that they can control positioning of the patient.
  - If soiling is possible, place protector sheet on top of mattress, dull side down, before it is positioned underneath the patient.
1. Roll the mattress lengthwise towards center from one side such that the side with the perforations will be against the bed, not the patient.
  2. Place the mattress under the patient using a "log-rolling" technique.  
**Note: Ensure the patient's head is located at the same end as the "HEAD" label on the mattress topside.**
    - a. Roll the patient onto their side toward the attendant, (the bed sheet can be used to help with the log roll).
    - b. Place the rolled edge of the mattress against the patient.
    - c. Roll the patient back towards the opposite side enough to unroll the mattress as you would when changing a bed sheet.
    - d. Center the patient on the mattress.
  3. Attach the two patient centering straps in gentle contact with the patient. Straps need not be tight.  
**Note: Do not pull on the patient centering straps to transfer the patient.**

# Operation Guide

## CONNECTING THE AIR SUPPLY

1. Ensure the ON/OFF (I / O) switch is positioned to “OFF” (O) as shown in Figure 1.1.

**Note:** Not confirming ON/OFF switch is positioned to “OFF” may result in harm to the patient and/or operator of the device.

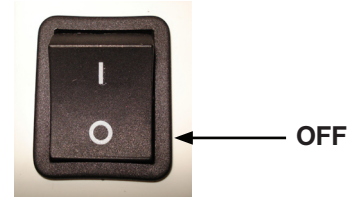

Figure 1.1

2. Plug the power cord of the air supply into the electrical outlet on the wall.
3. Attach one end of the flexible hose with the rubber grommet to the air supply as shown in Figure 1.2.
4. Insert the other end of the flexible hose into the mattress sleeve under the label flap as shown in Figure 1.2.

**Note:** Ensure that the hose cuff is fully inserted into the mattress sleeve as shown in Figure 1.3.

5. Wrap the Velcro strap around the mattress sleeve as shown in Figure 1.4.

**Note:** The Velcro strap must be fastened around the flexible hose, not the hose cuff.



Figure 1.2



Figure 1.3



Figure 1.4

6. Using the air hose retention straps, secure the air hose to the mattress.

**Note:** The air supply unit can remain in the roller bag if needed.

# Operation Guide

---

## TRANSFER OF PATIENT FROM STRETCHER TO BED

1. Position the stretcher alongside the patient's bed as close as possible.
2. Securely engage the brakes on the Mobile Patient Support Platform.
3. Raise the stretcher siderail located opposite the patient transfer.
4. Adjust the bed or stretcher height so that they are as close to the same level as possible.

**Note: If the space between the patient's bed and stretcher is greater than 3", use the transfer bridge to fill the gap.**

5. Before turning air supply unit on, verify the following:
  - a. Siderails, accessories or sharp object are not obstructing the path of the mattress.
  - b. The air hose should be free to travel with the mattress.
  - c. All patient support systems such as I.V. lines or oxygen hoses are free to travel with the patient.
  - d. An attendant is positioned in the direction of the patient transfer.
6. Turn "ON" the air supply by pressing the switch to the "I" position (Figure 2).
7. Wait approximately 10-15 seconds for the mattress to fully inflate.
8. Once mattress is fully inflated, grasp extended pull handles of mattress while keeping your back in the neutral ergonomic upright posture.
9. With one firm continuous pull, move the patient towards the attendant to the desired surface ending with the patient centered on the new surface.
10. Turn "OFF" air supply by pressing the switch to the "O" position (Figure 2).
11. Unplug power cord from wall and air supply.

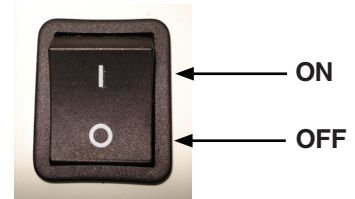

Figure 2

---

 **WARNING**

Never leave patient unattended when mattress is inflated and air supply is on.

---

# Preventative Maintenance

---

## MAINTENANCE CHECKLIST

- \_\_\_\_\_ All fasteners secure (reference all assembly drawings).
- \_\_\_\_\_ Hose assembly is not damaged or leaking.
- \_\_\_\_\_ Power switch is working properly.
- \_\_\_\_\_ Power cord is not frayed and is attached to blower assembly.
- \_\_\_\_\_ Plastic on the blower assembly is not damaged.
- \_\_\_\_\_ Mattress holds air and all straps are intact.
- \_\_\_\_\_ Current leakage not to exceed 100 micro amps.

Unit Serial Number:		

Completed by: \_\_\_\_\_

Date: \_\_\_\_\_

# Cleaning

---

## CAUTION

---

- Do not use harsh cleaners or solvents on mattress fabric.
- Follow all manufacturer directions for dilution of concentrated cleaning agents.
- Machine laundering or drying of mattress fabric is not recommended.
- Do not wash the mattress fabric in hot water.
- Do not iron the mattress fabric.
- Do not use Iodophor type disinfectants on the mattress fabric.
- The materials used to manufacture the mattress fabric and the performance of the fabric may be adversely affected by permitting any cleaning agent to remain in contact with the fabric for a prolonged duration or a failure to adequately rinse the agent from the fabric.
- Do not immerse blower unit in any water or cleaning solutions. **Hand wash the blower unit exterior surface only.** Ensure water or cleaning solutions do not come in contact with any inner components of the blower unit. Dry thoroughly before putting the blower unit back into service.
- Do not PRESSURE WASH, HOSE OFF or ULTRASONICALLY CLEAN the Blower Unit.
- Failure to follow said CAUTIONS may result in damage to the mattress, protective sheet or blower unit.

### ROUTINE CARE: Mattress

- Wipe fabric clean with lukewarm water and a mild cleaning agent.  
Suggested cleaning agent:
  - 10% bleach and water or;
  - Any properly diluted EPA approved phenolic or quaternary cleaning solution.
- The cleaning solution should be sprayed on or applied with paper towels or disposable cleaning cloths using hospital protocol for bed mattresses.
- The mattress and sheet should be wiped down with the suggested cleaning agent in between patient use.
- Hard to Clean Areas: Soft sponge with liquid cleaner as specified on manufacturer's product label.
- To control or prevent odors on long term incontinent applications, clean mattress daily. The use of a scented cleaner/disinfectant is recommended.
- Rinse thoroughly and allow drying before returning to service.

### ROUTINE CARE: Protective Sheet

- Wipe fabric clean with lukewarm water and a mild cleaning agent.  
Suggested cleaning agent:
  - 10% bleach and water or;
  - Any properly diluted EPA approved phenolic or quaternary cleaning solution.
- The cleaning solution should be sprayed on or applied with paper towels or disposable cleaning cloths using hospital protocol for bed mattresses.
- The mattress and sheet should be wiped down with the suggested cleaning agent in between patient use.
- Hard to Clean Areas: Soft sponge with liquid cleaner as specified on manufacturer's product label.
- To control or prevent odors on long term incontinent applications, clean mattress daily. The use of a scented cleaner/disinfectant is recommended.
- Rinse thoroughly and allow drying before returning to service.
- For heavily soiled Protective Sheets, machine laundering can be performed. Recommended cleaners include neutral detergent or 10% bleach and water solution. Water temperature should not exceed 150 degrees Fahrenheit.
- The Protective Sheet should be air dried if possible. Machine drying can be performed as long as the maximum air or drum temperature does not exceed 120 degrees Fahrenheit.

# Cleaning

---

## ROUTINE CARE: Blower Unit

---

### CAUTION

Do not immerse blower unit in any water or cleaning solutions. **Hand wash the blower unit exterior surface only.** Ensure water or cleaning solutions do not come in contact with any inner components of the blower unit. Dry thoroughly before putting the blower unit back into service.

- Hand wash all surfaces of the blower unit with lukewarm water and a mild cleaning agent.  
Suggested cleaning agent:
  - 10% bleach and water or;
  - Any properly diluted EPA approved phenolic or quaternary cleaning solution.
- When a mild cleaning agent is not adequate, follow the instructions provided by the cleaning product manufacturer for ammonia, bleach, isopropyl alcohol, and ammonium chloride based cleaning solutions. Dampen a soft cloth with the diluted cleaner and wipe all surfaces of the blower unit.
- Dry thoroughly by wiping all surfaces with a dry cloth to remove any moisture.

### DISINFECTION

- Most phenolic or quaternary type disinfectants can be used on the mattress fabric. User must dilute disinfectants and germicides in accordance with manufacturer's instructions.
- Iodophor type disinfectants (Betadine, for example) will stain the mattress fabric.

### BLOOD CONTAMINATION

- The mattress fabric can be disinfected with a 1:10 dilution of household bleach (5.25% sodium hypochlorite) as recommended by the CDC (US Department of Health and Human Services, February 1989). Weaker dilutions, e.g. 1:100 may be used but may not be in accordance with CDC recommendations.

**Note:** Always wash hands thoroughly after cleaning the mattress, protective sheet or blower unit.

# Troubleshooting Guide

Problem / Failure	Recommended Action
No Power to the Blower.	<ol style="list-style-type: none"> <li>1. Verify the switch is in the ON (I) position.</li> <li>2. Check the power outlet by trying another outlet.</li> <li>3. Check the power cord for 120VAC.               <p><b>NOTE: The power cord plugs into the OFF (0) side of the switch.</b></p> <ol style="list-style-type: none"> <li>a. Access the power cord connections by referencing <a href="#">page 17</a>, “Power Cord Replacement”, using a voltmeter between the power cord wires there should be 120VAC with the power cord plugged into the wall.                   <ol style="list-style-type: none"> <li>i. If you do not have 120VAC, replace the power cord assembly.</li> <li>ii. If you do have 120VAC, go to step b.</li> </ol> </li> <li>b. Check for continuity between the outlet end of the power cord and the switch end of the power cord for both wires.                   <ol style="list-style-type: none"> <li>i. If you do not have continuity on one of the wires, replace the power cord assembly.</li> <li>ii. If you do have continuity, go to step 4.</li> </ol> </li> </ol> </li> <li>4. Check the power switch for continuity.               <p><b>NOTE: The blower plugs into the ON (I) side of the switch.</b></p> <ol style="list-style-type: none"> <li>a. Unplug the blower unit from the switch, using a voltmeter on one side of the switch going between the ON and the OFF check for continuity by moving the switch from ON to OFF.                   <ol style="list-style-type: none"> <li>i. If this was done on both sides and one or both sides with no continuity, replace the power switch.</li> <li>ii. If you do have continuity, replace the blower assembly.</li> </ol> </li> </ol> </li> </ol>
Mattress will not inflate properly.	<ol style="list-style-type: none"> <li>1. Check the air hose assembly and the mattress assembly for any visual or audio air leaks and repair.</li> <li>2. Check for blockage in the air hose assembly and repair.</li> <li>3. Check for a strong volume of air from the blower assembly.               <ol style="list-style-type: none"> <li>a. Turn the blower on with the air hose assembly removed.                   <ol style="list-style-type: none"> <li>i. If the air volume diminished, check the air inlet on the lower housing for restrictions and repair.</li> <li>ii. If there was no restriction in the lower housing, replace the blower assembly.</li> </ol> </li> </ol> </li> </ol>



# Service Information

---

## HOSE REPLACEMENT

### No Tools Required

#### Procedure:

1. Grab base of hose and turn counter-clockwise then remove.
2. Take the new hose and properly key the base of the hose to the upper housing of blower unit assembly then turn clockwise.

## POWER CORD REPLACEMENT

### Tools Required:

- T-20 Torx Driver
- Phillips Head Screwdriver

#### Procedure: Note - Reference Blower Unit Assembly [page 20](#) when performing these procedures.

1. Unplug unit from the wall if it is plugged in.
2. Remove Hose Assembly.
3. Using a T-20 Torx driver, remove the two T-20 Torx screws that fasten the strain relief retainer to the upper housing.
4. Using a Phillips head screwdriver, remove the six Phillips head screws that fasten the upper housing to the main housing then remove the upper housing.
5. Disconnect the black and white wire connectors from the switch assembly.
6. Remove the power cord by pulling the black and white wires back up through the upper housing.
7. Install the new power cord.
8. Repeat the above steps in reverse order to reassemble.

**Note: Power cord connections are on the OFF (O) side of the switch.**

**Note: Do not overtighten the screws.**

## ON/OFF SWITCH REPLACEMENT

### Tools Required:

- Phillips Head Screwdriver

#### Procedure:

1. Unplug unit from the wall if it is plugged in.
2. Remove Hose Assembly.
3. Using a Phillips head screwdriver, remove the six Phillips head screws that fasten the upper housing to the main housing then remove the upper housing.
4. Disconnect the power cord and the blower assembly connections from the switch assembly.
5. Remove the switch by pressing from the bottom and pull through the top of the upper housing.
6. Install the new switch assembly.
7. Repeat the above steps in reverse order to reassemble.

**Note: Power cord connections are on the OFF (O) side of the switch. Blower assembly connections are on the ON (1) side of the switch.**

**Note: Do not overtighten the screws.**

# Service Information

---

## UPPER HOUSING REPLACEMENT

### Tools Required:

- T-20 Torx Driver
- Phillips Head Screwdriver
- Wire Cutters

### Procedure:

1. Unplug unit from the wall if it is plugged in.
2. Remove Hose Assembly.
3. Using a Phillips head screwdriver, remove the six Phillips head screws that fasten the upper housing to the main
4. housing and separate.
5. Remove the power cord (reference the Power Cord Replacement procedures on [page 17](#)).
6. Remove the ON/OFF switch (reference the ON/OFF Switch Replacement procedures on [page 17](#)).
7. Using wire cutters, cut the plastic cable tie that connects the blower assembly wire harness to the upper housing.
8. Remove the old upper housing assembly and install the new upper housing assembly.
9. Repeat the above steps in reverse order to reassemble.

**NOTE: Do not overtighten the screws.**

## BLOWER ASSEMBLY REPLACEMENT

### Tools Required:

- Phillips Head Screwdriver
- Diagonal Pliers

### Procedure:

1. Unplug unit from the wall if it is plugged in.
2. Remove Hose Assembly.
3. Using a Phillips head screwdriver, remove the six Phillips head screws that fasten the upper housing to the main housing then remove the upper housing.
4. Using wire cutters, cut the plastic cable that connects the blower assembly wire harness to the upper housing.
5. Disconnect the two blower assembly connectors from the switch assembly.
6. Using a Phillips head screwdriver, remove the six Phillips head screws that fasten the blower assembly to the bottom of the main housing.
7. Remove the blower assembly by grasping the blower assembly wire harness and lifting straight up and out of the main housing assembly.
8. Install the new blower assembly.
9. Install new wire tie.
10. Repeat the above steps in reverse order to reassemble.

**NOTE: Do not overtighten the screws.**

# Quick Reference Replacement Parts List

## Note

The parts and accessories listed on this page are all currently available for purchase. Please call Stryker Customer Service (800)-327-0770 (Option 2).

3060-000-028 REPLACEMENT PART LIST (REGULAR)	
Part Name	Part Number
Air Mattress Assembly (includes Protective Sheet)	3061-500-028
Protective Sheet	3061-120-028
Transfer Bridge	3060-001-146
Blower Unit	3060-400-110
Power Cord	3060-001-802
Air Hose - 8'	3060-001-127
Tote Assembly for GLIDE™	3060-001-041
Hook Assembly	3060-001-130

3060-000-032 REPLACEMENT PART LIST (LARGE)	
Part Name	Part Number
Air Mattress Assembly (includes Protective Sheet)	3061-500-032
Protective Sheet	3061-120-032
Transfer Bridge	3060-001-146
Blower Unit	3060-400-110
Power Cord	3060-001-802
Air Hose - 8'	3060-001-127
Tote Assembly for GLIDE™	3060-001-041
Hook Assembly	3060-001-130

3060-000-046 REPLACEMENT PART LIST (BARIATRIC)	
Part Name	Part Number
Air Mattress Assembly (includes Protective Sheet)	3061-500-046
Protective Sheet	3061-120-046
Transfer Bridge	3060-001-146
Blower Unit	3060-400-110
Power Cord	3060-001-802
Air Hose - 8'	3060-001-127
Tote Assembly for GLIDE™	3060-001-041
Hook Assembly	3060-001-130

[Return To Table of Contents](#)

# Blower Unit Assembly, Standard - 3060-400-110

Assembly Part Number: 3060-001-210 (reference only)

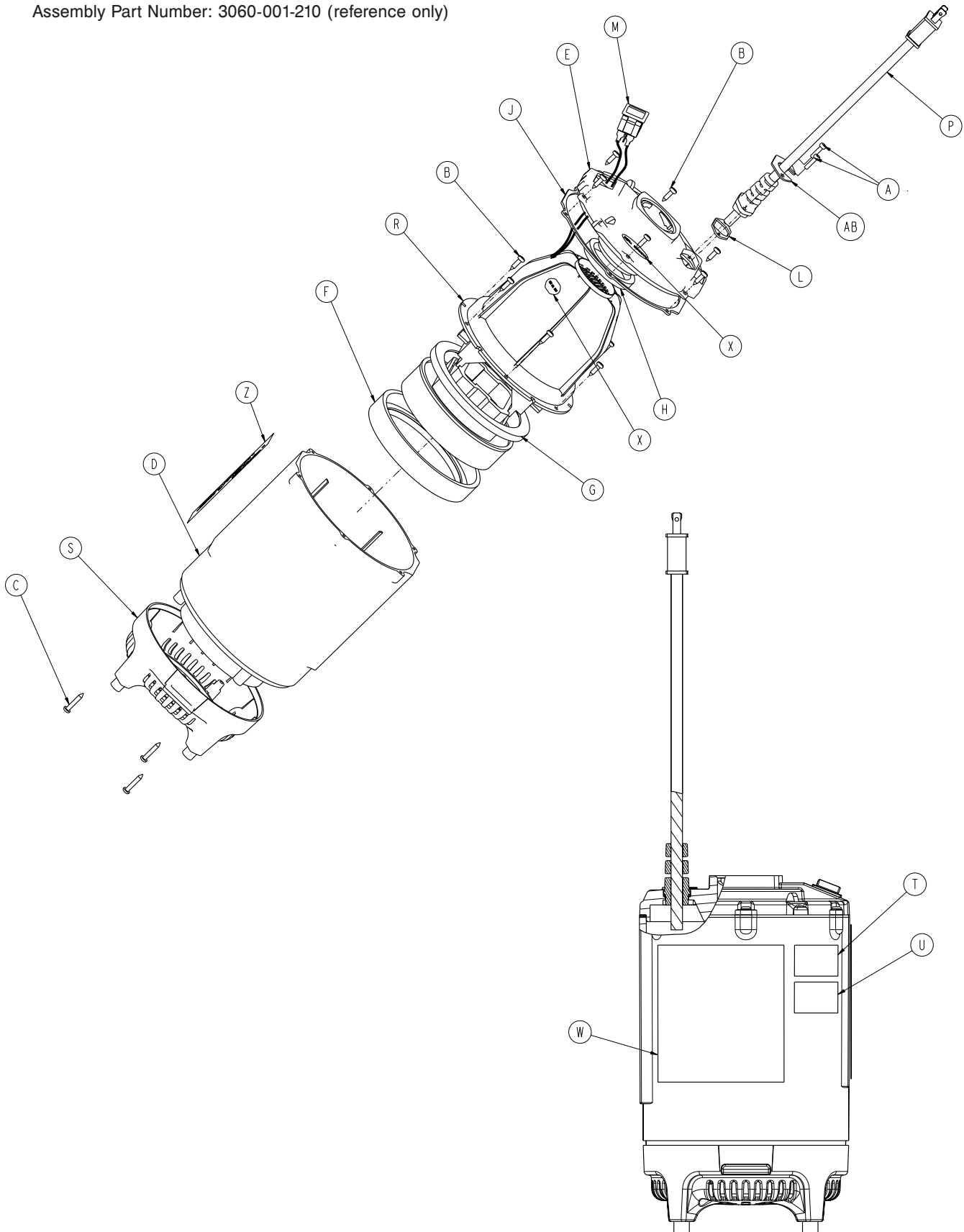

# Blower Unit Assembly, Standard - 3060-400-110

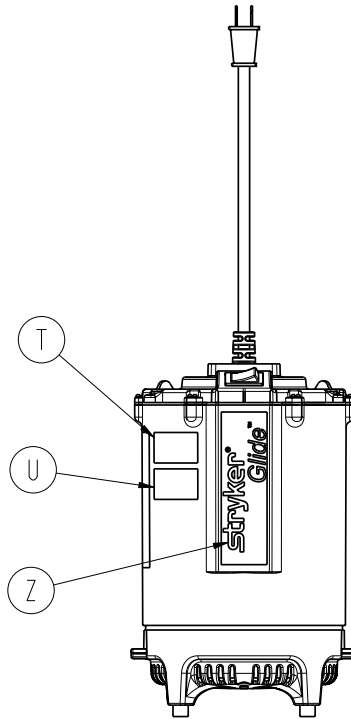

## Blower Unit Assembly Components - 3060-001-210 (reference only)

Item	Part No.	Part Name	Qty.
A	0023-119-000	Screw	2
B	0023-120-000	Phillips Head Truss Screw	12
C	0023-121-000	Phillips Head Truss Screw	3
D	3060-001-112	Housing	1
E	3060-001-113	Housing, Upper	1
F	3060-001-116	Gasket, Blower Bottom	1
G	3060-001-118	Gasket, Blower Top	1
H	3060-001-119	Gasket Blower Housing	1
J	3060-001-123	Gasket, Top Cover	1
L	3060-001-144	Gasket	1
M	3060-001-161	Switch	1
P	3060-001-802	Power Cord Assembly	1
R	3060-001-804	Blower Assembly	1
S	3060-001-125	Blower Base with Feet	1
T	3060-009-139	Spec Label	1
U	3060-009-153	Caution Label	1
W	3060-009-158	Instruction Label	1
X	3060-009-159	Serial Number Label	2
Z	3060-009-161	Stryker Glide™ Blower Label	1
AB	3060-001-169	Strain Relief Retainer	1

# Blower Base with Feet - 3060-001-125

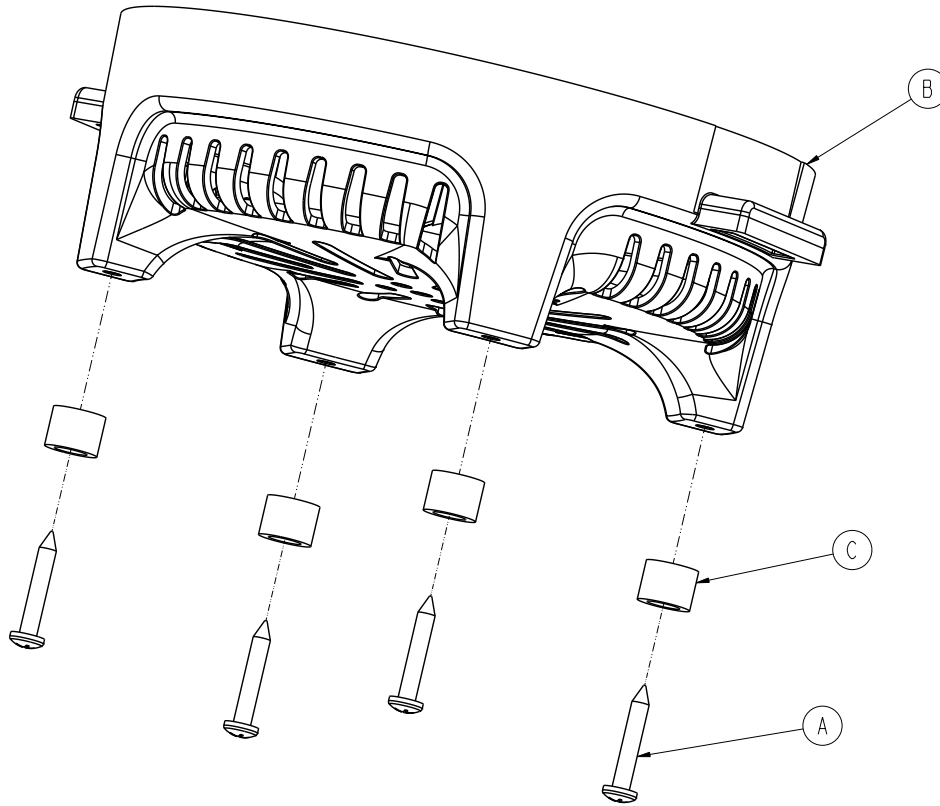

Item	Part No.	Part Name	Qty.
A	0023-190-000	Phillips Head Truss Screw	4
B	3060-001-124	Blower Base	1
C	3060-008-003	Blower Base Bumper	4

# Hose Assembly, Standard - 3060-001-127

---

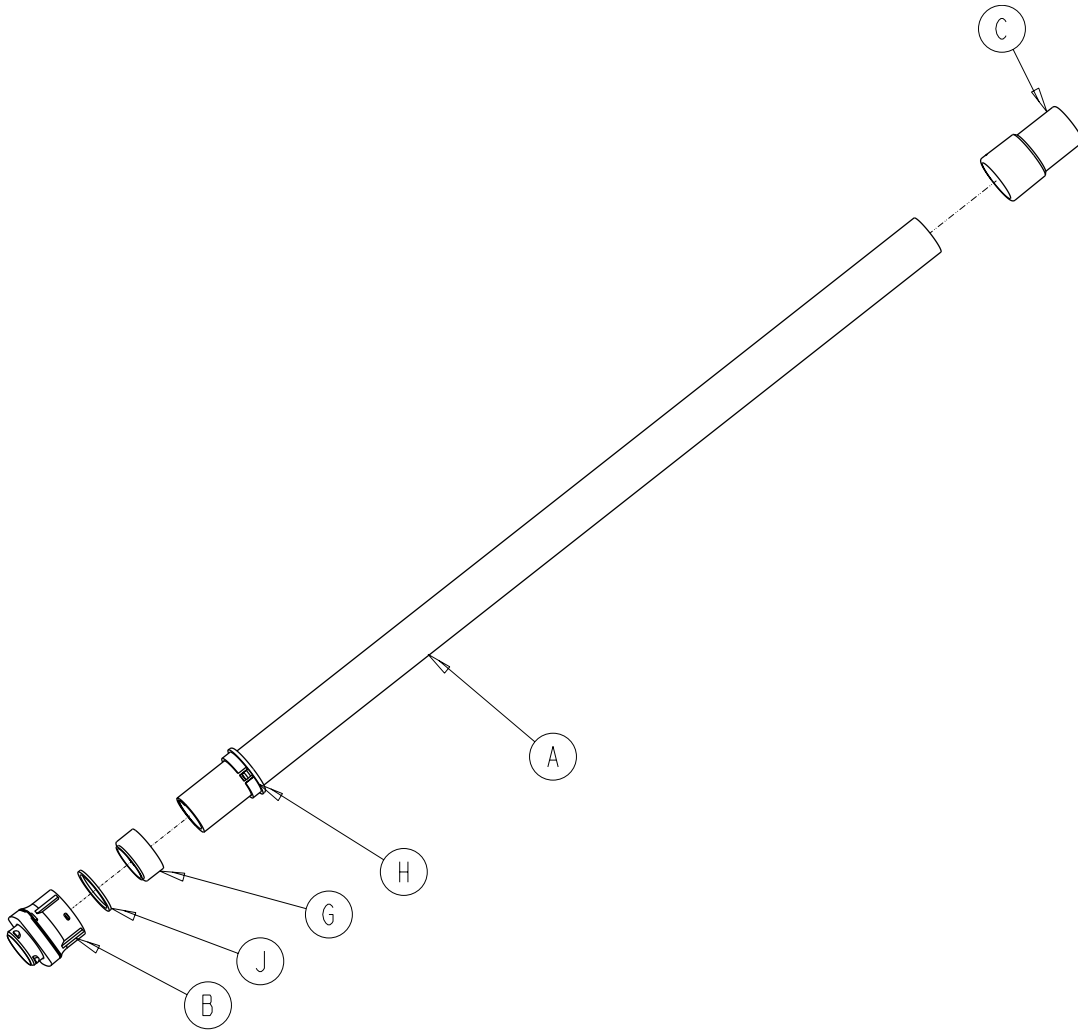

**NOTE: PARTS NOT SOLD SEPARATELY.**

Item	Part No.	Part Name	Qty.
A	3060-001-128	Hose, Standard	1
B	3060-001-129	Hose End Assembly	1
C	3060-001-137	Hose/Mattress Coupling	1
G	3060-001-131	Hose Coupling, Matt	1
H	3060-001-132	Hose Retainer Bracket	1
J	3060-001-133	Hose Gasket	1

[Return To Table of Contents](#)

# Hose Assembly, Optional 25'- 3060-045-002

---

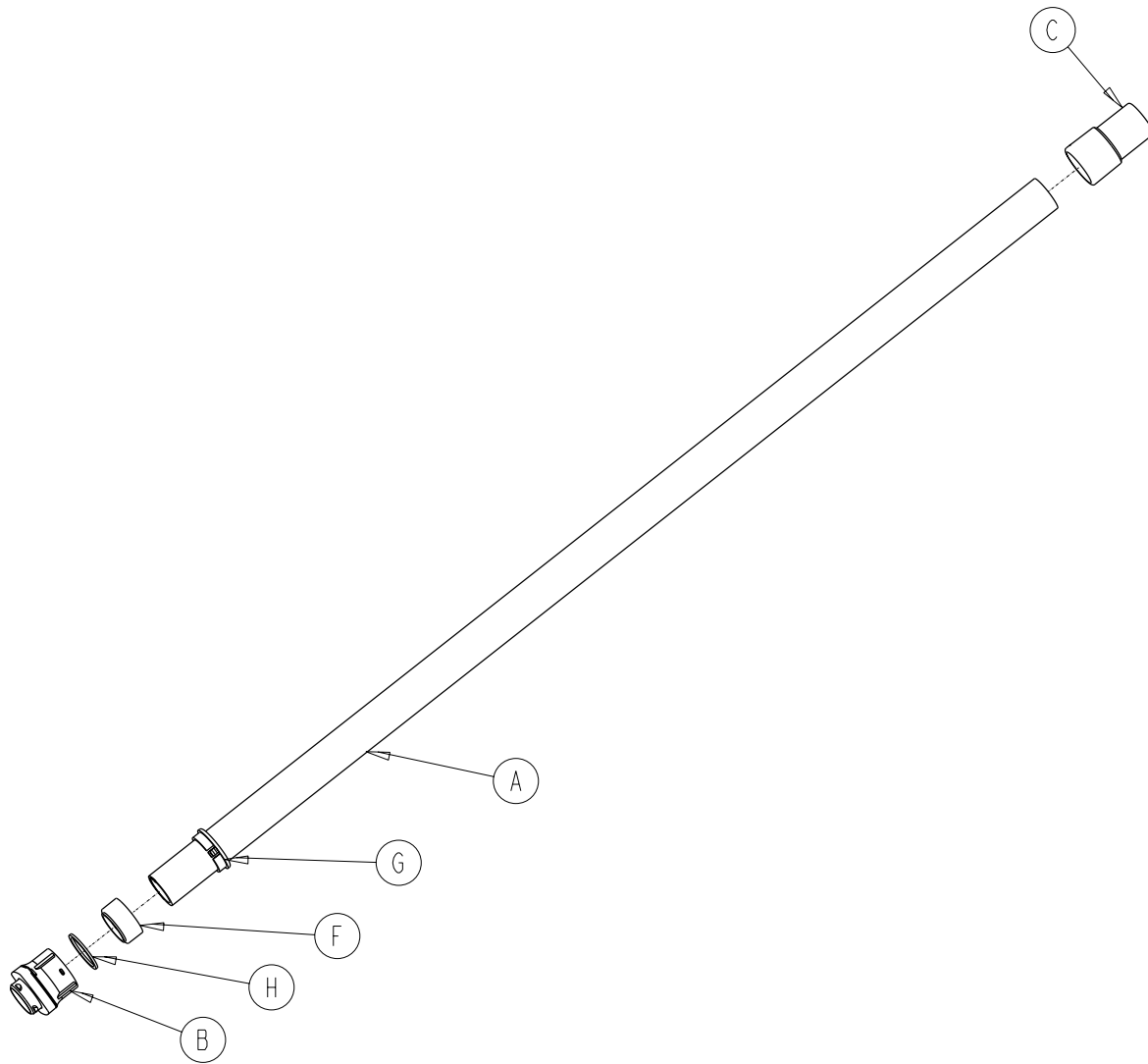

**NOTE: PARTS NOT SOLD SEPARATELY.**

Item	Part No.	Part Name	Qty.
A	3060-045-003	Hose, 25'	1
B	3060-001-129	Hose End Assembly	1
C	3060-001-137	Hose/Mattress Coupling	1
G	3060-001-131	Hose Coupling, Matt	1
H	3060-001-132	Hose Retainer Bracket	1
J	3060-001-133	Hose Gasket	1



# Mattress Assemblies

28" Regular - 3061-110-028 (reference only)

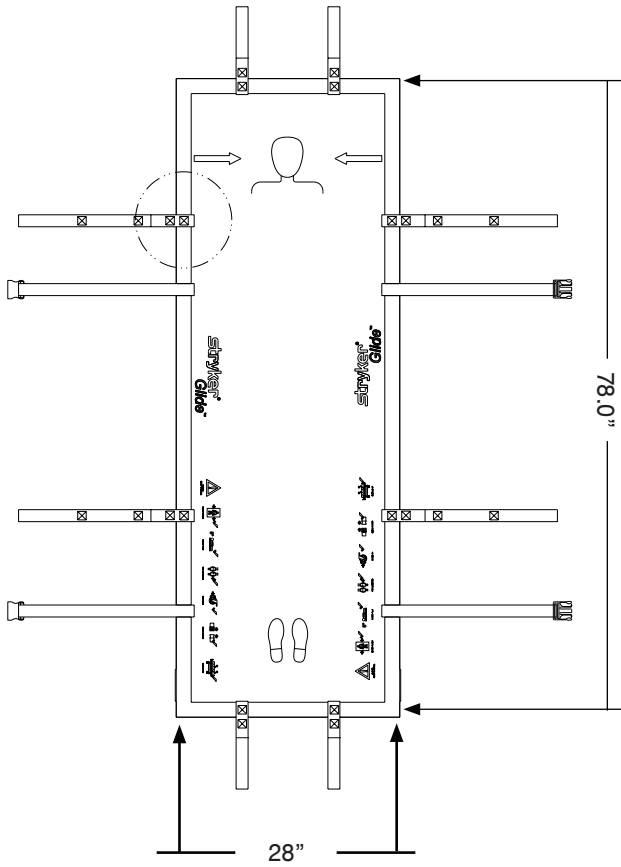

32" Large - 3061-110-032 (reference only)

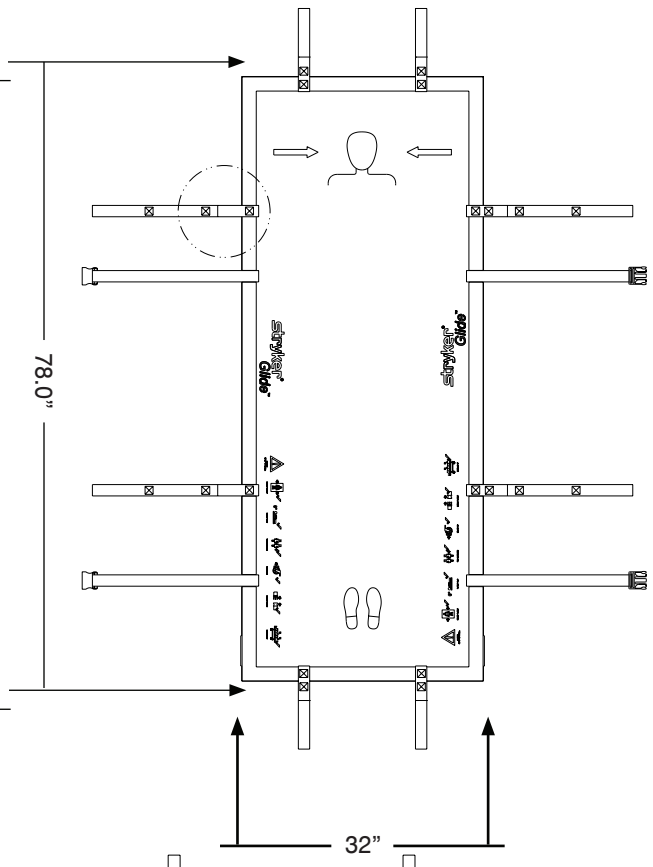

46" Bariatric - 3061-110-046 (reference only)

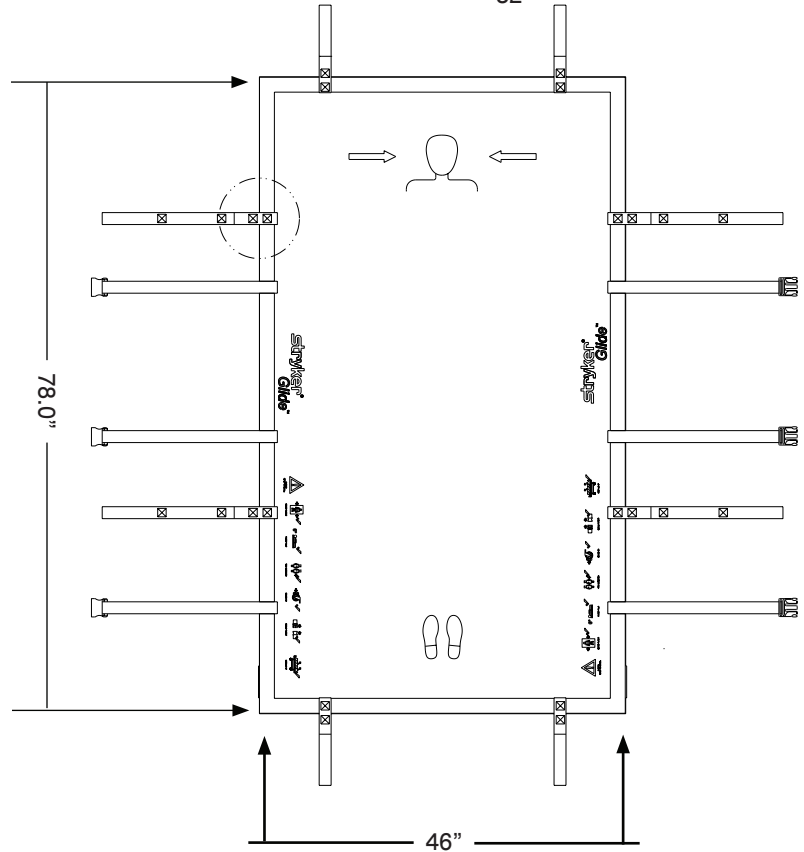

# Tote Assembly - 3060-001-041

---

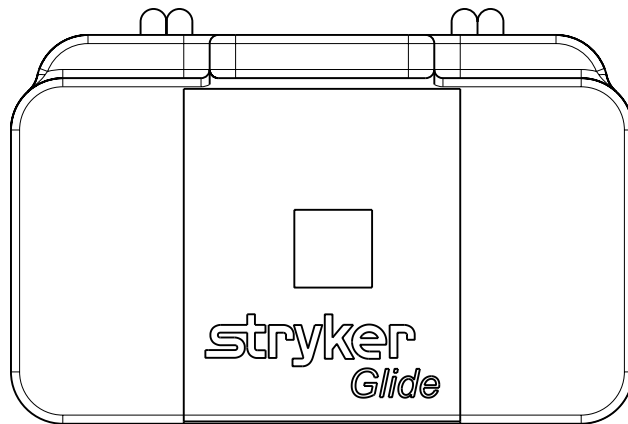
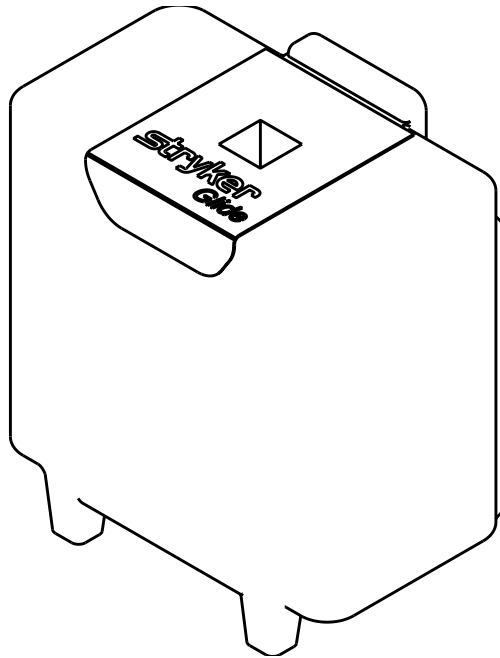

# Warranty

---

## LIMITED WARRANTY

Stryker Medical Division, a division of Stryker Corporation, warrants to the original purchaser the GLIDE™ to be free from defects in material and workmanship for a period of one (1) year after date of delivery. Stryker's obligation under this warranty is expressly limited to supplying replacement parts and labor for, or replacing, at its option, any product which is, in the sole discretion of Stryker, found to be defective. If requested by Stryker, products or parts for which a warranty claim is made shall be returned prepaid to the factory. Any improper use or any alteration or repair by others in such manner as in Stryker's judgment affects the product materially and adversely shall void this warranty. Any repair of Stryker products using parts not provided or authorized by Stryker shall void this warranty. No employee or representative of Stryker is authorized to change this warranty in any way.

Stryker Medical's GLIDE™ product is designed for an expected service life as listed below under normal use, conditions, and with appropriate periodic maintenance as described in the maintenance manual for each device.

- Blower Assembly: Five (5) years
- Matt Assembly: Two (2) years
- Tote Assembly: Five (5) years

This statement constitutes Stryker's entire warranty with respect to the aforesaid equipment. **Stryker makes no other warranty or representation, either expressed or implied, except as set forth herein. There is no warranty of merchantability and there are no warranties of fitness for any particular purpose. In no event shall Stryker be liable here under for incidental or consequential damages arising from or in any manner related to sales or use of any such equipment.**

## TO OBTAIN PARTS AND SERVICE

Stryker products are supported by a nationwide network of dedicated Stryker Field Service Representatives. These representatives are factory trained, available locally, and carry a substantial spare parts inventory to minimize repair time. Simply call your local representative, or call Stryker Customer Service USA at 1-800-327-0770, Canada 1-888-233-6888.

## RETURN AUTHORIZATION

Merchandise cannot be returned without approval from the Stryker Customer Service Department. An authorization number will be provided which must be printed on the returned merchandise. Stryker reserves the right to charge shipping and restocking fees on returned items. **Special, modified, or discontinued items not subject to return.**

## DAMAGED MERCHANDISE

ICC Regulations require that claims for damaged merchandise must be made with the carrier within fifteen (15) days of receipt of merchandise. **Do not accept damaged shipments unless such damage is noted on the delivery receipt at the time of receipt.** Upon prompt notification, Stryker will file a freight claim with the appropriate carrier for damages incurred. Claim will be limited in amount to the actual replacement cost. In the event that this information is not received by Stryker within the fifteen (15) day period following the delivery of the merchandise, or the damage was not noted on the delivery receipt at the time of receipt, the customer will be responsible for payment of the original invoice in full. Claims for any short shipment must be made within thirty (30) days of invoice.

# EMC Information

## GLIDE™

<b>Guidance and Manufacturer's declaration - Electromagnetic Immunity</b>			
The GLIDE™ is suitable for use in the electromagnetic environment specified below. The customer or the user of the GLIDE™ should assure that it is used in such an environment.			
<b>Immunity Test</b>	<b>IEC 60601 Test Level</b>	<b>Compliance Level</b>	<b>Electromagnetic Environment Guidance</b>
Electrostatic Discharge (ESD) IEC 61000-4-2	±6 kV contact ±8 kV air	±6 kV contact ±8 kV air	Floors should be wood, concrete, or ceramic tile. If floors are covered with synthetic material, the relative humidity should be at least 30%.
Electrostatic fast Transient/burst IEC61000-4-4	±2 kV for power supply lines ±1 kV for input/output lines	±2 kV for power supply lines ±1 kV for input/output lines	Main power quality should be that of a typical commercial or hospital environment.
Surge IEC 61000-4-5	±8 kV differential mode ±2 kV common mode	±8 kV differential mode ±2 kV common mode	Main power quality is that of a typical commercial and/or hospital environment.
Voltage dips, voltage variations and short interruptions on power supply input lines IEC 61000-4-11	<5%Ut (95% dipUt) for 0,5 cycle 40%Ut (60% dop in Ut) for 5 cycles 70%Ut (30% dip in Ut) for 25 cycles. <5% Ut (>95% dip in Ut) for 5 sec.	<5%Ut (95% dipUt) for 0,5 cycle 40%Ut (60% dop in Ut) for 5 cycles 70%Ut (30% dip in Ut) for 25 cycles. <5% Ut (>95% dip in Ut) for 5 sec.	Main power quality should be that of a typical commercial and/or hospital environment. If the user of the GLIDE™ requires continued operation during power main interruptions, it is recommended that the device be powered from an uninterrupted power supply or a battery.
Power frequency (50/60 Hz) magnetic field IEC 61000-4-8	3 A/m	3 A/m	Power frequency magnetic fields should be at levels characteristic of a typical location in a typical commercial and/or hospital environment.
Note: $U_T$ is the a.c. mains voltage prior to applications of the test level.			

# EMC Information

## GLIDE™ (CONTINUED)

Recommended separation distances between portable and mobile RF communications equipment and the GLIDE™.			
The GLIDE™ is intended for use in an electromagnetic environment in which radiated RF disturbances are controlled. The customer or the user of the GLIDE™ can help prevent electromagnetic interferences by maintaining a minimum distance between portable and mobile RF communications equipment (transmitters) and the GLIDE™ as recommended below, according to the maximum output power of the communications equipment.			
Rated maximum output power of transmitter W	Separation distance according to frequency of transmitter m		
	150 kHz to 80 MHz $\sqrt{P}$ d=1,2	80 MHz to 800 MHz $\sqrt{P}$ d=1,2	8000 MHz to 2,5 GHz $\sqrt{P}$ d=2,3
0,01	1,12	0,12	0,23
0,1	0,38	0,38	0,73
1	1,2	1,2	2,3
10	3,8	3,8	7,3
100	12	12	23
For transmitters rated at a maximum output power not listed above, the recommended separation distance $d$ in meters (m) can be estimated using the equation applicable to the frequency of the transmitter, where $P$ is the maximum output power rating of the transmitter in watts (W) according to the transmitter manufacturer.			
<b>NOTE 1</b> At 80 MHz and 800 MHz, the separation distance for the higher frequency range applies.			
<b>NOTE 2</b> These guidelines may not apply in all situations. Electromagnetic propagation is affected by absorption and reflection from structures, objects and people.			

# EMC Information

## GLIDE™ (CONTINUED)

The GLIDE™ is suited for use in the electromagnetic environment specified below. The customer or the user of the GLIDE™ should assure that it is used in such an environment.

Immunity Test	IEC 60601 Test Level	Compliance Level	Electromagnetic Environment - Guidance
<p style="text-align: center;">Conducted RF IEC 6100-4-6</p> <p style="text-align: center;">Radiated RF IEC 61000-4-3</p>	<p style="text-align: center;">3 Vrms 150 kHz to 80 MHz</p> <p style="text-align: center;">3 V/m 80 MHz to 2,5 GHz</p>	<p style="text-align: center;">3 Vrms</p> <p style="text-align: center;">3 V/m</p>	<p>Portable and mobile RF communications equipment should be used no closer to any part of the GLIDE™, including cables, than the recommended separation distance calculated from the equation appropriate for the frequency of the transmitter.</p> <p style="text-align: center;">Recommended Separation Distance</p> <p style="text-align: center;">d=1,2</p> <p style="text-align: center;"><math>\sqrt{P}</math></p> <p style="text-align: center;">d=1,2</p> <p style="text-align: center;"><math>\sqrt{P}</math></p> <p style="text-align: center;">80 MHz to 800 MHz</p> <p style="text-align: center;">d=2,3</p> <p style="text-align: center;"><math>\sqrt{P}</math> </p>

**NOTE 1**

At 80 MHz and 800 MHz, the higher frequency range applies.

**NOTE 2**

These guidelines may not apply in all situations. Electromagnetic propagation is affected by absorption and reflection from structures, objects and people.

<sup>a</sup>Field strengths from fixed transmitters, such as base stations for radio (cellular/cordless) telephones and land mobile radios, amateur radio, AM and FM radio broadcast, and TV broadcast cannot be predicted theoretically with accuracy. To assess the electromagnetic environment due to fixed RF transmitters, an electromagnetic site survey should be considered. If the measured field strength in the location in which the GLIDE™ is used exceeds the applicable RF compliance level above, the GLIDE™ should be observed to verify normal operation. If abnormal performance is observed, additional measures may be necessary, such as reorienting or relocating the GLIDE™.

<sup>b</sup>Over the frequency range 150 kHz to 80 MHz, field strengths are less than 3 V/m.

# EMC Information

## GLIDE™ (CONTINUED)

<b>Guidance and Manufacturer's declaration - Electromagnetic Emissions</b>		
The GLIDE™ is intended for use in an electromagnetic environment specified below. The customer or the user of the GLIDE™ should assure that it is used in such an environment.		
<b>Emissions Test</b>	<b>Compliance</b>	<b>Electromagnetic Environment</b>
RF Emissions CISPR 11	Group 1	The GLIDE™ uses RF energy only for its internal function. Therefore, its RF emissions are very low and are not likely to cause any interference in nearby electronic equipment.
RF Emissions CISPR 11	Class A	The GLIDE™ is suitable for use in all establishments other than domestic and those directly connected to the public low voltage power supply network that supplies buildings used for domestic purposes.
Harmonic Emissions IEC 61000-3-2	Class A	
Voltage Fluctuations Flicker Emissions IEC 6100-3-3	Complies	





UNITED STATES  
Stryker Medical  
3800 E. Centre Ave.,  
Portage, Michigan USA  
49002

CANADA  
Stryker Canada  
45 Innovation Drive  
Hamilton, Ontario Canada  
L9H 7L8

EC	REP
----	-----

**European Representative**  
Stryker France  
ZAC Satolas Green Pusignan  
Av. De Satolas Green  
69881 MEYZIEU Cedex  
France

**stryker**<sup>®</sup>