

Spirit Behavioral Health Platform Bed

Operations Manual

REF 5800-100-100

REF 5800-100-110

REF 5800-100-120

REF 5800-100-130

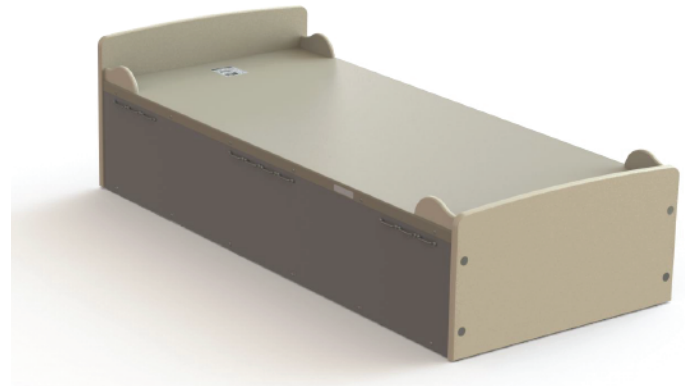

Symbols









	Refer to instruction manual/booklet
	Consult instructions for use
	General warning
	Caution
	Catalogue number
	Serial number
	Manufacturer
	Safe working load
MADE IN U.S.A.	Product made in the United States of America

Table of Contents

Warning/Caution/Note Definition	2
Summary of safety precautions	2
Introduction	3
Product description	3
Indications for use	3
Contraindications	3
Expected service life	3
Disposal/recycle	3
Specifications	4
Compatibility	5
Contact information	5
Serial number location	5
Setup	6
Cleaning and disinfecting with SideKick®	7
Cleaning	8
Preventive maintenance	8

Warning/Caution/Note Definition

The words **WARNING**, **CAUTION**, and **NOTE** carry special meanings and should be carefully reviewed.

WARNING

Alerts the reader about a situation which, if not avoided, could result in death or serious injury. It may also describe potential serious adverse reactions and safety hazards.

CAUTION

Alerts the reader of a potentially hazardous situation which, if not avoided, may result in minor or moderate injury to the user or patient or damage to the product or other property. This includes special care necessary for the safe and effective use of the device and the care necessary to avoid damage to a device that may occur as a result of use or misuse.

Note - Provides special information to make maintenance easier or important instructions clearer.

Summary of safety precautions

Always read and strictly follow the warnings and cautions listed on this page. Service only by qualified personnel.

WARNING

- Do not overload the product. The combined weight of patients, visitors, mattress, additional equipment, accessories, and bedding should not exceed 1,000 lb (454 kg).
- Always attach, adjust, and use patient restraints by qualified healthcare practitioners only. Only use patient restraints if medically necessary to safeguard the wellbeing of the patient or staff.
- Always attach and adjust patient restraints to avoid serious injury or death. Possible entrapment, suffocation, and asphyxiation hazards exist when you use patient restraints of any type on the product.
- Always use the product with a mattress that has a thickness of at least 6 in. (152 mm).
- Always fit the mattress between the headboard and footboard on the mattress deck.
- Always fit the mattress within the mattress keepers.
- Always make sure that the mattress has a **GRIP-EX** bottom material or equivalent.
- Always perform a patient assessment to make sure that the bed and mattress selection meet patient needs.
- Always have a qualified healthcare practitioner frequently monitor the patient.
- Always complete a patient entrapment and fall risk assessment for every mattress used on the product.
- Do not attempt to lower the product without assistance. Use at least two people to lower the product.
- Always keep your hands on the product as you unpack. Secure the product when you unpack, so the product does not fall.
- Do not drop the product to avoid permanent damage to components.
- Do not use a product that has been dropped. Damage may have occurred that could result in injury to staff and patients.

CAUTION

- Improper usage of the product can cause injury to the patient or operator. Operate the product only as described in this manual.
 - Do not modify the product or any components of the product. Modifying the product can cause unpredictable operation resulting in injury to patient or operator. Modifying the product also voids its warranty.
 - Do not use solvents, alcohol, or petroleum products on the surface of the product.
 - Do not steam clean or pressure wash.
 - Do not submerge the bed frame. Clean up any spilled liquid on or around the product. Allow the product and area around the product to dry before use.
 - Always make sure that all fasteners are tight before you return the product to service.
 - Do not clean, disinfect, service, or perform maintenance while the product is in use.
-

Introduction

This manual assists you with the operation or maintenance of your Stryker product. Read this manual before operating or maintaining this product. Set methods and procedures to educate and train your staff on the safe operation or maintenance of this product.

CAUTION

- Improper usage of the product can cause injury to the patient or operator. Operate the product only as described in this manual.
 - Do not modify the product or any components of the product. Modifying the product can cause unpredictable operation resulting in injury to patient or operator. Modifying the product also voids its warranty.
-

Note

- This manual is a permanent part of the product and should remain with the product even if the product is sold.
- Stryker continually seeks advancements in product design and quality. This manual contains the most current product information available at the time of printing. There may be minor discrepancies between your product and this manual. If you have any questions, contact Stryker Customer Service or Technical Support at 1-800-327-0770.

Product description

The Spirit Behavioral Health Platform Bed is a manual, non-adjustable bed that is used in combination with a patient support surface. The product has a litter surface consisting of a single platform supported by two sidewalls, headboard, and footboard. The product is designed with features such as rubber feet, restraint loops, four corner mattress keepers, 1000 lb (454 kg) weight capacity, 36 inch width, and 16 inch height from floor to litter top. The product can accommodate mattress lengths of 80 or 84 inches. The product is made with tamper-resistant hardware, durable high-density polyethylene material, and powder-coated HR plate steel.

Indications for use

The Spirit Behavioral Health Platform Bed is intended to be used to assist with therapy, recovery, and support of behavioral health patients within a healthcare delivery organization (HDO). The intended users for this product are healthcare professionals (HCPs: nurses, nurses' aides, and medical doctors) and human patients. The product can be used with behavioral health patients with a height up to 84 inches. The safe working load for the bed is 1,000 lb (454 kg). This product is intended to be used with patients in an HDO setting.

Contraindications

None known.

Expected service life

The Spirit Behavioral Health Platform Bed has a five year expected service life under normal use conditions and with appropriate periodic maintenance.

Disposal/recycle

Always follow the current local recommendations and/or regulations governing environmental protection and the risks associated with recycling or disposing of the equipment at the end of its useful life.

Specifications

WARNING

- Do not overload the product. The combined weight of patients, visitors, mattress, additional equipment, accessories, and bedding should not exceed 1,000 lb (454 kg).
- Always attach, adjust, and use patient restraints by qualified healthcare practitioners only. Only use patient restraints if medically necessary to safeguard the wellbeing of the patient or staff.
- Always attach and adjust patient restraints to avoid serious injury or death. Possible entrapment, suffocation, and asphyxiation hazards exist when you use patient restraints of any type on the product.

	Safe working load ¹		1,000 lb	454 kg
	Note - Safe working load indicates the sum of the patient, visitors, equipment, accessories, bedding, and mattress weight.			
Length - between headboard and footboard	5800-100-100, 5800-100-120	79.5 in.	2,019 mm	
	5800-100-110, 5800-100-130	83.5 in.	2,121 mm	
Width - mattress platform	36 in.	914 mm		
Height - mattress platform to floor ²	16 in.	406 mm		
Weight - empty bed	Smallest configuration	79.5 in. x 36 in. x 16 in.	2,019 mm x 914 mm x 406 mm	300 lb (136 kg)
	Largest configuration	83.5 in. x 36 in. x 16 in.	2,121 mm x 914 mm x 406 mm	380 lb (172 kg)
Materials				
Headboard and footboard	1" HDPE			
Side panels	3/8" HDPE			
Platform	11 GA, HR sheet steel, powder coated			
Frame	14 GA, HR steel tubing, powder coated			
Four corner mattress keepers	3/4" HDPE			
Ratings				
Load rating (each point) ³	Side panel restraint points	150 lb	68 kg	

¹Safe working load evenly distributed as per Figure 102, IEC 60601-2-38, point loading not permitted.

²Height is measured in 2 in. (50.8 mm) increments. Height of product with mattress included is 22 in. (559 mm).

³Impact loading not considered. Cumulative restraint point loading shall not exceed the safe working load of the product.

Stryker reserves the right to change specifications without notice.

Specifications listed are approximate and may vary slightly from product to product.

Compatibility

A mattress is not included but is recommended for use with the **Spirit** Behavioral Health Platform Bed. The length and width of the mattress must fit the mattress deck and be at least 6 in. (152 mm) thick.

WARNING

- Always use the product with a mattress that has a thickness of at least 6 in. (152 mm).
 - Always fit the mattress between the headboard and footboard on the mattress deck.
 - Always fit the mattress within the mattress keepers.
 - Always make sure that the mattress has a **GRIP-EX** bottom material or equivalent.
 - Always perform a patient assessment to make sure that the bed and mattress selection meet patient needs.
 - Always have a qualified healthcare practitioner frequently monitor the patient.
 - Always complete a patient entrapment and fall risk assessment for every mattress used on the product.
-

Contact information

Contact Stryker Customer Service or Technical Support at: 1-800-327-0770.

Stryker Medical
3800 E. Centre Avenue
Portage, MI 49002
USA

Note - The user and/or the patient should report any serious product-related incident to both the manufacturer and the Competent authority of the European Member State where the user and/or patient is established.

To view your operations or maintenance manual online, see <https://techweb.stryker.com/>.

Have the serial number (A) of your Stryker product available when calling Stryker Customer Service or Technical Support. Include the serial number in all written communication.

Serial number location

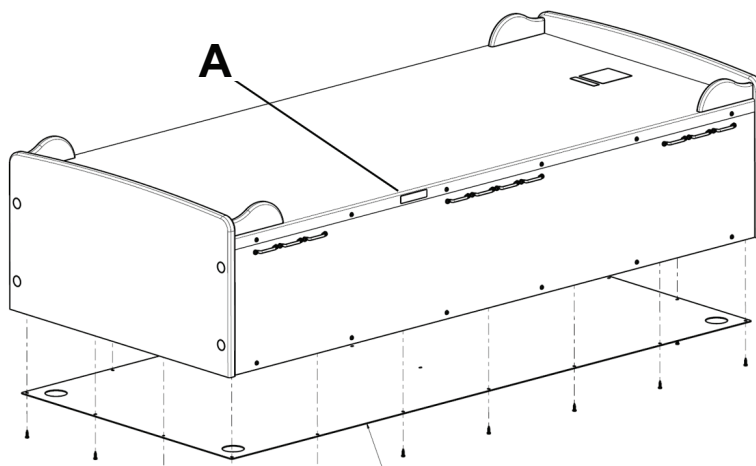

Figure 1 – Serial number location

Setup

During setup, unpack the cartons and check all items for proper operation. Confirm proper operation before you place the product into service.

WARNING

- Do not attempt to lower the product without assistance. Use at least two people to lower the product.
 - Always keep your hands on the product as you unpack. Secure the product when you unpack, so the product does not fall.
 - Do not drop the product to avoid permanent damage to components.
 - Do not use a product that has been dropped. Damage may have occurred that could result in injury to staff and patients.
-

The product may be shipped vertically on a skid. Follow the procedure below to lower the product from an upright position:

1. Cut all shipping straps that secure the products together (Figure 2).
2. Slide one product away from the other so they do not touch (Figure 3).
3. Remove the bags from each product (Figure 4).
4. Rotate the product so the frame is accessible (Figure 5).

Note - Leave at least eight feet of space before you lower the product to the floor from the upright position.



Figure 2 –



Figure 3 –



Figure 4 –



Figure 5 –

5. Use a piece of cardboard to protect the lower edge of the product from scratching (Figure 6).
6. Walk the product so it hangs over the edge of the shipping skid (Figure 6).
7. To lower the product, pull from the upright position and slowly walk backward (Figure 7).

Note - You may need to reposition your grip as you lower the product. Communicate with the other person before you adjust your grip.

8. Maintain your grip, lock your arms, and bend your knees to lower the product (Figure 8).



Figure 6 –



Figure 7 –



Figure 8 –

Cleaning and disinfecting with SideKick®

For United States only. Confirm availability for your configuration or region. Call Stryker Customer Service: 1-800-327-0770.

Stryker's preferred wipes (2060-000-001 6" x 10" or 2060-000-002 9" x 12") and spray (2070-000-001) include the following active ingredients:

- n-Alkyl (60% C14, 30% C16, 5% C12, 5% C18) dimethyl benzyl ammonium chloride - 0.154%
- n-Alkyl (68% C12, 32% C14) dimethyl ethylbenzyl ammonium chloride - 0.154%
- Isopropanol - 21.000%

Non-active ingredient: Ethylene Glycol Monobutyl Ether – < 3%

Note - For safety information, read the product label.

To clean or disinfect the external product surface with SideKick wipe:

To clean:

1. Wipe down the external product surface with a fresh, clean wipe to remove all visible soils.
2. Repeat as necessary until the external product surface is visibly clean.
3. Wipe dry with a cloth or allow the external product surface to air dry before you return the product to service.

Note - Use as many wipes as necessary.

To disinfect:

1. Clean first.
2. Wipe down the external product surface with a fresh, clean wipe until wet.
3. Allow the external product surface to remain wet for two minutes at room temperature.
4. Wipe dry with a cloth or allow the external product surface to air dry before you return the product to service.

To clean or disinfect the external product surface with SideKick spray:

To clean:

1. Spray **SideKick** on a mop, sponge, paper cloth, or cloth towel.
2. Wipe down the external product surface with a fresh, clean mop, sponge, paper cloth, or cloth towel to remove all visible soils.
3. Repeat as necessary until the external product surface is visibly clean.
4. Wipe dry with a cloth or allow the external product surface to air dry before you return the product to service.

To disinfect:

1. Clean first.
2. Spray **SideKick** on a mop, sponge, paper cloth, or cloth towel.
3. Wipe down the external product surface with a fresh, clean mop, sponge, paper cloth, or cloth towel until wet.
4. Allow the external product surface to remain wet for two minutes at room temperature.
5. Wipe dry with a cloth or allow the external product surface to air dry before you return the product to service.

Note - Follow your hospital protocols to launder cloth towels or dispose of wipes or papers cloths.

Cleaning

CAUTION

- Do not use solvents, alcohol, or petroleum products on the surface of the product.
 - Do not steam clean or pressure wash.
 - Do not submerge the bed frame. Clean up any spilled liquid on or around the product. Allow the product and area around the product to dry before use.
 - Always make sure that all fasteners are tight before you return the product to service.
 - Do not clean, disinfect, service, or perform maintenance while the product is in use.
-

The recommended cleaners for this product's surfaces include the following:

- Quaternary (active ingredient – ammonium chloride) less than 3% glycol ether
- Phenolic (active ingredient - o-phenylphenol)
- Chlorinated bleach solution (10,000 ppm available chlorine, 941 mL of a 5.25% sodium hypochlorite solution per 4000 mL of water)
- Alcohol (active ingredient - 70% isopropyl alcohol)

Recommended cleaning method:

1. Hand wash all exposed surfaces of the product with a mild detergent spray or pre-soaked wipes.
2. Follow the cleaning solution manufacturer's instructions for appropriate contact time and rinse requirements.
3. Dry the product.
4. Verify proper operation before you return the product to service.

Note - Avoid oversaturation. Do not allow the product to remain wet.

Preventive maintenance

Remove the product from service before you perform the preventive maintenance inspection. Check all items listed during annual preventive maintenance for all Stryker products. You may need to perform preventive maintenance checks more often based on your level of product usage. Service only by qualified personnel.

Note - Clean and disinfect the exterior of the product before inspection, if applicable.

Inspect the following items:

- _____ No loose or missing fasteners
- _____ No sharp or bent edges in top litter deck metal panel
- _____ No damaged or missing rubber foot pads
- _____ No bent, loose, damaged, or missing patient restraints
- _____ No loose, damaged, or missing four corner mattress keepers
- _____ No loose or missing HDPE panels
- _____ No cracks or splits in headboard, footboard, or side panels
- _____ No scratches or chips in powder coating of metal components, use enamel touch up paint if necessary

Product serial number:
Completed by:
Date:

stryker



Stryker Medical
3800 E. Centre Avenue
Portage, MI 49002
USA