

Thermacare® TC3001

Convective Warming System

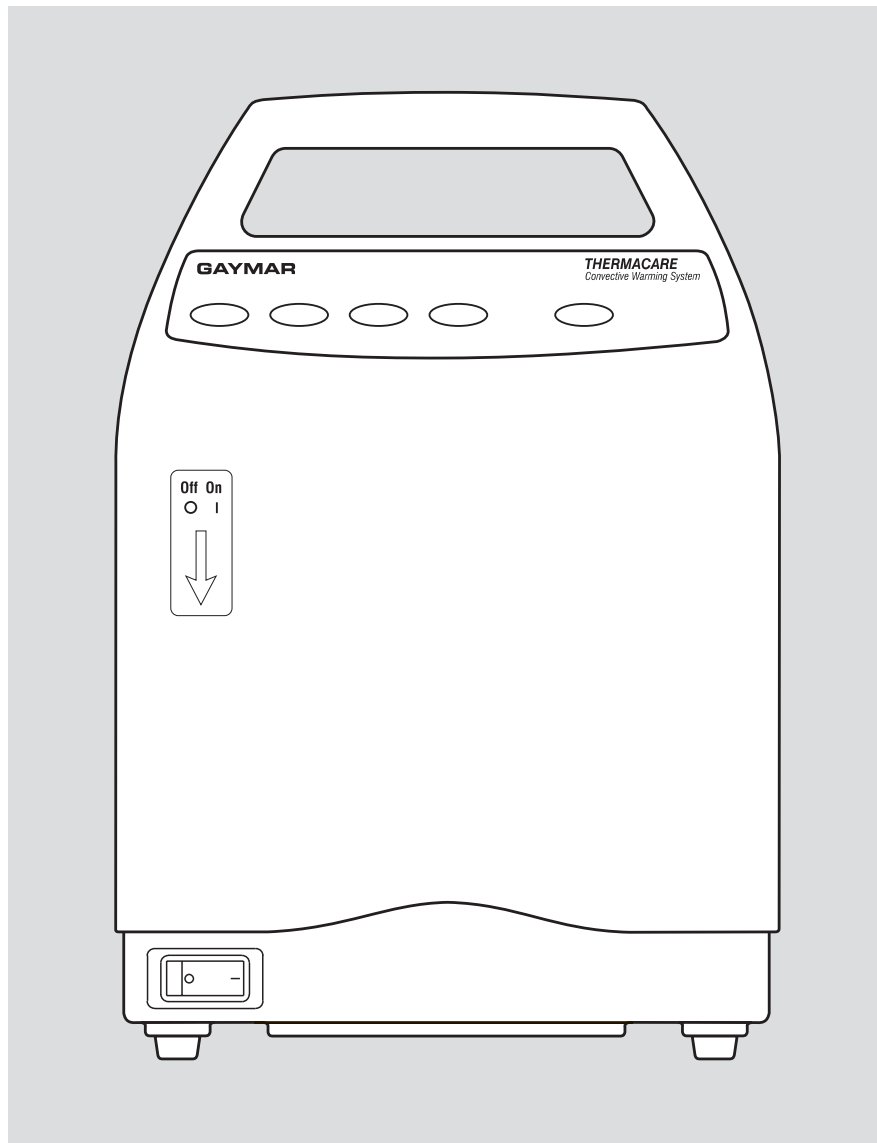

Operating Manual

Before you begin . . .

Important

The Thermacare TC3001 Convective Warming Unit is compatible with model TC1050, TC1050N, TC2050, TC2050N, TC2052, TC2052N, TC2054, TC2054N, TC2060 and TC2061 Warming Quilts.

The Thermacare Convective Warming System (figure 1, page 4) provides a continuous means of warming patients to help prevent and/or treat hypothermia. The system consists of a Convective Warming Unit (Power Unit) and a disposable Quilt. A connecting hose conducts heated air from the Power Unit to the Quilt.

Read and understand the *Operator's Manual* and all precautions prior to using the TC3001 Convective Warming System.

We suggest that a biomedical engineer perform the *FUNCTIONAL CHECK AND SAFETY INSPECTION* regularly to assure the TC3001 Power Unit works properly (refer to *TC3001 Service Manual*).

Review the *SAFETY PRECAUTIONS* in section 1.0 (pp. 2-3) prior to each application.

Receiving Inspection

Upon receipt, unpack the Power Unit. Save all packing material. Perform a visual and mechanical inspection for concealed damage. If any damage is found, notify the carrier at once and ask for a written inspection. Photograph any damage and prepare a written record. Failure to do so within 15 days may result in loss of claim.

Contact your local dealer for assistance.

NOTE: Extremely high storage temperatures (such as those found in rail cars or automobile trunks on hot summer days) can cause the overtemp thermostats within this device to actuate. Should this occur, the *REMOVE FROM USE* indicator will light when the Power Unit is turned on. If this happens, the thermostats must be manually reset by qualified personnel such as certified biomedical electronics technicians

© 1997. Gaymar Industries, Inc. All rights reserved. Gaymar trademark is registered in U. S. Patent and Trademark Office.

Symbols used within this manual:



Attention: consult accompanying documents



Dangerous voltage



Protective earth (ground)



Type BF applied equipment

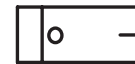

Off-on switch



Fan only (no heat)



32°C



38°C



43°C



46°C



REMOVE FROM USE
(indicator light, amber color)



Do not use in operating room
(OR) or Intensive Care Unit (ICU)



Ambient operating temperature

Table of Contents

Table of Contents

<i>Section</i>	<i>Description</i>	<i>Page</i>
1.0	Safety Precautions	2
2.0	Introduction	4
3.0	Operator Control Panel	5
4.0	Operating Instructions	6
5.0	Routine Maintenance.....	7
6.0	Troubleshooting	8
7.0	Quilts / Training / Warranty / Returns	8
8.0	Specifications	9

Illustrations

<i>Figure</i>	<i>Description</i>	<i>Page</i>
1	Convective Warming System.....	4
2A/2B	Power Unit Mounting.....	4
3	Pole Mounting Height Limit.....	4
4	Operator Control Panel	5
5	Attaching Hose to Quilt.....	6

Tables

<i>Table</i>	<i>Description</i>	<i>Page</i>
1	Setting the Prescribed Temperature	6

Section 1 - Safety Precautions

1.0 Safety Precautions

Review the following *SAFETY PRECAUTIONS* prior to using the Power Unit. These *SAFETY PRECAUTIONS* appear within this manual, the Power Unit label, or the *Quilt Instructions for Use*.



DANGER

- Explosive hazard. Do not use in the presence of flammable anesthetics.
- Risk of electric shock. Disconnect power before servicing the TC3001 Power Unit.



WARNING

This device generates heated air flow. Excessive heat could cause thermal stress or skin lesions. Failure to follow these precautions could result in death or serious injury:

- Use this system only under direction of a physician. A physician's order is required for setting temperature and for continued use of equipment.
- If the patient's temperature is not responding or does not reach the prescribed temperature in the prescribed time, or deviates from the prescribed temperature range, notify the attending physician promptly.
- Monitor core temperature. Neonates and pediatric patients of low weight will have a tendency to overheat more readily than adults. Failure to monitor core temperature could result in abnormal elevation of body temperature resulting in death or serious injury.
- Monitor the patient's temperature, vital signs, and skin condition regularly (every 20 minutes or as prescribed by a physician). Pediatric, temperature-sensitive, and postoperative patients should be checked more frequently. If the patient's temperature is

(continued next column)



WARNING

within the prescribed range, select a lower temperature setting or discontinue therapy. If vital signs become unstable, notify the attending physician immediately.

- When treating hemodynamically unstable patients, start therapy at 32°C or 38°C temperature setting.
- Do not apply heat to lower extremities during aortic cross-clamping. Ischemic injury may occur.
- Do not use the 46°C temperature setting in the operating room.
- Do not use the TC3001 Power Unit in the 46°C temperature setting when using the TC2050, TC2050N, TC2052, TC2052N, TC2054, TC2054N, TC2060 or TC2061 Warming Quilts.
- Do not use the 46°C temperature setting for patients with any of the following conditions:
 1. Low cardiac output
 2. Poor peripheral perfusion or peripheral vascular disease
 3. Total immobilization
 4. Non-sensate patients
- Do not apply heat to ischemic tissue.
- Do not use the Power Unit unless the hose is connected to a warming quilt. Place your hand under the quilt to verify the air is warm.
- Use this Power Unit only with those quilts recommended by the manufacturer (see inside cover of this manual for list).
- Repairs should be performed only by qualified personnel such as certified biomedical electronics technicians or certified clinical engineers familiar with repair practices for servicing medical devices, and in accordance with the *Service Manual*. **Damage to the Power Unit or malfunction could otherwise**

Section 1 - Safety Precautions (cont'd)

1.0 Safety Precautions (cont'd)



CAUTION

- **U. S. Federal law restricts this device to sale by or on the order of a physician.**
- Evaporative cooling may result if the patient's skin is not dry.
- Convective airflow can cause airborne contamination to open wounds if they are not covered.
- For grounding reliability, plug only into a properly grounded outlet.
- When using an I. V. pole, do not mount the Power Unit higher than 1 meter. Otherwise, the Power Unit could tip over.

Section 2 - Introduction

2.0 Introduction

Please read the precautions found in section 1.0 and all operating instructions before attempting to use the Thermacare TC3001 Convective Warming System. In addition, we recommend you request in-service training from your local dealer.

2.1 Convective Warming System

The **Convective Warming System** (fig. 1) provides a continuous means of warming patients to help prevent and/or treat hypothermia. The system consists of a Convective Warming Unit (Power Unit) and a disposable Quilt. A connecting hose conducts heated air from the Power Unit to the Quilt.

2.2 TC3001 Power Unit

The **TC3001 Power Unit** provides a continuous source of air to the Quilt. The Power Unit consists of a HEPA filter, blower, heater, and temperature controller. Exiting air temperatures may be set to one of five temperature settings -- *fan only*, 32°C , 38°C , 43°C , and 46°C -- as appropriate for the application. The Power Unit can be operated while hanging on the rails of a bed, stretcher, on an I. V. pole, or on an optional stand (figs. 2A/2B).



CAUTION

When using an I. V. pole, do not mount the Power Unit higher than 1 meter (see fig. 3).
Otherwise, the Power Unit could tip over.

2.3 Quilt

The **Quilt** distributes air over the covered areas of the patient through openings in the patient side of the Quilt. Quilts consist of layers of plastic and nonwoven material bonded together. On operating room model Quilts, a pressure-sensitive, nonirritating tape provides a seal between the air from the Quilt and the surgical site. **Refer to the instructions enclosed with each Quilt.**

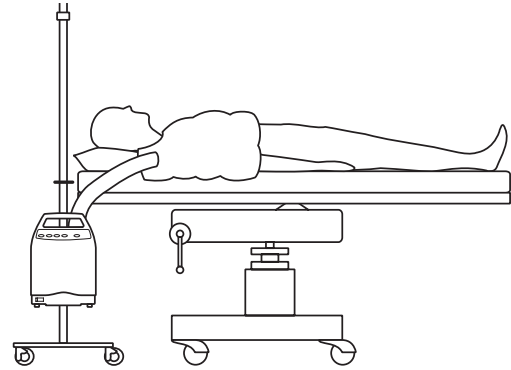

Figure 1 - Convective Warming System

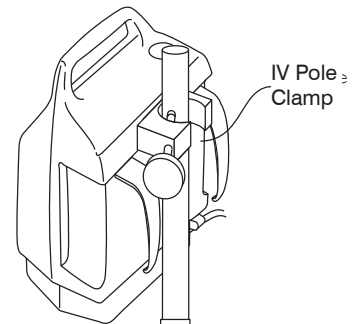

Figure 2A - I. V. Pole or Stand mounted

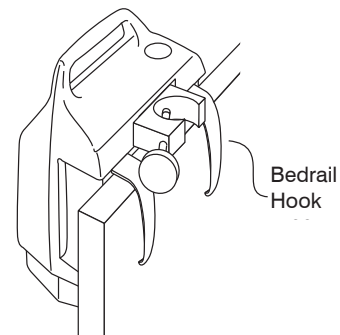

Figure 2B - Bed rail mounted

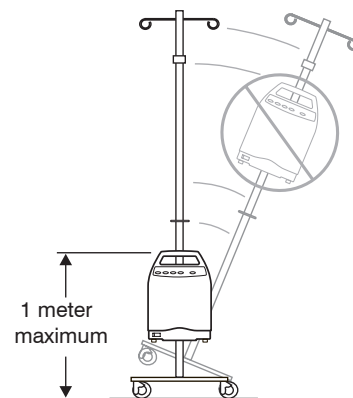

Figure 3 - Pole mounting height limit

Section 3 - Operator Control Panel

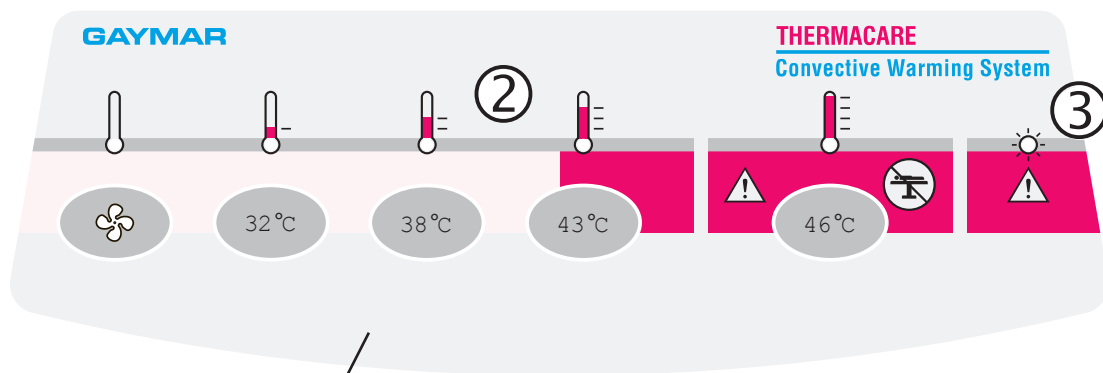
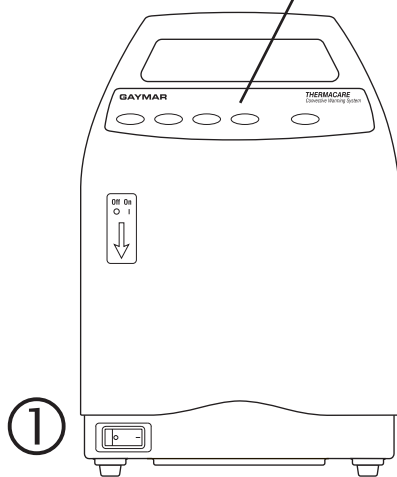

Figure 4 - Operator Control Panel



3.0 Operator Control Panel

The operator controls are identified in figure 4.

3.1 POWER Switch ①

The *POWER* switch controls power to the Power Unit. The *POWER INDICATOR* light in the switch will be lit when power is on.

3.2 TEMPERATURE SETTING

Push Buttons ②

When the Power Unit is turned on, the system defaults to the 32°C temperature setting.

Temperature settings are selected by pressing the appropriate push button-- *fan only*, 32°C, 38°C, 43°C, or 46°C.

If electrical power is momentarily interrupted, the existing temperature setting will remain. If electrical power remains off, the TC3001 will default to 32°C when power is restored.

⚠ WARNING

Failure to follow the following precautions could result in death or serious injury:

- Do not use the 46°C setting in the operating room.
- Do not use the 46°C setting for patients with any of the following conditions:
 1. Low cardiac output
 2. Poor peripheral perfusion or peripheral vascular disease
 3. Total immobilization
 4. Non-sensate patients

3.3 REMOVE FROM USE Indicator ③

The *REMOVE FROM USE* indicator will light:

- if a patient limit thermostat or heater overtemp thermostat has tripped, or
- if the HEPA filter has been installed incorrectly or is missing.

The heating element and blower will automatically turn off when either of these conditions occur.

⚠ CAUTION

If the *REMOVE FROM USE* indicator lights, turn the Power Unit off immediately. Discontinue use and refer equipment for servicing.

Section 4 - Operating Instructions

IMPORTANT

Read and understand these instructions and the precautions on the inside front cover before using the TC3001 Power Unit.

- Turn the power on.
- When the Power Unit is turned on, it defaults to the 32°C setting. Select the prescribed temperature you desire for the patient (see table 1).

4.0 Operating Instructions

Perform the following start-up procedure each time the TC3001 Convective Warming System is placed into operation:

- Select the location for operation of the TC3001 Power Unit. Mount it using the bed rail hooks, pole clamp, or set it on a flat, hard surface. If mounting unit to an I. V. pole, insure unit is mounted no higher than 1 meter. Keep the air inlets at the bottom of the unit clear of any obstructions. Do not set unit on a bed surface.
NOTE: If Power Unit is placed on the floor, increased levels of dust could reduce filter life.
- Remove the Quilt from its packaging. Unfold the Quilt and place it over the patient. Refer to the *Instructions for Use and Safety Precautions* included with each Quilt.
- Insert the end of the hose into the Quilt opening (fig. 5). Secure the hose tightly.
- Plug the Power Unit into a properly grounded outlet.





Temperature Setting	Temperature
	Fan only
	32°C
	38°C
	43°C
	46°C

Table 1 - Setting the prescribed temperature

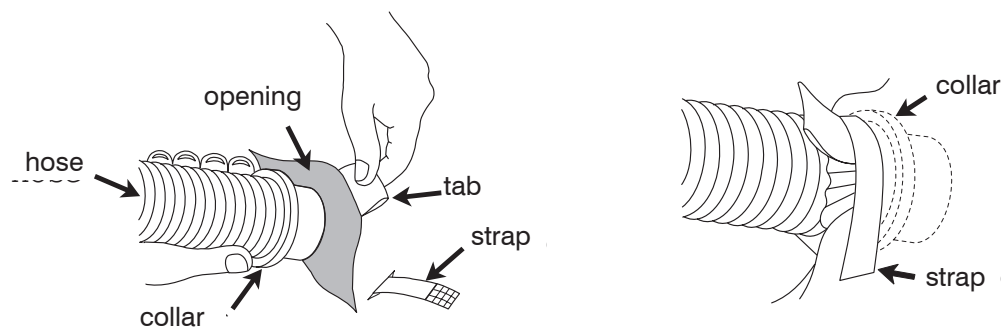



Figure 5 - Attaching hose to Quilt

Section 4 - Operating Instructions (cont'd)

Section 5 - Routine Maintenance

NOTE:

- The air temperature surrounding the patient will vary at each setting, depending upon room air temperature and the quality of the insulating blanket or sheet that is used over the Quilt.
- Operate the Power Unit only in the specified ambient temperature and voltage ranges (see *Specifications*, page 9).

 WARNING
<p>Failure to follow the following precautions could result in death or serious injury:</p> <ul style="list-style-type: none">• Do not use the 46°C setting in the operating room.• Do not use the 46°C setting for patients with any of the following conditions:<ol style="list-style-type: none">1. Low cardiac output2. Poor peripheral perfusion or peripheral vascular disease3. Total immobilization4. Non-sensate patients

7. Place your hand under the quilt to verify that the Power Unit is warming when set to the 32°C, 38°C, 43°C, or 46°C temperature settings.
8. Place a sheet or blanket over the inflated Quilt to maximize the efficiency and minimize the heat loss from the system.

 WARNING
<p>Monitor the patient's temperature, vital signs, and skin condition regularly (every 20 minutes or as prescribed by a physician). If patient's temperature reaches the normal range, reduce air temperature or discontinue therapy. If vital signs become unstable, notify the attending physician immediately. Failure to follow these precautions could result in death or serious injury.</p>

9. If the *REMOVE FROM USE* indicator lights, discontinue use. Refer servicing to qualified personnel.

4.10 Shutdown Procedure

When therapy has been completed, turn the unit off and disconnect the hose from the Quilt. Discard the Quilt.

5.0 Routine Maintenance

The following routine maintenance procedures will help insure dependable operation:

5.1 Cleaning the Power Unit

Clean the control panel, enclosure exterior, and hose with a soft cloth lightly dampened with a nonstaining hospital disinfectant. Clean accumulated dirt from the air vents with a vacuum cleaner.

5.2 Storing the Hose

Slide the hose under the bed rail hooks on the back of the Power Unit when not in use.

5.3 Storing the Power Cord

Coil the power cord. Hold it in place with the strap on the side of the Power Unit. Or, hang the power cord from the bracket on the back of the accessory stand.

5.4 Quilt Care

Refer to the instructions included with each Quilt for details on correct application and use. Small rips or tears in Quilt material may be repaired with adhesive tape.

Quilts are not sterile. Quilts are intended for single patient use only. Quilts should be discarded after use.

5.5 Servicing the Equipment

 WARNING
<p>Repairs to the Power Unit should be performed by qualified personnel such as certified biomedical electronics technicians or clinical engineers familiar with repair practices for servicing medical devices, and in accordance with the TC3001 Service Manual. Damage to the Power Unit or malfunction may otherwise result.</p>

Section 6 - Troubleshooting

Section 7 - Miscellaneous

5.6 Changing the Filter

Filters must be changed only by qualified service personnel. Refer to the *TC3001 Service Manual* for instructions on replacing the filter. Under normal use, replace the HEPA filter inside the Power Unit every 1000 operating hours or 12 months, whichever occurs first.

6.0 Troubleshooting

Most Power Unit operating problems are minor and can be corrected by the operator. The following are troubleshooting hints. Perform corrective action in the sequence listed.

6.1 Quilt Will Not Inflate

1. Make sure the Power Unit is plugged in and turned on.
2. Check both ends of hose for proper connection.
3. Check hose and quilt inlet for kinks.
4. Check Quilt for damage. If air is flowing from hose, try another Quilt. (Small rips or tears in the Quilt may be temporarily repaired with adhesive tape.)
5. Have qualified service personnel check for a clogged or dirty HEPA filter.

6.2 REMOVE FROM USE Indicator is Lit

This indicates that the heater and blower have shut down due to the air temperature exceeding the high temperature limit, or that the filter has been incorrectly installed or is missing. **Remove the Power Unit from use immediately.** Refer servicing to qualified personnel.



WARNING

Repairs to the Power Unit should be performed by qualified personnel such as certified biomedical electronics technicians or clinical engineers familiar with repair practices for servicing medical devices, and in accordance with *TC3001 Service Manual*.

Damage to the Power Unit or malfunction may otherwise result.

7.0 Miscellaneous

7.1 Quilts

Contact your dealer for information on the model TC1050, TC1050N, TC2050, TC2050N, TC2052, TC2052N, TC2054, TC2054N, TC2060 and TC2061 Quilts available for use with the TC3001 Power Unit.



WARNING

Use only quilts recommended by manufacturer. Failure to do so may result in thermal injury.

7.2 Accessory Stand

An optional accessory stand (THC5) for mounting the TC3001 Power Unit is available from your local dealer.

7.3 Customer Training

In-service training is recommended and can be arranged through your dealer.

7.4 Limited Warranty

The Thermacare TC3001 Power Unit is warranted free of defects in material and workmanship under normal use and operation for a period of two years, under the terms and conditions of the Gaymar warranty in place at time of purchase. Consumable items such as filters are excluded. The full warranty is available from Gaymar upon request.

7.5 Return Authorization

Section 8 - Specifications





8.0 Specifications

8.1 Physical

Dimensions	42 cm x 28 cm x 27 cm
Weight	6.8 kg
Enclosure	Thermoplastic
Filter	HEPA filtration to 0.3 micron particle size

8.2 Electrical

Input	100 V (nominal), 50/60 Hz, 14 amps max
Motor	1/25 HP, single phase
Heater	1200W heating element
Power Cord	15 foot, 14 AWG cord with hospital grade plug
Circuit Breaker	15 amp
Current Leakage (Earth)	100 microamps max.
Ground Resistance	0.15 ohms nominal; 0.5 ohms maximum
Ambient Operating Temperature	16°C to 29°C

Temperature Setting	Temperature
	Fan only
	32°C
	38°C
	43°C
	46°C

8.3 Temperature Settings

The air temperatures are identified on the operator control panel and indicate the average air temperature at the hose end using a Quilt.

NOTE: The air temperature around the patient is affected both by the ambient room temperature and the use of an insulating blanket on top of the Quilt.

8.4 Safety System

Dual Patient Safety Temperature Limit Thermostats

Either of two independently operating thermostats will shut off the TC3001 at a preset high limit temperature. The heater element and blower will remain off until the thermostat is manually reset.

Heater Overtemp

Heater overtemp thermostat will shut off the TC3001 in the event of a blower failure or lack of air movement. The heater element and blower will remain off until the thermostat is manually reset.

High Temp Indicator

The *REMOVE FROM USE* indicator will light on the front panel when a patient safety thermostat or heater overtemp thermostat has tripped. Also, the heating element and blower will turn off.

HEPA Filter Interlock Switch

The *REMOVE FROM USE* indicator will light on the front panel when the HEPA filter has been installed incorrectly or is missing. Also, the heating element and blower will turn off.

8.5 Quilts

All Quilts are made of a nonwoven layer bonded to a plastic film.

Quilt material meets U. S. flammability standards:

- NFPA 702 "Normal Flammability"
- CPSC Part 1632
- California Title 19, Subchapter 7

Clear drape material meets NFPA 702 "Normal Flammability."



GAYMAR INDUSTRIES, INC.

**10 Centre Drive
Orchard Park, NY 14127-2295**

**Phone:
1 800 828-7341
(716) 662-2551**

**Fax:
1 800 993-7890
(716) 662-0748**