

stryker[®] **Medical**

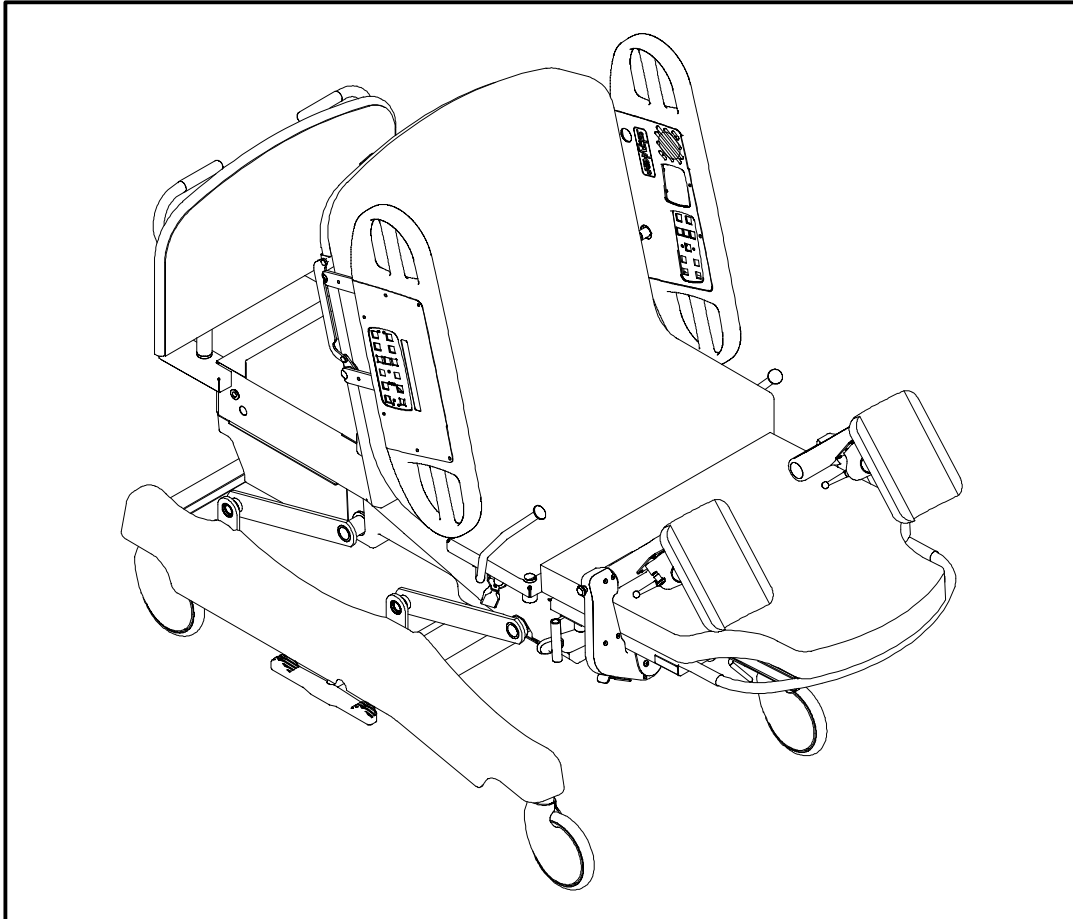

Stryker Adel[™] Maternity Bed **Model 4700 & 5012**

OPERATIONS MANUAL

For Parts or Technical Assistance
1-800-327-0770

Table of Contents

Introduction	2
Specifications	2
Warning / Caution / Note Definition	2
Bed Symbols	3
Safety Tips And Guidelines	4
Unpacking Instructions and Set-Up Procedures	5
Bed Illustration	6
Siderail Operation Guide	7-9
Pendant Operation Guide	10-12
Operating Bed Features	
Using the Brake And Steer Pedals	13
Using the Manual Motor Crank	13
Activating Instant CPR	13
Locking Out the Siderail Controls	13
Removing the Head Board	13
Using the Labor Grips	14
Adjustable Seat Depth	14
Nurse Call Battery	14
Night Light Usage	15
Operating the Foot Sections	15, 16
Lumbar and Perineal Pillows	16
Patient Positioning	
Birthing Bed Positioning	17
Birthing Chair Positioning With Labor Bar	17
Delivery Table Positioning	17
Trendelenburg Positioning	17
Pelvic Tilt	17
Using Accessories	
Using Calf Supports	18
Using the Labor Bar	18
Using the Arm Board	18
Using the CPR Board	18
Using the Permanently Attached I.V. Pole	19
Cleaning	20
Preventative Maintenance Checklist	21
Limited Warranty	
Obtaining Parts and Service	22
Supplemental Warranty Coverage	22
Return Authorization	23
Freight Damage Claims	23

Introduction

INTRODUCTION

This manual is designed to assist you with the operation of the Stryker Adel Maternity Bed. Read it thoroughly before using the equipment or beginning any maintenance on it.

SPECIFICATIONS

Maximum Weight Capacity	500 pounds (227 kilograms)
Bed Length/Width	90" x 41" (with siderails up) - 37" (with siderails down) 229 cm x 104 cm (with siderails up) - 94 cm (with siderails down)
Bed Height (to top of seat)	19" (Low) - 37" (High) 49 cm (Low) - 95 cm (High) (w/8" Casters)
Mattress Size	Head - 49.5" (126 cm) x 33" (84 cm) x 5" (13 cm), Foot - 31" (79 cm) x 30" (77 cm) x 3" (8 cm), Patient Sleep Surface - 81" (206 cm)
Critical Angles	Maximum Elevation - Head 70°, Trendelenburg 8°
Break-A way Point from Wall	60" (152 cm)
Electrical	Standard 4 motor function: Head-Bed-Foot-Trendelenburg 4 function patient comfort 120 VAC, 60 Hz, 6 Amp - 105 to 135 VAC operating range. Optional: 230 V~, 50/60 Hz, 6 A - 220 to 240 VAC operating range Current leakage less than 100 microamperes. Hospital grade plug and 3-wire heavy duty cord. Compatible with non-flammable anesthetic agents and oxygen by nasal catheter or mask.
Caster Size	8" Standard; 6" Optional

Stryker reserves the right to change specifications without notice.

WARNING / CAUTION / NOTE DEFINITION

The words WARNING, CAUTION and NOTE carry special meanings and should be carefully reviewed.

WARNING

The personal safety of the patient or user may be involved. Disregarding this information could result in injury to the patient or user.

CAUTION

These instructions point out special procedures or precautions that must be followed to avoid damaging the equipment.

NOTE

This provides special information to make maintenance easier or important instructions clearer.

To ensure its proper use and the safety of patients and staff, the Stryker Adel Maternity Bed has been marked with the following caution and warning labels:

DANGER Explosion Hazard - do not use in the presence of flammable anesthetics.

CAUTION This unit is equipped with a hospital grade attachment plug. Grounding reliability can be achieved only when equipment is connected to equivalent receptacle.

CAUTION Electrical shock hazard. Do not remove cover panels. Refer all servicing to qualified personnel.

CAUTION Disconnect power cord before using the back up hand crank. Remove hand crank from back up outlet before connecting power cord.

Bed Symbols



Warning, Refer to Service/Maintenance Manual



Alternating Current



Type B Equipment: equipment providing a particular degree of protection against electric shock, particularly regarding allowable leakage current and reliability of the protective earth connection.

Class 1 Equipment: equipment in which protection against electric shock does not rely on BASIC INSULATION only, but which includes an additional safety precaution in that means are provided for the connection of the EQUIPMENT to the protective earth conductor in the fixed wiring of the installation in such a way that ACCESSIBLE METAL PARTS cannot become live in the event of a failure of the BASIC INSULATION.

Mode of Operation: Continuous

IPX4: Protection from liquid splash



Dangerous Voltage Symbol



Protective Earth Terminal



Potential Equalization Symbol



Medical Equipment Classified by Underwriters Laboratories Inc. with Respect to Electric Shock, Fire, Mechanical and Other Specified Hazards Only in Accordance with UL 2601-1 and CAN/CSA C22.2 No. 601.1

Introduction

SAFETY TIPS AND GUIDELINES

Before operating the Stryker Adel Maternity Bed, it is important to read and understand all information in this manual. Carefully read and strictly follow the safety guidelines listed on this page.

It is important that all users have been trained and educated on the inherent hazards associated with the usage of electric beds.

WARNING

- The Stryker Adel Maternity Bed is equipped with a hospital grade plug for protection against shock hazard. It must be plugged directly into a properly grounded three-prong receptacle. Grounding reliability can be achieved only when a hospital grade receptacle is used.
 - Powered bed mechanisms can cause serious injury. Operate bed only when all persons are clear of the mechanisms.
 - To help reduce the number and severity of falls by patients, always leave the bed in the lowest position when the patient is unattended.
 - Leave the siderails fully up and locked when the patient is unattended. When raising the siderails, listen for the "click" that indicates the siderail has locked into the up position. Pull firmly on the siderail to ensure it is locked into position. Siderails are not intended to be a patient restraint device. It is the responsibility of the attending medical personnel to determine the degree of restraint necessary to ensure a patient will remain safely in bed.
 - Always apply the caster brakes when a patient is getting on or off the bed. Always keep the caster brakes applied when a patient is on the bed (except during transport). Serious injury could result if the bed moves while a patient is getting in or out of bed. After the brake pedal is applied, push on the bed to ensure the brakes are locked. When moving the bed, toggle the steer pedal to put the bed in the steer mode. This locks the swivel motion of the right foot end caster and makes the bed easier to move.
 - The instant CPR release is for emergency use only. When activating the instant CPR, all persons and equipment must be removed from the area below and around the Fowler (back rest) section of the bed or serious personal injury or damage to the equipment could occur.
 - When large spills occur in the area of the circuit boards, 110 volt cables and motors, immediately unplug the bed power cord from the wall socket. Remove the patient from the bed and clean up the fluid. Have maintenance completely check the bed. Fluids can have an affect on operational capabilities of any electrical product. DO NOT put the bed back into service until it is completely dry and has been thoroughly tested for safe operation.
 - Do not steam clean or hose off the bed. Do not immerse any part of the bed. The internal electric parts may be damaged by exposure to water. Hand wash all surfaces of the bed with warm water and mild detergent. Dry thoroughly. Inspect the mattress cover after each use. Discontinue use if any cracks or rips are found in the cover which may allow fluids to enter the mattress. Exposure to fluids may cause injury to patient and/or user.
 - Preventative maintenance should be performed at a minimum of annually to ensure all bed features are functioning as designed. Close attention should be given to safety features including, but not limited to:
 - Safety side latching mechanisms,
 - Frayed electrical cords and components,
 - All electrical controls return to off or neutral position when released,
 - Caster braking system,
 - No controls or cabling entangled in bed mechanisms,
 - Leakage current 100 MA max.
 - For additional maintenance information, refer to your maintenance manual.
 - Always unplug bed during service or cleaning. When working under the bed with the bed in the high position, always place blocks under the litter frame and set the brakes to prevent injury in case the Bed Down switch is accidentally pressed.
 - Unplug the bed power cord from the wall socket before using the hand crank. Remove the hand crank before plugging the power cord into the wall socket or personal injury could result.
-

Unpacking and Initial Set-Up Procedures

UNPACKING INSTRUCTIONS

Refer to unpacking instructions attached to the bed inside the crate.

SET-UP PROCEDURES

It is important that the Stryker Adel Maternity Bed is working properly before it is put into service. The following list will help ensure that each part of the bed is tested.

- Plug the bed into a properly grounded, hospital grade wall receptacle.

WARNING

The Stryker Adel Maternity Bed is equipped with a hospital grade plug for protection against shock hazard. It must be plugged directly into a properly grounded three-prong receptacle. Grounding reliability can be achieved only when a hospital grade receptacle is used.

-
- Ensure the siderails raise and lower smoothly and lock in the up position.
 - Ensure that the brakes hold when the brake pedal is engaged.
 - Test each function on the (optional) hand pendant to ensure that each function is working properly.

Beds equipped with nurse communication siderail control option only:

- Plug the interface cable into the 37 pin connector in the litter frame at the head end of the bed, and into the "Patient Station", "Head Wall", "Dock Station", or equivalent (whichever applies).
- Run through each function on the siderail control panels to ensure that each function is working properly.

NOTE

To prevent a low battery condition when the bed is not plugged in, position the cord out switch at the head end of the bed to the off position. The switch is identified by the label shown below. If the switch is not positioned as shown below and the bed power cord and pendant cord are unplugged, the life of the back-up battery will be significantly reduced.

If the siderail lights LED (located on the outside of both siderails) is flashing, the Nurse Call battery needs to be replaced. The battery is located on the patient's right side at the head end of the bed. No tools are required to replace the battery. Unplug the bed power cord from the wall socket and replace the battery. After replacing the battery, verify the siderail lights LED is no longer flashing and operates normally when the different light settings are selected.

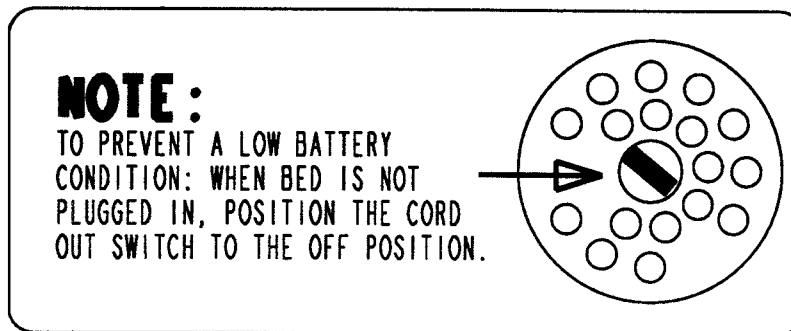

Bed Illustration

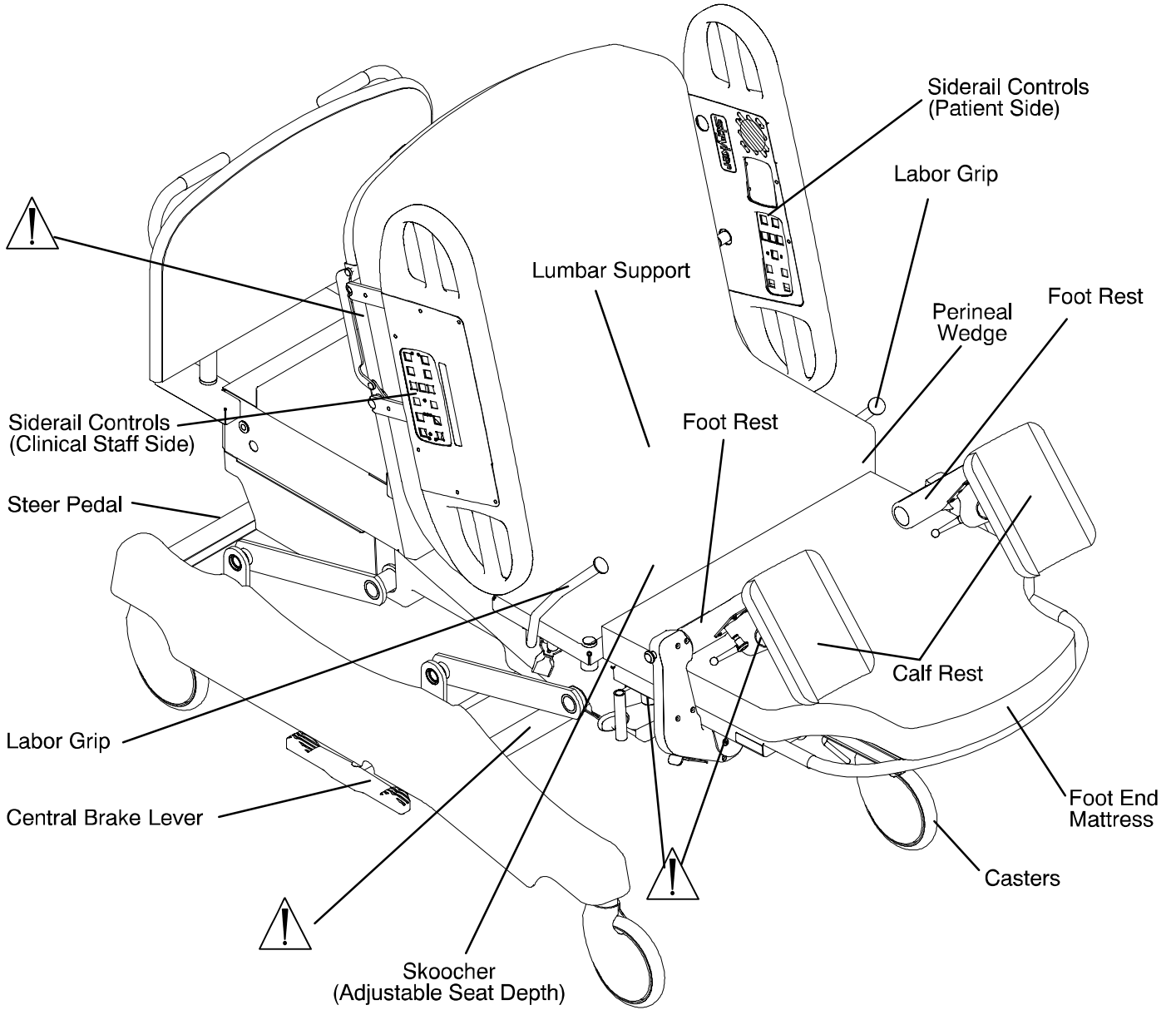

WARNING

Potential pinch points

Siderail Operation Guide

OPERATING SIDERAILS

To engage the head end siderail, grasp the rail and swing it upward to full height. When the siderail is being raised, it does not lock in the intermediate position. To lower the siderail, push in the release handle and rotate the siderail until it locks in the intermediate position. To lower the siderail fully, push in the release handle again and rotate the siderail until it is completely lowered.

NOTE

To activate the siderail bypass mechanism, the rail must be fully lowered. If the rail is not completely lowered, the siderail will lock in the intermediate position when it is raised.

USING THE SIDERAIL CONTROL PANEL LIGHTS

The bed is equipped with lights to illuminate the head end siderail control panels and the red nurse call switches. Four settings are available for the control panel lights. Push once to turn on the lights at low intensity, again to change to high intensity, a third time to leave just the nurse call light on, and a fourth time to turn all lights off.

INSIDE SIDERAIL FUNCTION GUIDE

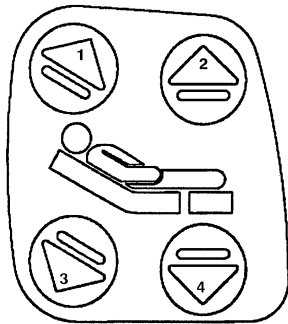

1. Push to raise Fowler (back rest).

2. Push to raise foot section.

3. Push to lower Fowler (back rest).

4. Push to lower foot section.

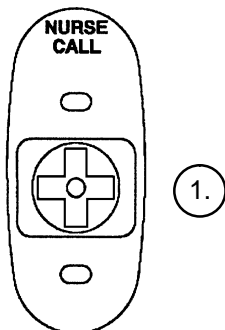

1. Push to activate Nurse Call

NOTE

Yellow LED will light when button is pushed. Red LED will light with Nurse Station acknowledgement.

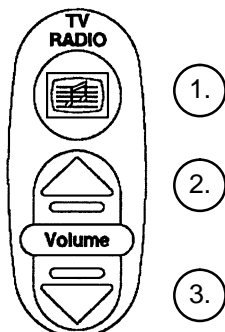

1. Push to turn TV or radio on and to select a channel.

2. Push to increase volume.

3. Push to decrease volume.

Siderail Operation Guide

INSIDE SIDERAIL FUNCTION GUIDE (CONTINUED)

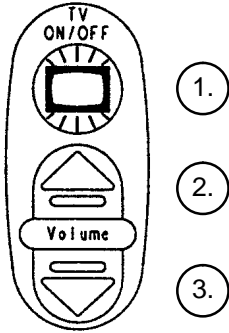

1. Push to turn the television on and to select a channel.
2. Push to increase the television volume.
3. Push to decrease the television volume.

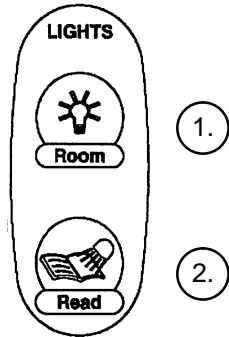

1. Push to turn the room light on.
Push again to turn off.
2. Push to turn the bed overhead light on.
Push again to turn off.

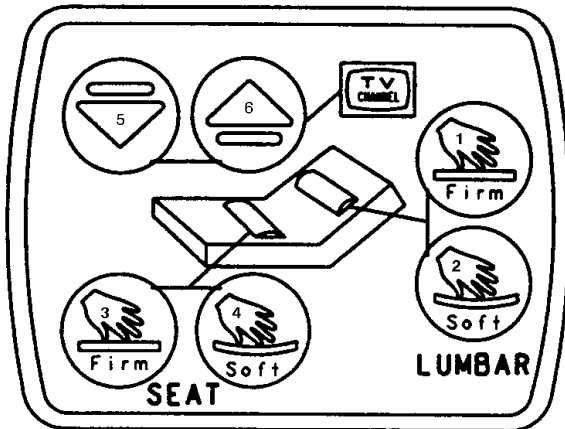

1. Push for more support to the patient's lower back.
2. Push for less support to the patient's lower back.
3. Push for more support to the patient's seat section.
4. Push for less support to the patient's seat section.
5. Push to change the channel on the television.
6. Push to change the channel on the television.

Siderail Operation Guide

OUTSIDE SIDERAIL FUNCTION GUIDE

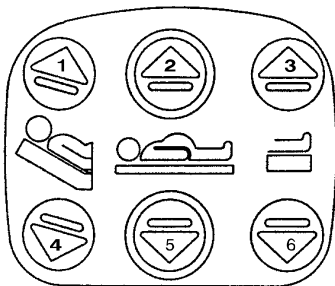

1. Push to raise Fowler (back rest).
2. Push to raise bed height.
3. Push to raise foot section.
4. Push to lower Fowler (back rest).
5. Push to lower bed height.
6. Push to lower foot section.

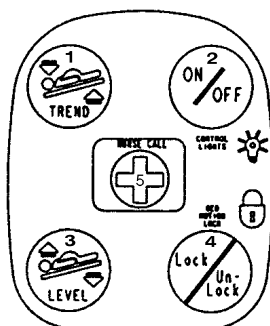

1. Push to lower head end of bed (Trendelenburg position). (This function is also used for pelvic tilt).
2. Push to toggle siderail lights to different settings:
 - A. LOW
 - B. HIGH
 - C. NURSE CALL ONLY
 - D. OFF
3. Push to raise head end of bed and/or return bed to level.
4. Push to lock out all bed motion. Push again to unlock. (LED will light when bed motion is locked.)
5. Push to activate Nurse Call.

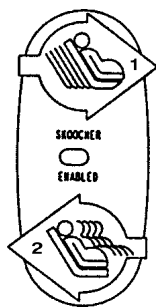

1. Push to decrease seat depth.
2. Push to increase seat depth.

NOTE: The Fowler (back rest) must be raised until the “ENABLED” LED lights (a minimum of 35°) before the depth can be changed.

Communication Pendant Operation Guide

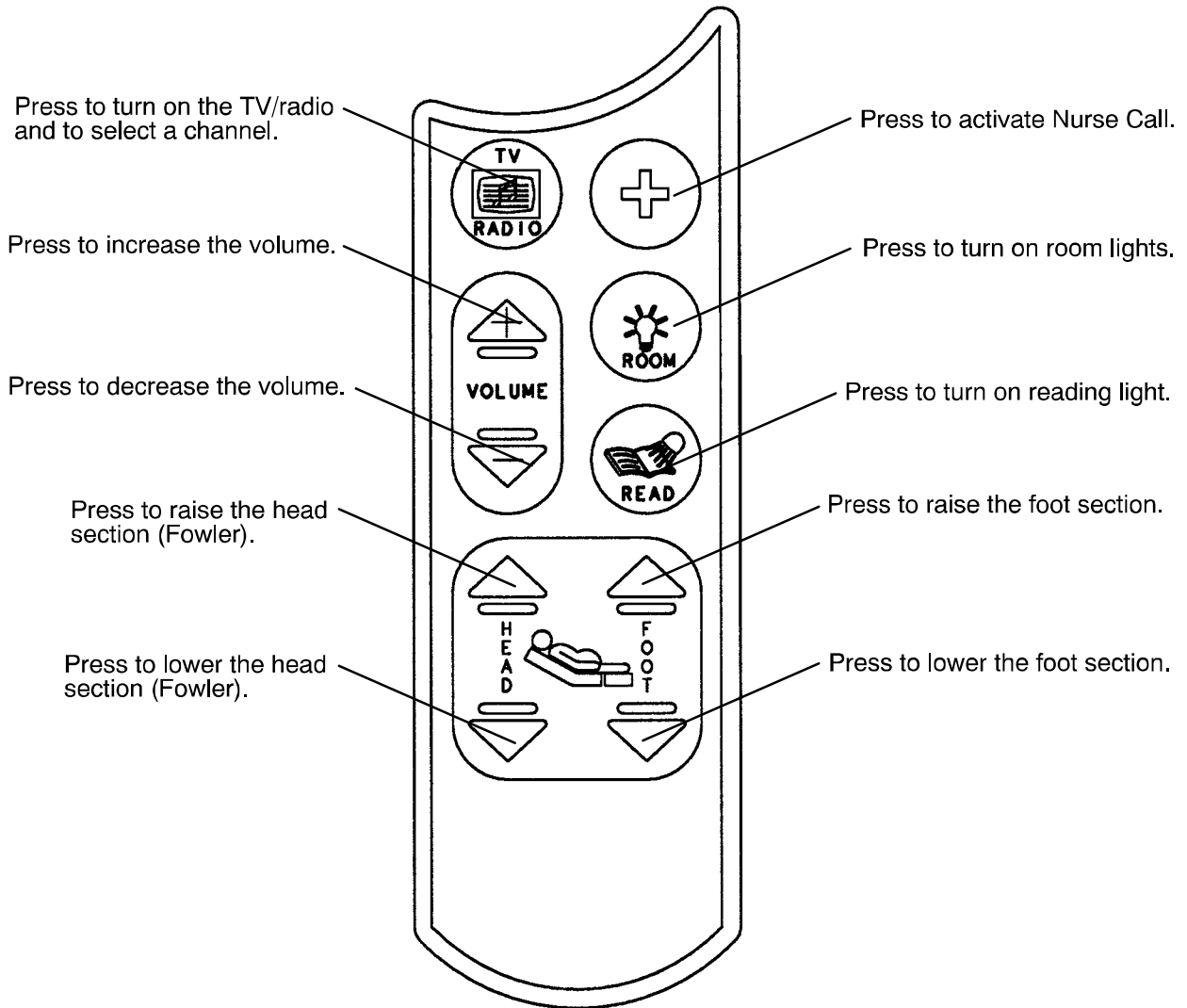

Motion Pendant Operation Guide

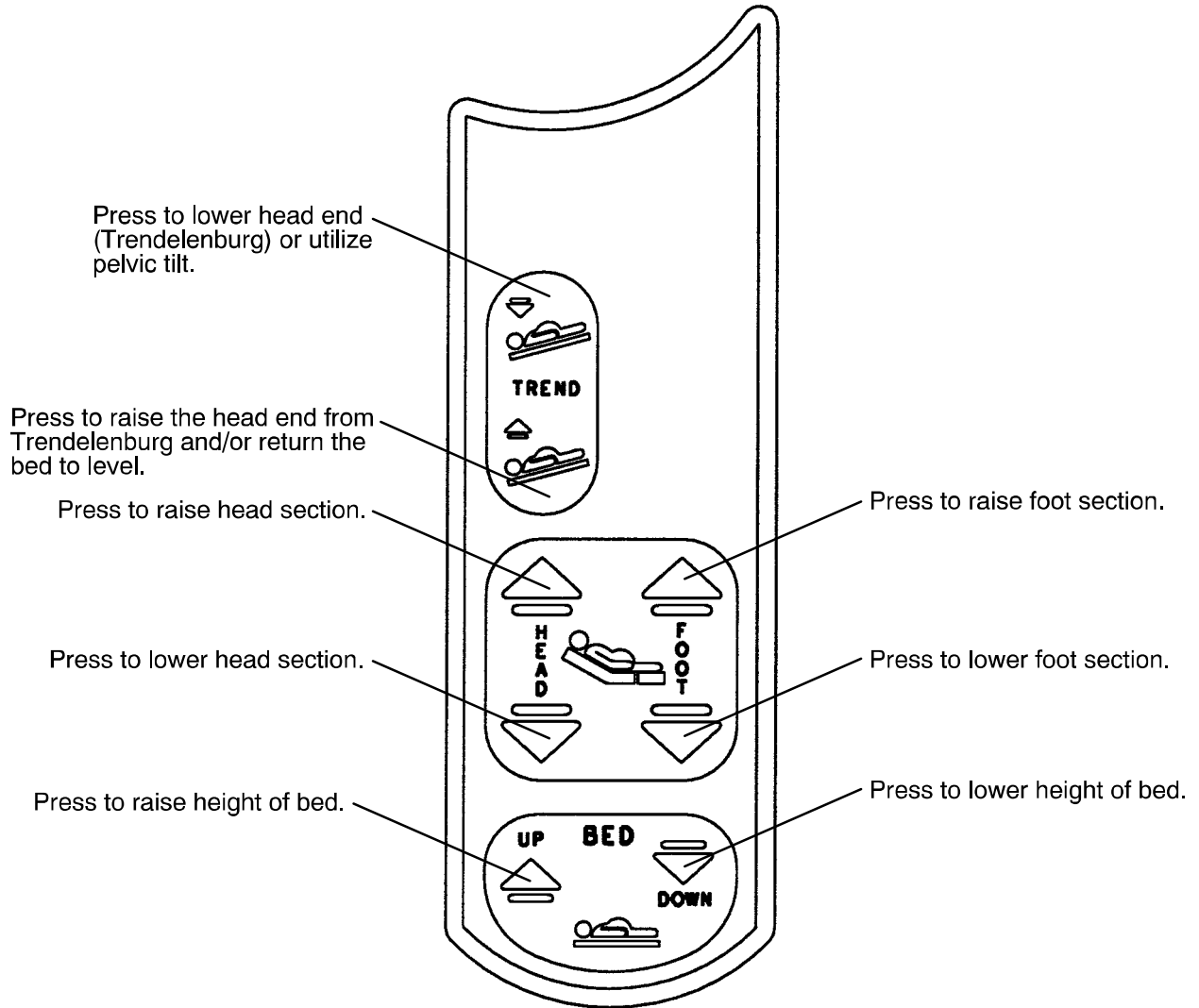

Motion Pendant with Nurse Call Operation Guide

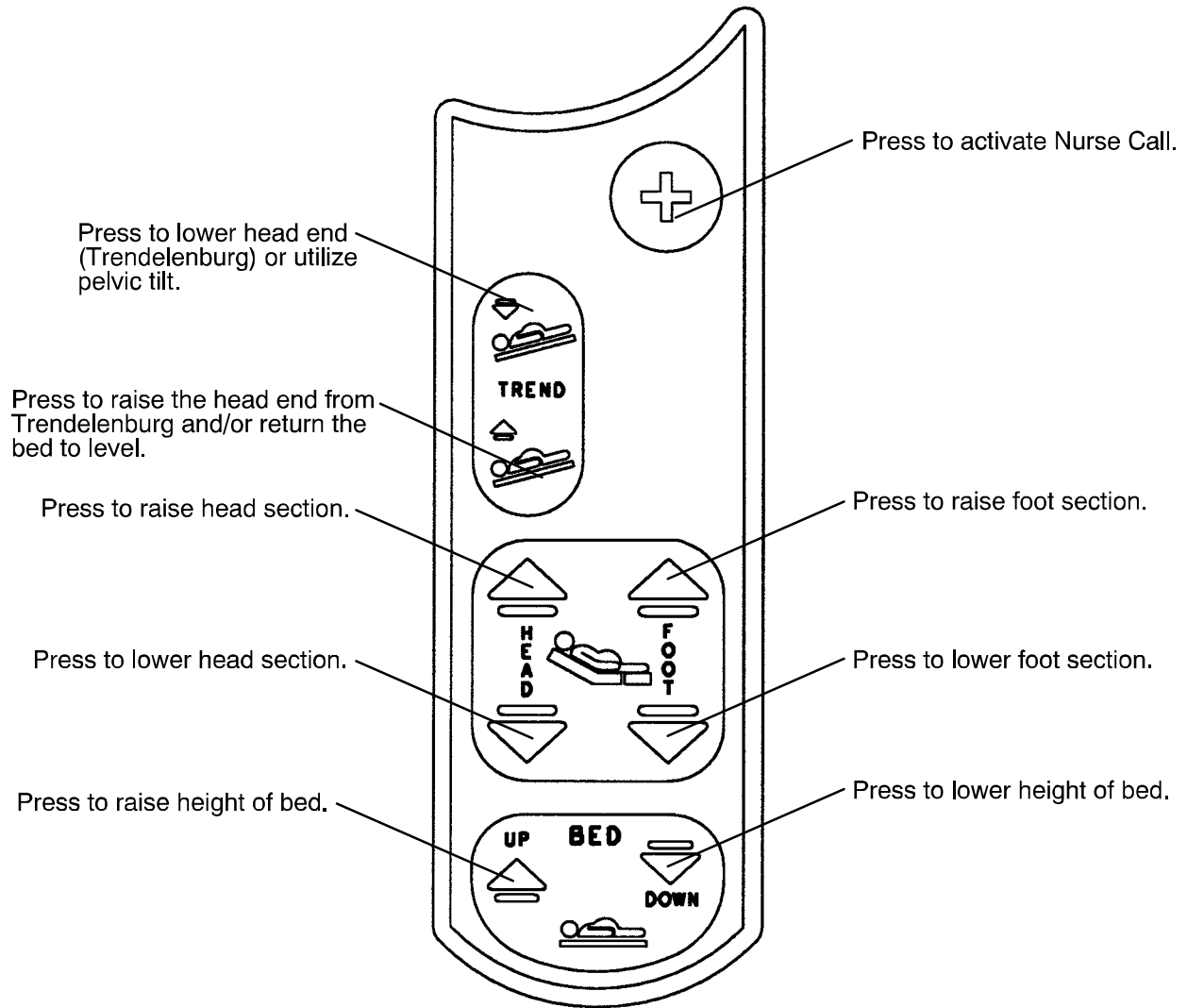

Operating Bed Features

USING THE BRAKE AND STEER PEDALS

The brake pedals are located at the center of the base frame on both sides of the bed. To engage the brakes, depress the pedal to the brake position. To disengage the brakes, depress the pedal to the neutral position. The steer pedal is located at the head end of the bed. To engage the steering function, depress the pedal to the ON position. To disengage the steering function, depress the pedal to the OFF position.

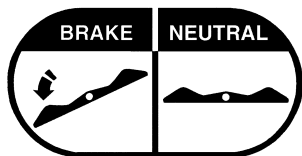

BRAKE PEDAL



STEER PEDAL

USING THE MANUAL MOTOR CRANK

WARNING

To avoid serious personal injury or damage to the equipment, unplug the bed power cord from the wall receptacle before using the hand crank and remove the hand crank from the motor before plugging in the power cord.

If there is a loss of electrical power to the bed, there is a manual motor crank stored in clips on the head end of the bed. Center the notch in the end of the crank on the roll pin on the bed motor assembly or the Fowler motor assembly and crank the bed to the desired position.

ACTIVATING INSTANT CPR

The CPR release lever is located at the head section on both sides of the bed. To activate the CPR release, grasp the lever and squeeze tightly. The Fowler (back rest) will lower to the lowest position instantly.

WARNING

The instant CPR release is for emergency use only. Before activating the instant CPR, verify all persons and equipment are away from the area below and around the Fowler (back rest) section of the bed or serious personal injury or damage to the equipment could occur.

LOCKING OUT THE SIDERAIL CONTROLS

The lock out feature disables the siderail bed motion controls. Lock out buttons are located on the outside of both siderails. Lock out the bed motion controls by depressing the button once. The bed motion lockout LED will light. Reactivate the controls by pressing the button again.

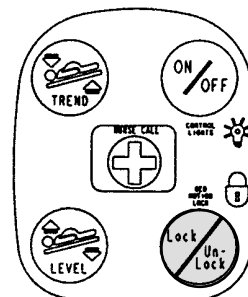

Operating Bed Features

REMOVING THE HEAD BOARD



To remove the head board, lift it straight up and off the bed. To replace the head board, align the plastic inserts on the bottom of the head board with the pins on the bed and lower the head board until it completely engages the pins.

USING THE LABOR GRIPS

To position the labor grips, grasp the handle and pull the grip out and up above the mattress until the mechanism locks into position. To lower the grips, pull the lever to release the grip and, as it begins to rotate, release the lever and lower the grip to the stored position.

ADJUSTABLE SEAT DEPTH (OPTIONAL)

To accommodate patients of different sizes, the depth of the seat can be adjusted up to 4 inches (from 12.5 to 8.5 inches).

- The Fowler (back rest) must be raised to a minimum of 35° before the seat depth can be changed. Once the Fowler (back rest) is elevated to 35°, the “ENABLED” LED on the outside of the siderail will light and the seat depth can be changed. When the Fowler (back rest) is lowered (either electrically or using the emergency CPR release), the bed will automatically adjust the seat depth to 12.5”.
- To reduce seat depth, depress the  button on the siderail or the hand pendant to move the Fowler (back rest) toward the foot end of the bed. Release the button when the desired seat depth is attained.
- To increase seat depth, press the  button to move the Fowler (back rest) toward the head end of the bed.

NURSE CALL BATTERY

To prevent a low battery condition when the bed is not plugged in, position the cord out switch at the head end of the bed to the off position. The switch is identified by the label shown below. If the switch is not positioned as shown below and the bed power cord and pendant cord are unplugged, the life of the back-up battery will be significantly reduced.

If the siderail lights LED (located on the outside of both siderails) is flashing, the Nurse Call battery needs to be replaced. The battery is located on the patient’s right side at the head end of the bed. No tools are required to replace the battery. Unplug the bed power cord from the wall socket and replace the battery. After replacing the battery, verify the siderail lights LED is no longer flashing and operates normally when the different light settings are selected.

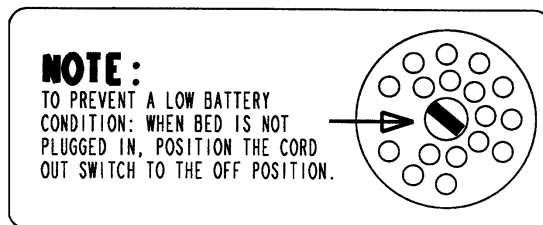

Operating Bed Features

NIGHT LIGHT USAGE

The bed is equipped with a night light to illuminate the floor area around the bed. There is a switch on the light to turn it on and off.

OPERATING THE GLIDEAWAY FOOT SECTION/ATTACHABLE CALF SUPPORTS

- Rotate the foot rest into position by pulling it out and up over the foot end mattress until it clicks into place. Ensure the foot rest is securely locked in the upright position by grasping and attempting to move it.
- After they are in position, the foot rests are adjustable six ways:
 1. Abduct/Adduct (pivoting)
Pivoting in and out allows the clinician to position the patient's feet and legs at the desired width. Pull down on the knob located below the foot mattress. Pivot the foot rest into the desired position and release the knob to lock the foot rest into place.
 2. In/Out
The in/out motion allows patients of different heights to be accommodated comfortably. Pull the lever marked with the PULL label to increase the distance of the foot rest from the Perineal edge. Release the lever when the foot rest is in the desired position.
 3. Height
The foot end high/low adjustment allows the foot end of the bed to be positioned 1" above or 5" below the top of the seat mattress to accommodate different sized patients when the foot rest, calf supports, or labor bar are being used.
- To store the foot rests, loosen the ball screws on the self-storing calf supports (if used). Ensure the foot rests are pointing toward the end of the bed. Pull the lever marked "PULL" located at the bottom of the foot rest support and the foot rest will glide under the foot mattress.

REMOVING THE FOOT SECTION MATTRESS

Before removing the foot mattress, put the foot rests into position above the foot mattress. Place the patient's feet in the contoured foot rests. To remove the foot mattress, pull up on the red release handle on either side of the mattress and slide the mattress straight off the bed.

NOTE

If the foot section mattress is placed with the perineal edge toward the floor, it will stand independently.

To reinstall the foot section of the bed, set the foot mattress back on the bed and slide it straight in until it locks into place. Pull on the handles to ensure it is securely installed.

Operating Bed Features

OPERATING THE OPTIONAL SINGLE-STEP FOOT SECTION

REMOVING THE FOOT SECTION MATTRESS

- To remove the foot mattress section, grasp the handle on the front of the mattress assembly and push the mattress forward so it disengages from the brackets.
- Slowly lift the mattress assembly away from the bed, positioning the patient's feet in the foot pans.
- To reinstall the foot section on the bed, set the foot mattress back on the bed and slide the mattress in. The foot mattress will lock into place. Pull on the mattress to ensure it is installed correctly.

FOOT SECTION OPERATION

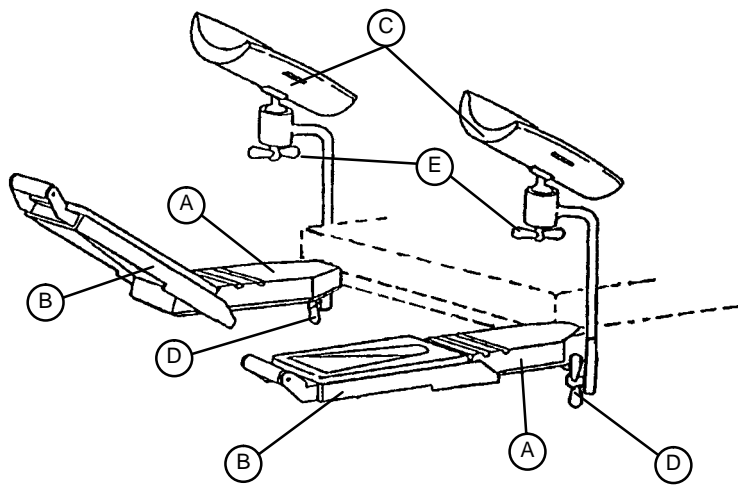

1. To position the foot pan section (A), pull the knob under the pan, grasp the foot rest section (B) and rotate outward. There are holes in the foot pan to lock the pan into various positions.
2. To position the foot rest section (B), lift upward by the front push bar and slide the foot rest along the slotted section of the foot pan. Lower the foot rest so it engages in the desired slot on the foot pan. Once the patient is positioned, the foot rests and pans can be adjusted for maximum access and for patient comfort.
3. To use the calf supports (C) instead of the foot pans, insert the supports into the receptacles and tighten the knobs (D) to hold them securely in place. To position the calf supports, loosen knob (E) and rotate the support to the desired angle. Tighten the knob to hold the rest in place.

OPTIONAL LUMBAR PILLOW AND PERINEAL WEDGE

- Use the one-touch lumbar and seat buttons on the siderail to adjust the amount of support given to the patient's lumbar and seat areas if the bed is equipped with this option.

NOTE

Be sure the locating pins on the underside of the mattress are inserted in the holes in the steel seat support.

Patient Positioning

BIRTHING BED POSITIONING

- Position the patient's feet in the foot rests.
- Raise or lower the foot rests to a position comfortable for the patient.
- Remove the foot section and tuck the drape into the drainage pan.
- Raise the bed to a comfortable height by pressing the "Bed-Up" control on the siderail and position the patient's perineum out and over the edge of the seat section.

DELIVERY TABLE POSITIONING

- Slide the patient down to the perineal edge.
- Lower the foot section to its lowest position.
- Position the attached calf supports and place the patient's legs in the supports.

TRENDELENBURG POSITIONING

Lower the Fowler (back rest) by pressing the control on the siderail or by squeezing the CPR lever. Press the Trendelenburg button on the siderail or the control pendant to lower the head end of the bed to the desired angle.

PELVIC TILT

Use the Trendelenburg button on the siderail or the control pendant to provide more pelvic tilt and comfort for the patient when the Fowler (back rest) is raised.

Using Optional Accessories

USING LEG SUPPORTS

To use full-length leg supports on the bed, insert the leg support bar into the receptacle near the labor grips at the perineal edge.

USING THE LABOR BAR

To use the labor bar, insert it into the holes on each side of the seat section, under the mattress at the perineal edge. The labor bar can be used by the patient to aid with various birthing positions such as squatting or kneeling.

USING THE ARM BOARD

The arm board is held in place between the mattress and the frame. The arm board is provided with a removable mattress. The weight of the patient retains the arm board in the desired position.

Using Optional Accessories

OPERATING OPTIONAL 3-STAGE PERMANENTLY ATTACHED I.V. POLE

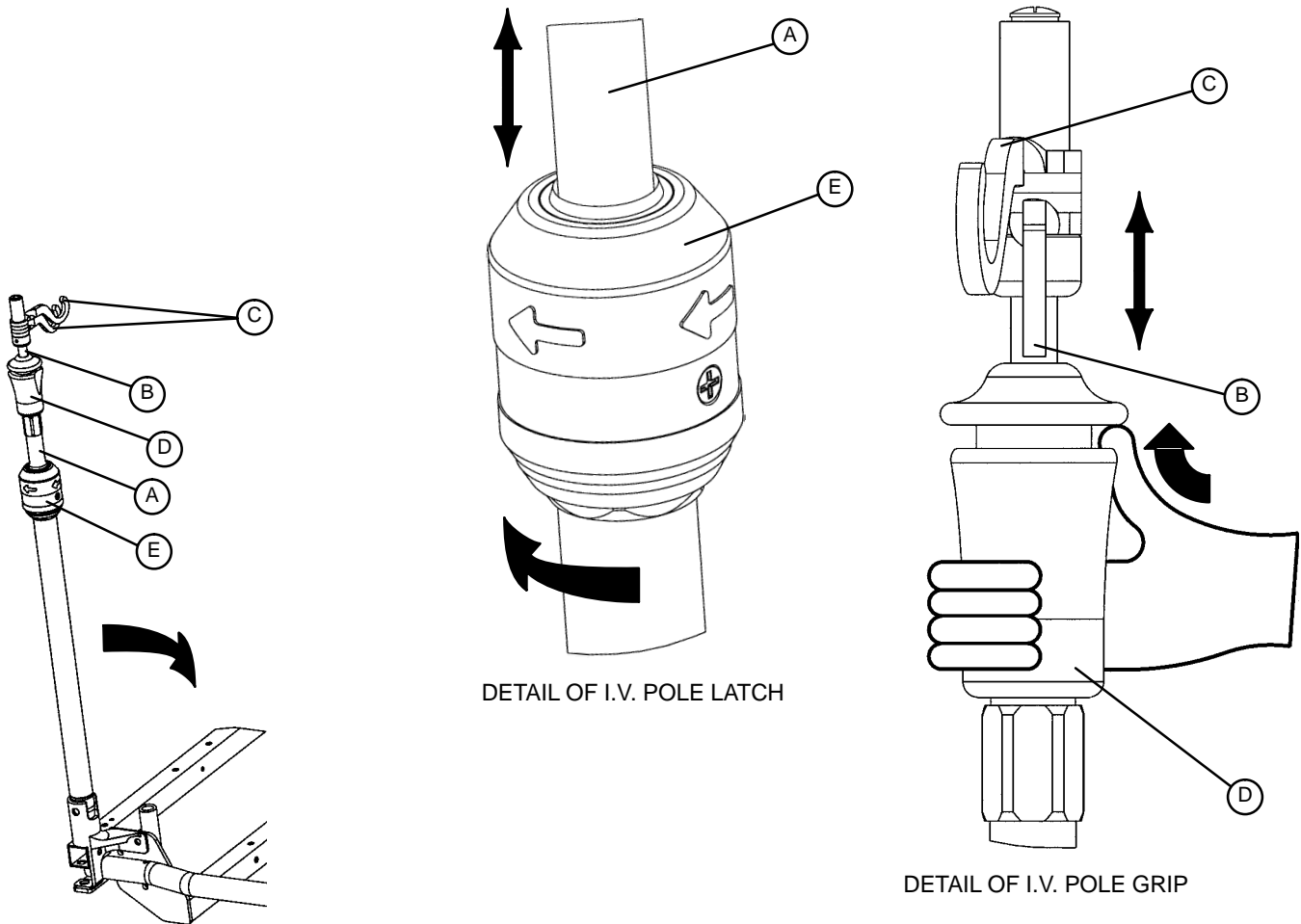

NOTE

The 3-stage permanently attached I.V. pole is an option and can only be installed at the head end of the bed.

To use the 3-stage permanently attached I.V. pole:

1. Lift and pivot the pole from the storage position and push down until it is locked into the receptacle.
2. To raise the height of the pole, pull up on the telescoping portion (A) until it locks into place at its fully raised position.
3. For a higher I.V. pole, pull up on section (B). Release section (B) at any desired height and it will lock into place.
4. Rotate the I.V. hangers (C) to the desired position and hang the I.V. bags.
5. To lower the I.V. pole, push up on the red portion of grip (D) while holding onto section (B) until it lowers. Turn latch (E) clockwise until section (A) lowers.

CAUTION

To avoid damage, the weight of the I.V. bags should not exceed 40 pounds.

To avoid damage while transporting the bed, verify the I.V. pole is at a low enough height to allow it to pass safely through door openings.

Cleaning

WARNING

Hand wash all surfaces of the bed with warm water and mild detergent. Dry thoroughly. **DO NOT STEAM CLEAN, PRESSURE WASH, HOSE OFF OR ULTRASONICALLY CLEAN.** Using these methods of cleaning is **not** recommended and may void this product's warranty.

Inspect the mattress cover after each use. Discontinue use if any cracks or rips are found in the cover which may allow fluids to enter the mattress. Exposure to fluids may cause injury to patient and/or user.

In general, when used in those concentrations recommended by the manufacturer, either phenolic type or quaternary type disinfectants can be used. Iodophor type disinfectants are not recommended for use because staining may result. The following products have been tested and have been found not to have a harmful effect **WHEN USED IN ACCORDANCE WITH MANUFACTURERS RECOMMENDED DILUTION.***

TRADE NAME	DISINFECTANT TYPE	MANUFACTURER	*MANUFACTURER'S RECOMMENDED DILUTION
A33	Quaternary	Airwick (Professional Products Division)	2 ounces/gallon
A33 (dry)	Quaternary	Airwick (Professional Products Division)	1/2 ounce/gallon
Beaucoup	Phenolic	Huntington Laboratories	1 ounce/gallon
Blue Chip	Quaternary	S.C. Johnson	2 ounces/gallon
Elimstaph	Quaternary	Walter G. Legge	1 ounce/gallon
Franklin Phenomysan F2500	Phenolic	Purex Corporation	1 1/4 ounce/gallon
Franklin Sentinel	Quaternary	Purex Corporation	2 ounces/gallon
Galahad	Phenolic	Puritan Churchill Chemical Company	1 ounce/gallon
Hi-Tor	Quaternary	Huntington Laboratories	1/2 ounce/gallon
LPH	Phenolic	Vestal Laboratories	1/2 ounce/gallon
Matar	Phenolic	Huntington Laboratories	1/2 ounce/gallon
Omega	Quaternary	Airwick (Professional Products Division)	1/2 ounce/gallon
Quanto	Quaternary	Huntington Laboratories	1 ounce/gallon
Sanikleen	Quaternary	West Chemical Products	2 ounces/ gallon
Sanimaster II	Quaternary	Service Master	1 ounce/gallon
Vesphene	Phenolic	Vestal Laboratories	1 1/4 ounce/gallon
Wexcide	Phenolic	Wexford Labs	1/2 ounce/gallon

Quaternary Germicidal Disinfectants, used as directed, and/or Chlorine Bleach products, typically 5.25% Sodium Hypochlorite in **dilutions ranging between 1 part bleach to 100 parts water, and 2 parts bleach to 100 parts water are not considered mild detergents. These products are corrosive in nature and may cause damage to your stretcher if used improperly.** If these types of products are used to clean Stryker patient handling equipment, measures must be taken to insure the stretchers are rinsed with clean water and thoroughly dried following cleaning. Failure to properly rinse and dry the stretchers will leave a corrosive residue on the surface of the stretcher, possibly causing premature corrosion of critical components.

NOTE

Failure to follow the above directions when using these types of cleaners may void this product's warranty.

REMOVAL OF IODINE COMPOUNDS

This solution may be used to remove iodine stains from mattress cover and foam footrest pad surfaces.

1. Use a solution of 1-2 tablespoons Sodium Thiosulfate in a pint of warm water to clean the stained area. Clean as soon as possible after staining occurs. If stains are not immediately removed, allow solution to soak or stand on the surface.
2. Rinse surfaces which have been exposed to the solution in clear water before returning bed to service.

Preventative Maintenance Checklist

- _____ All fasteners secure
- _____ All welds intact, not cracked or broken
- _____ No bent or broken tubing or sheet metal
- _____ No debris in casters
- _____ All casters secure and swivel properly
- _____ Engage brake pedal and push on the bed to ensure all casters lock securely
- _____ Steer caster latches properly
- _____ Siderails move and latch properly
- _____ Fowler operates properly
- _____ Fowler (back rest) Slide operates properly
- _____ Bed Up/Down operates properly
- _____ Foot operates properly
- _____ Trendelenburg operates properly
- _____ I.V. pole intact and operating properly
- _____ No rips or cracks in mattress cover
- _____ Lubricate where required
- _____ Replace Nurse Call 9V battery (annually)
- _____ Power cord not frayed
- _____ No cables worn or pinched
- _____ All electrical connections tight
- _____ All grounds secure to the frame
- _____ Ground impedance not more than 100 milliohms
- _____ Current leakage not more than 100 microamps

Serial No. _____

NOTE

Preventative maintenance should be performed at a minimum of annually. A preventative maintenance program should be established for all Stryker Medical equipment. Preventative maintenance may need to be performed more frequently based on the usage level of the product.

Warranty

Limited Warranty:

Stryker Medical Division, a division of Stryker Corporation, warrants to the original purchaser that its products should be free from defects in material and workmanship for a period of one (1) year after date of delivery. Stryker's obligation under this warranty is expressly limited to supplying replacement parts and labor for, or replacing, at its option, any product which is, in the sole discretion of Stryker, found to be defective. Stryker warrants to the original purchaser that the frame and welds on its beds will be free from structural defects for as long as the original purchaser owns the bed. If requested by Stryker, products or parts for which a warranty claim is made shall be returned prepaid to Stryker's factory. Any improper use or any alteration or repair by others in such manner as in Stryker's judgement affects the product materially and adversely shall void this warranty. Any repair of Stryker products using parts not provided or authorized by Stryker shall void this warranty. No employee or representative of Stryker is authorized to change this warranty in any way.

Stryker Medical beds are designed for a 15 year expected life under normal use conditions and appropriate periodic maintenance as described in the maintenance manual for each device.

This statement constitutes Stryker's entire warranty with respect to the aforesaid equipment. STRYKER MAKES NO OTHER WARRANTY OR REPRESENTATION, EITHER EXPRESSED OR IMPLIED, EXCEPT AS SET FORTH HEREIN. THERE IS NO WARRANTY OF MERCHANTABILITY AND THERE ARE NO WARRANTIES OF FITNESS FOR ANY PARTICULAR PURPOSE. IN NO EVENT SHALL STRYKER BE LIABLE HEREUNDER FOR INCIDENTAL OR CONSEQUENTIAL DAMAGES ARISING FROM OR IN ANY MANNER RELATED TO SALES OR USE OF ANY SUCH EQUIPMENT.

To Obtain Parts and Service:

Stryker products are supported by a nationwide network of dedicated Stryker Field Service Representatives. These representatives are factory trained, available locally, and carry a substantial spare parts inventory to minimize repair time. Simply call your local representative, or call Stryker Customer Service at (800) 327-0770.

Service Contract Coverage:

Stryker has developed a comprehensive program of service contract options designed to keep your equipment operating at peak performance at the same time it eliminates unexpected costs. We recommend that these programs be activated *before* the expiration of the new product warranty to eliminate the potential of additional equipment upgrade charges.

A SERVICE CONTRACT HELPS TO:

- Ensure equipment reliability
- Stabilize maintenance budgets
- Diminish downtime
- Establish documentation for JCAHO
- Increase product life
- Enhance trade-in value
- Address risk management and safety

Warranty

Stryker offers the following service contract programs:

SPECIFICATIONS	GOLD	SILVER	PM* ONLY
Annually scheduled preventative maintenance	X		X
All parts,** labor, and travel	X	X	
Unlimited emergency service calls	X	X	
Priority one contact; two hour phone response	X	X	X
Most repairs will be completed within 3 business days	X	X	
JCAHO documentation	X	X	X
On-site log book w/ preventative maintenance & emergency service records	X		
Factory-trained Stryker Service Technicians	X	X	X
Stryker authorized parts	X	X	X
End of year summary	X		
Stryker will perform all service during regular business hours (9-5)	X	X	X

* Replacement parts and labor for products under PM contract will be discounted.

** Does not include any disposable items, I.V. poles (except for Stryker HD permanent poles), mattresses, or damage resulting from abuse.

Stryker Medical also offers *personalized* service contracts.

Pricing is determined by age, location, model and condition of product.

For more information on our service contracts, please call your local representative or call (800) 327-0770 (option #2).

Return Authorization:

Merchandise cannot be returned without approval from the Stryker Customer Service Department. An authorization number will be provided which must be printed on the returned merchandise. Stryker reserves the right to charge shipping and restocking fees on returned items.

SPECIAL, MODIFIED, OR DISCONTINUED ITEMS NOT SUBJECT TO RETURN.

Damaged Merchandise:

ICC Regulations require that claims for damaged merchandise must be made with the carrier within fifteen (15) days of receipt of merchandise. **DO NOT ACCEPT DAMAGED SHIPMENTS UNLESS SUCH DAMAGE IS NOTED ON THE DELIVERY RECEIPT AT THE TIME OF RECEIPT.** Upon prompt notification, Stryker will file a freight claim with the appropriate carrier for damages incurred. Claim will be limited in amount to the actual replacement cost. In the event that this information is not received by Stryker within the fifteen (15) day period following the delivery of the merchandise, or the damage was not noted on the delivery receipt at the time of receipt, the customer will be responsible for payment of the original invoice in full.

Claims for any short shipment must be made within thirty (30) days of invoice.

International Warranty Clause:

This warranty reflects U.S. domestic policy. Warranty outside the U.S. may vary by country. Please contact your local Stryker Medical representative for additional information.



European Representative

Stryker EMEA RA/QA Director
Stryker France
ZAC Satolas Green Pusignan
Av. De Satolas Green
69881 MEYZIEU Cedex
France

stryker[®]
Medical

6300 S. Sprinkle Road, Kalamazoo, MI 49001-9799

(800) 327-0770
www.strykermedical.com



DH 10/03 4700-090-019 REV D