

















ProCuity™ Bed Series

Operations Manual

REF	300900000000
REF	3009PX-L-100
REF	3009PX-L-200
REF	3009PX-LE-400
REF	3009PX-LE-450
REF	3009PX-LE-500
REF	3009PX-LEX-400
REF	3009PX-LEX-450
REF	3009PX-LEX-500
REF	3009PX-Z-400
REF	3009PX-Z-450
REF	3009PX-Z-500
REF	3009PX-ZX-400
REF	3009PX-ZX-450
REF	3009PX-ZX-500
REF	3009PX-ZM-400
REF	3009PX-ZM-450
REF	3009PX-ZM-500
REF	3009PX-ZM-600
REF	3009PX-ZMX-400
REF	3009PX-ZMX-450
REF	3009PX-ZMX-500
REF	3009PX-ZMX-600



Symbols

	Refer to instruction manual/booklet
	Consult instructions for use
	General warning
	Caution
	Warning; electricity
	Fuse rating
	Non-ionizing radiation
	Warning; crushing of hands
	China RoHS with declarable substances
	Catalogue number
	Serial number
	European medical device
	CE mark
	UK Conformity Assessment mark
	Importer
	Unique device identifier















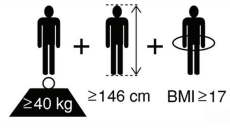

	Authorized representative in the European Community
	Authorized representative in Switzerland
	For US Patents see www.stryker.com/patents
	Manufacturer
	Date of manufacture
	Safe working load
	Mass of equipment
	NAWI Class III
	Maximum patient weight
	Adult patient
	Alternating current
	Direct current
	Duty cycle of product
	Unit provides terminal for connection of a potential equalization conductor. The potential equalization conductor provides direct connection between the unit and potential equalization busbar of the electrical installation.
	Protective earth ground
IPX4	Protection from liquid splash
	Type B applied part
	Medical Equipment Classified by Underwriters Laboratories Inc. With Respect to Electric Shock, Fire, and Mechanical Hazards Only in Accordance with ANSI/AAMI ES60601-1:2005/(R)2012 and A1:2012 C1:2009/(R)2012 and A2:2010/(R)2012, CAN/CSA-C22.2 No. 60601-1:14, IEC 60601-2-52:2009/A1:2015, CAN/CSA-C22.2 No. 60601-2-52:11 with Amendment 1:2017.
	In accordance with European Directive 2012/19/EU on Waste Electrical and Electronic Equipment (WEEE) as amended, this symbol indicates that the product should be collected separately for recycling. Do not dispose of as unsorted municipal waste. Contact local distributor for disposal information. Ensure infected equipment is decontaminated prior to recycling.

Table of Contents

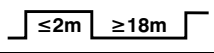
Warning/Caution/Note Definition	3
Summary of safety precautions	3
Introduction	6
Product description	6
Indications for use	6
Clinical benefits	7
Contraindications	7
Expected service life	7
Disposal/recycle	7
Specifications	7
European REACH - ProCuity	9
Wi-Fi radio specifications option	10
Bluetooth radio specifications option	11
System requirements and recommendations for iBed Wireless option	12
Product illustration	13
Applied parts	14
Contact information	14
Serial number location	15
Setup	16
Setting up wired nurse call communication	16
Setting up iBed Wireless option	17
Setting up cable-free nurse call communication option	17
Operation	19
Plugging or unplugging the product	19
Charging the battery	19
Storing the power cord	20
Transporting the product	21
Applying or releasing the brakes	21
Applying or releasing Steer-Lock™	22
Transporting the product with Zoom drive option	23
Stopping the product with Zoom drive option	25
Raising or lowering the Zoom handles option	25
Zoom drive modes	26
Zoom control panel, throttle handle option	26
Activating the CPR release handle	28
Removing or replacing the headboard	28
Removing or replacing the footboard	28
Raising the siderails	29
Lowering the siderails	30
Extending or retracting the bed extender	31
Securing patient restraint straps	31
Securing a Foley bag to the Foley bag hook	32
Activating nurse call	32
Connecting peripheral equipment to the auxiliary outlet	33
Connecting a patient device to the USB port option	33
Isolibrium PE support surface option	33
Preparing Isolibrium PE for a new patient option	33
Preparing bed positions for Isolibrium PE functions option	34
Footboard control panel, advanced - Pressure option	34
Footboard control panel, advanced - Turn option	35
Footboard control panel, advanced - Pulmonary option	37
Operator control panel, basic, outside siderail	38
Operator control panel, advanced, outside siderail option	39
Patient control panel, inside siderail	40
Pendant, basic option	41

Pendant, advanced option	42
Footboard control panel - Home	44
Footboard control panel - Position	44
Footboard control panel, advanced - Home option	45
Footboard control panel - Motion lock	47
Footboard control panel, advanced - Motion lock option	48
Footboard control panel - Scale	49
Zeroing/taring the scale	49
Weighing a patient	50
Adding or removing equipment	50
Footboard control panel, advanced - Scale option	51
Zeroing/taring the scale, advanced option	52
Weighing a patient, advanced option	52
Adding or removing equipment, advanced option	52
Footboard control panel - Bed Exit	53
Arming or disarming Bed Exit	54
Footboard control panel, advanced - Bed Exit option	55
Arming or disarming Bed Exit, advanced option	56
Footboard control panel - iBed Watch	56
Enabling or disabling iBed Watch	57
Footboard control panel, advanced - iBed Watch option	57
Enabling or disabling iBed Watch, advanced option	58
Footboard control panel - Menu	59
Footboard control panel, advanced - Menu option	60
Clearing a detected motion obstruction	62
Accessories and parts	64
Raising or lowering the HAVASU IV pole option	64
Attaching or removing the patient helper option	65
Adjusting the patient helper option	66
Attaching the oxygen bottle holder	67
Attaching the defibrillator tray option	67
Operating the defibrillator tray option	68
Cleaning and disinfecting with SideKick®	69
Cleaning	70
Disinfecting	71
Preventive maintenance	72
Wireless notifications	74
Wireless coexistence notifications	75
EMC information	76

Warning/Caution/Note Definition

The words **WARNING**, **CAUTION**, and **NOTE** carry special meanings and should be carefully reviewed.

WARNING

Alerts the reader about a situation which, if not avoided, could result in death or serious injury. It may also describe potential serious adverse reactions and safety hazards.

CAUTION

Alerts the reader of a potentially hazardous situation which, if not avoided, may result in minor or moderate injury to the user or patient or damage to the product or other property. This includes special care necessary for the safe and effective use of the device and the care necessary to avoid damage to a device that may occur as a result of use or misuse.

Note - Provides special information to make maintenance easier or important instructions clearer.

Summary of safety precautions

Always read and strictly follow the warnings and cautions listed on this page. Service only by qualified personnel.

WARNING

- Always use Stryker approved support surfaces that have been tested for compatibility with the product frame to avoid the risk of patient entrapment.
- Always plug the product into a grounded, hospital grade wall outlet. You can only achieve grounding reliability when you use a hospital grade wall outlet. This product is equipped with a hospital-grade plug for protection against electric shock hazard.
- Always use a Stryker supplied interface cable. Use of any other cable may cause the product to not function as intended, which may result in patient or user injury.
- Always plug the product into a hospital grade protective earthed outlet when you connect the product to the applicable connection with an interface cable.
- Always map the **iBed Locator** or **Secure Connect** to the location to provide location information. If you move an **iBed Locator** or **Secure Connect** after it has been set up and mapped, you must remap to the new location.
- Always connect this product to a supply mains with protective earth to avoid the risk of electric shock.
- Always connect the product to an appropriate power source if the loss of power would result in unacceptable risk.
- Always allow enough clearance between the head end of the product and the adjacent wall, so you can unplug the power cord from the wall outlet.
- Always store the power cord before you transport the product.
- Always unplug the power cord from the wall outlet if you detect overheating of the battery, cables, or cords. Do not use the product until it has been inspected, serviced, and confirmed to work as intended by maintenance personnel.
- Always replace the battery after it surpasses its expected service life.
- Do not open the battery.
- Do not expose the battery to excessive heat.
- Do not spill liquid onto the battery or submerge the battery in liquid.
- Always store the power cord to avoid the risk of entanglement, damage to the power cord, or potential shock hazards. If the power cord is damaged, remove the product from service.
- Always use two people when you transport the product.
- Always lock the siderails in the highest height position with the sleep surface horizontal when you transport a patient.
- Always keep limbs, hands, fingers, and other body parts clear of mechanisms and gaps.
- Always check that there are no obstacles near the product. Injury to the patient, operator, bystanders or damage to the frame or surrounding equipment could occur if you collide with an obstacle.
- Do not attempt to transport the product laterally. This may cause the product to tip.
- Always apply the brakes when a patient is getting into or out of the product to avoid instability.
- Always apply the brakes when the patient is unattended.

- Do not apply the brakes to slow or stop the product while the product is in motion.
- Always unplug the power cord before you transport the product.
- Always release the brakes before you transport the product. Do not transport the product with the brakes applied.
- Do not transport the product laterally after you apply the **Steer-Lock** pedal. The product cannot swivel when you transport with **Steer-Lock**.
- Do not attempt to release **Steer-Lock** while the product is in motion.
- Do not attempt to transport the product laterally after you apply the **Zoom** motorized drive. The **Zoom** motorized drive cannot swivel.
- Do not use the brake to slow or stop the product while it is in motion.
- Always lower the product to its lowest height when the patient is unattended to reduce the risk of injury due to patient falls.
- Always lock the controls when the patient is unattended.
- Always route the cables, wires, and tubing from other equipment so that parts of the product do not pinch them.
- Do not use the headboard for CPR support.
- Always set the siderail position for appropriate patient safety.
- Only use hospital grade electric equipment consuming 5A or less with the auxiliary outlet. The use of standard electric equipment may bring the current leakage to a level unacceptable for hospital equipment.
- Do not use the auxiliary outlet for life sustaining equipment.
- Do not load **Isolbrium** PE above the safe working load of 460 lb (208.6 kg).
- Always route the cables, wires, and tubing from other equipment so that parts of the product do not pinch them during operation.
- Always lock the siderails in the highest height position during operation.
- Do not leave the patient unattended during operation.
- Do not zero the scale or weigh the patient during operation.
- Do not extubate or intubate the patient during operation.
- Always center the patient on the support surface and check frequently to maintain proper position.
- Always lock the controls when the patient's condition requires extra safety measures.
- Do not use the scale system reading as a reference for medical treatment. The scale system assists only to monitor the patient's weight variation.
- Do not use Bed Exit to replace patient monitoring protocol. Bed Exit is intended only to aid in the detection of a patient exiting the product.
- Do not use manual override to avoid the risk of product damage.
- Always use two people to attach or remove the patient helper.
- Do not load the patient helper above the safe working load of 200 lb (90.7 kg).
- Portable RF communications equipment, including peripherals such as antenna cables and external antennas, should be no closer than 12 inches (30 cm) to any part of **ProCuity** bed series, including cables specified by the manufacturer.
- Avoid stacking or placing equipment adjacent with other equipment to prevent improper operation of the product. If such use is necessary, carefully observe stacked or adjacent equipment to make sure that they operate properly.
- The use of accessories, transducers, and cables, other than those specified or provided by the manufacturer, could result in increased electromagnetic emissions or decreased electromagnetic immunity and result in improper operation.

CAUTION

- Improper usage of the product can cause injury to the patient or operator. Operate the product only as described in this manual.
- Do not modify the product or any components of the product. Modifying the product can cause unpredictable operation resulting in injury to patient or operator. Modifying the product also voids its warranty.
- Do not clean, disinfect, service, or perform maintenance while the product is in use.
- Always plug the product into a hospital grade protective earthed outlet when not in use to maintain a sufficient battery charge and to maximize product performance while operating on battery power.
- Always replace batteries that have corrosion at the terminals, display cracking, have expanded or bulging sides, or no longer can maintain a full charge.
- Always use authorized batteries when you replace the batteries. Use of unauthorized batteries may lead to unpredictable system performance.

- Do not pinch the power cord in the bed frame.
 - Do not use the siderails as a push or pull device. Always move the product using the integrated handles in the headboard and footboard.
 - Always remove the patient helper before you transport the product.
 - Do not use the patient helper as a push or pull device.
 - Do not use the oxygen bottle holder as a push or pull device.
 - Do not use the IV pole as a push or pull device.
 - Always make sure that the IV pole is at a low height during transport.
 - Do not transport the product on inclines greater than 6 degrees (10% grade).
 - Always clear the product of obstacles before you use motion functions.
 - Always confirm that all persons and equipment are away from the area below and around the Fowler before you activate the CPR release handle. The CPR release handle is for emergency use only.
 - Do not load the IV pole above the safe working load of 17.6 lb (8 kg).
 - Do not load an individual IV pole hook above the safe working load of 8.8 lb (4 kg).
 - Always secure the lifting pole in the mounting bracket before you adjust the patient helper.
 - Always check that the patient helper mounting bracket is secure before use.
 - Do not load the standard oxygen bottle holder (300900450050) above the safe working load of 15 lb (6.8 kg).
 - Do not load the large oxygen bottle holder (300900450150) above the safe working load of 40 lb (18.1 kg).
 - Do not load the defibrillator tray above the safe working load of 40 lb (18.1 kg).
 - Do not use the defibrillator tray as a push or pull device.
 - Always unplug the power cord from the wall outlet when large spills occur near the circuit boards, cables, and motors. Remove the occupant from the product, clean up the fluid, and inspect the product. Fluids can cause unpredictable operation and decreased functionality of any electrical product. Do not return the product to service until dry and tested for safe operation.
 - Always wipe down with clean water (or 70% isopropyl alcohol, if using **Virex®** TB) and dry each product after disinfecting. Some disinfectants are corrosive in nature and may cause damage to the product. If you do not rinse and dry the product, you may leave a corrosive residue on the surface of the product. This corrosive residue could cause premature degradation of critical components. Failure to follow these disinfecting instructions may void your warranty.
-

Introduction

This manual assists you with the operation or maintenance of your Stryker product. Read this manual before operating or maintaining this product. Set methods and procedures to educate and train your staff on the safe operation or maintenance of this product.

CAUTION

- Improper usage of the product can cause injury to the patient or operator. Operate the product only as described in this manual.
 - Do not modify the product or any components of the product. Modifying the product can cause unpredictable operation resulting in injury to patient or operator. Modifying the product also voids its warranty.
-

Note

- This manual is a permanent part of the product and should remain with the product even if the product is sold.
- Stryker continually seeks advancements in product design and quality. This manual contains the most current product information available at the time of printing. There may be minor discrepancies between your product and this manual. If you have any questions, contact Stryker Customer Service or Technical Support at 1-800-327-0770.

Product description

The Stryker **ProCuity™** bed series is a powered, adjustable hospital bed used in combination with a patient support surface.

The product contains siderails that you can lock into three positions, a headboard, and a footboard. The product has Fowler, Gatch, and lift articulation capabilities, which aid to adjust surface contour, angle, and bed height. The product transports patients aided by the optional **Zoom®** function. The product features manual and electronic brakes. Product height range is adjustable between 11.5 inches to 30 inches (29.2 cm to 76.2 cm), and 14 inches to 32 inches (35.6 cm to 81.3 cm) for a product with the optional **Zoom** function. The Fowler raises from 0 to 65 degrees (± 5 degrees).

The product is designed with various features, including Bed Exit, auxiliary AC outlet, bed extender, an IV pole, and the following:

- Integrated scale to track patient weight fluctuation throughout a patient's stay.
- **iBed®** Watch to set various bed parameters to track bed position. **iBed** Watch provides visual alerts, while Bed Exit provides both visual and audible alerts.
- **iBed** Wireless option to monitor product parameters that a healthcare provider (HCP) views or sets at the bedside or from a remote location.
- Motion and feature lockouts, set by the HCP, to limit patient accessible controls for compliance to set bed parameters.
- Nurse call capability through a wired connection or cable-free headwall with **Secure® Connect™** option
- Integrates with the 2973 **Isolibrum®** PE support surface option to provide pressure redistribution, lateral rotation, turn assist, low air loss, and max inflate functions.
- Patient device holder with optional USB charger.

Indications for use

The **ProCuity** bed series is intended for use to assist with positioning, therapy, recovery, support, and transport of patients within a healthcare delivery organization (HDO). The intended user is both HCPs (nurses, nurse aides, and medical doctors) and human patients.

This product can be used with human patients that weigh more than 60 lb (27.2 kg), with a maximum height of 84 inches (213.4 cm) without the bed extender or 96 inches (243.84 cm) with the bed extender.

The scale output is not intended to be used to determine diagnosis or treatment.

iBed Wireless with **iBed** Watch provides clinical staff the ability to monitor specific bed parameters from a remote location within a healthcare facility through unilateral data communication. The bed parameters include bed brake status, siderail

position, Bed Exit zone, sensitivity, **iBed Watch** enablement, bed motion lock, and bed scale observation. The desired bed parameters will be set by clinicians at bedside. **iBed Wireless** with **iBed Watch** is intended for use only with specific enabled Stryker beds that are verified and validated with the **iBed Wireless** software and is not intended to provide bed status information for non-Stryker beds. Patient health information is not communicated or stored.

The **ProCuity** bed series has not been evaluated for compliance to bed standard BS EN 50637. This product is not intended for use with pediatric patients or adult patients with atypical anatomy in markets that recognize this bed standard for market authorization.

This product is not intended for:

- Behavioral health patient use
- Oxygen rich environments
- Sterile environments
- Home care or non-institutional long-term care facility settings

Clinical benefits

Patient treatment, patient positioning, and diagnostic

Contraindications

None known.

Expected service life

The **ProCuity** bed series has a 10 year expected service life under normal use conditions and with appropriate periodic maintenance.



The backup batteries have a two year expected service life under normal use conditions.

Disposal/recycle

Always follow the current local recommendations and/or regulations governing environmental protection and the risks associated with recycling or disposing of the equipment at the end of its useful life.

Specifications

WARNING - Always use Stryker approved support surfaces that have been tested for compatibility with the product frame to avoid the risk of patient entrapment.

	Safe working load Note: Safe working load indicates the sum of the occupant, accessories, and mattress weight.		550 lb	249.5 kg
	Maximum patient weight		500 lb	226.8 kg
	Mass of equipment with safe working load	Standard	1125 lb	510.3 kg
		Zoom (ZM option)	1235 lb	560.2 kg
Product weight		Standard	575 lb	260.8 kg
		Zoom (ZM option)	685 lb	310.7 kg

Scale system capacity maximum		551.2 lb	250 kg
Scale system accuracy (non-NAWI)		± 3 lb (1.4 kg) of the total patient weight for patients who weigh 60 lb (27.2 kg) to 100 lb (45.4 kg)	
		± 3% of the total patient weight for patients who weigh 100 lb (45.4 kg) to 550 lb (249.5 kg)	
	Scale system accuracy (NAWI) MAX = 250 kg, MIN = 20 kg, e = 2 kg, Tare = -60 kg	± 2.2 lb (1 kg) for patients who weigh 44 lb (20 kg) to 220 lb (100 kg)	
		± 4.4 lb (2 kg) for patients who weigh 220 lb (100 kg) to 551 lb (250 kg)	
Patient sleep surface	Standard	84 in. x 35 in.	213.4 cm x 88.9 cm
	Bed extender	96 in. x 35 in.	243.8 cm x 88.9 cm
Overall length and width	Standard	90.25 in. x 42 in.	229.2 cm x 106.7 cm
	Bed extender	104.25 in. x 42 in.	264.8 cm x 106.7 cm
	Zoom (ZM option)	93 in. x 42 in.	236.2 cm x 106.7 cm
	Zoom (ZM option) bed extender	107 in. x 42 in.	271.8 cm x 106.7 cm
Bed height to top of seat litter	Standard	11.5 in. to 30 in.	29.2 cm x 76.2 cm
	Zoom	14 in. to 32 in.	35.6 cm x 81.3 cm
Under bed clearance		5.25 in. (13.3 cm) with bed height 15.7 in. (39.9 cm) to 20 in. (50.8 cm)	
		5.75 in. (14.6 cm) with bed height 20 in. (50.8 cm) and above	
Gatch position		0° to 30° ± 5°	
Fowler position		0° to 65° ± 5°	
Trendelenburg and reverse Trendelenburg		+12° to -10° ± 5°	
Electrical requirements Note - Class I Electrical Equipment: Protection against electrical shock relies on connection to protective earth of an appropriately rated hospital grade outlet.		120 VAC, 60 Hz, 8A 100-240V~ 50-60 Hz, 8A	230 VAC, 50 Hz, 8A 100-240V~ 50-60 Hz, 8A
Hospital grade auxiliary outlet		120 VAC, 60 Hz, 8A 100-240V~ 50-60 Hz, 8A	230 VAC, 50 Hz, 8A 100-240V~ 50-60 Hz, 8A
Bed battery voltage Note - Always replace with Stryker approved batteries.		12 VDC, 1.2 Ah (x2) (Stryker part number: 700000341245)	
Zoom battery voltage Note - Always replace with Stryker approved batteries.		12 VDC, 20 Ah (x2) (Stryker part number: 700000341246)	
Duty cycle		2 minutes ON, 18 minutes OFF	
Application environments		1, 2, 3, and 5 per IEC 60601-2-52	
Maximum acoustic sound pressure		64 dBa	

Compatible support surfaces	Length		Width		Thickness	
Model 2850 ComfortGel™	84 in.	213.4 cm	35 in.	88.9 cm	7 in.	17.8 cm
Model 2860 IsoFlex®	84 in.	213.4 cm	35 in.	88.9 cm	6 in.	15.2 cm
Model 2872 IsoTour™	84.25 in.	214 cm	35.5 in.	90.2 cm	9.5 in.	24.1 cm
Model 2815 ProForm®	84 in.	213.4 cm	35 in.	88.9 cm	6 in.	15.2 cm
Model 2940/ 2941 IsoAir®	84 in.	213.4 cm	35 in.	88.9 cm	7 in.	17.8 cm
Model 2973 Isolibrium® PE	84 in.	213.4 cm	35 in.	88.9 cm	8 - 10.5 in.	20.3 - 26.7 cm

Stryker reserves the right to change specifications without notice.

Specifications listed are approximate and may vary slightly from product to product or by power supply fluctuations.

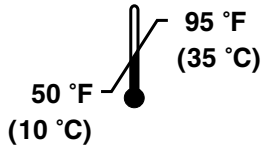
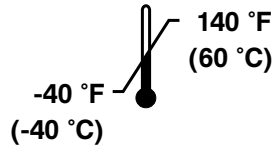
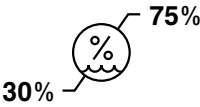
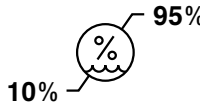
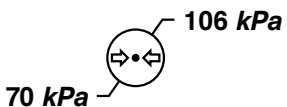
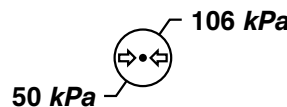
Environmental conditions	Operation	Storage and transportation
Ambient temperature		
Relative humidity (non-condensing)		
Atmospheric pressure		

European REACH - ProCuity

In accordance with the European REACH regulation and other environmental regulatory requirements, the components that contain declarable substances are listed.

Description	Number	Substance of very high concern (SVHC) chemical name
Actuators	300900020040, 300900070040, 300900120040, 300900140040	Lead
Advanced wired bedside room interface board	300900380910	Lead
Advanced wireless bedside room interface board	300900380920	Lead

Description	Number	Substance of very high concern (SVHC) chemical name
Brake controller board	300900030900	Diboron-trioxide, lead, lead-monoxide
Display controller board (basic)	300900220900	Lead
Display controller board (advanced)	300900220910	Lead
Display assembly (advanced)	300900220300	Lead
Gateway assembly	300900680910	Diboron-trioxide, lead, lead-monoxide, 1-methyl-2-pyrrolidone
Two-stage IV pole assembly	300900350010, 300900350100, 300900350200, 300900350250	Lead
Main controller board (basic)	300900100120	Diboron-trioxide, lead, lead-monoxide
Main controller board (advanced)	300900100130	Diboron-trioxide, lead, lead-monoxide
Powder coated weldments	300900010100, 300900670160, 300900670100, 300900020055, 300900150100, 300900120100, 300900120025, 300900120020, 300900120050, 300900140100, 300900100110, 300900100100, 300900020150, 300900450055, 300900450110, 300900020125, 300900110025	2-methylimidazole
USB charger board	300900110900	Lead
Zoom controller board	300900070050	Lead, lead-monoxide

Wi-Fi radio specifications option

Manufacturer/model	Silex SX-SDMAC-2832S+
Chipset	Qualcomm Atheros QCA9377-3
IEEE 802.11	a/b/g/n/ac
RF bands	2.4 GHz, 5 GHz
Encryption	AES and TKIP (TKIP is not supported with WPA2)
Authentication	WPA Personal/Enterprise and WPA2 Personal/Enterprise
802.1X	PEAP-MSCHAP - v2
Client certificates	Cannot accept or upload certificates
Supported data rates	802.11b: 1-54 Mbps 802.11a/g: 6-54 Mbps 802.11n: MCS0-7 802.11ac: MCS0-9 (compatible)
Hash function compatibility	SHA-1 and SHA-2 server side certificate recognition for PEAP-MSCHAP - v2

Channel plan	2.4 GHz: All channels supported 5 GHz: All channels supported (Recommend against the use of DFS and ISM channels)
Other	Leverage hospital SSID Support for 802.11r Support for Cisco CCX (Fast roaming)

Item	Specification - Chipset QCA9377-3 (Qualcomm Atheros)				Unit
	Band	Mode	Min	Max	
Operating frequencies	2.4GHz	11b	2412	2472	MHz
		11g/n/ac 20MHz	2412	2472	MHz
		11g/n/ac 40MHz	2422	2462	MHz
	5GHz	11a/n/ac 20MHz	5180	5825	MHz
		11n/ac 40MHz	5190	5795	MHz
		11ac 80MHz	5210	5775	MHz
Frequency steps	2.4GHz	11b/g/n	5		MHz
	5GHz	11a/n/ac 20MHz	20		MHz
		11n/ac 40MHz	40		MHz
		11ac 80MHz	80		MHz
Modulation types	Not applicable	11b	DSSS (DBPSK, DQPSK, CCK)		Not applicable
	Not applicable	11a/g/n	OFDM (BPSK, QPSK, 16QAM, 64QAM)		Not applicable
	Not applicable	11ac	OFDM (BPSK, QPSK, 16QAM, 64QAM, 255QAM)		Not applicable
Maximum ERP	Not applicable	Not applicable	-8.648/21.352		dBW/dBm

Note

- ProCuity security white paper available upon request.
- ProCuity MDS2 form available upon request.
- ProCuity software bill of materials available upon request.

Bluetooth radio specifications option

Item	Specification - Chipset WT32i (Silicon Labs)			Unit
	Channel	Min	Max	
Operating frequencies	79	2.4	2.4835	GHz
Receiving bandwidth	Not applicable	1		MHz
Maximum ERP	Not applicable	-21.148/8.852		dBW/dBm

System requirements and recommendations for iBed Wireless option

Client device data usage:

- The client uses 10-15 KB per connected device every 40 seconds.
- The client uses an additional 5-25 KB per device for each subscription that is created by Stryker (**SEM/iBed Vision**) and/or a third-party vendor like Connexall, Capsule, Epic, and Cerner.

Note - Based on network conditions, device messages are typically sent in near real time or in up to five minutes while connected. This depends on device activity like applying the brakes, adjusting the rails, alarms, and how the third-party defines subscription times.

Customer network communication requirements for **iBed** Wireless option:

LAN environment		
Client/server communication	IPv4 only	Not applicable
Client device IP allocation	Static	<ul style="list-style-type: none"> • If Static - Unique IP address will be required for each client MAC address
	DHCP	<ul style="list-style-type: none"> • If DHCP and not using a DNS name - Each client MAC address will need a reserved IP address • If DHCP and using a DNS name - It is required to create a unique name for each client MAC address for client management <ul style="list-style-type: none"> ◦ Stryker recommends using the Stryker client host name when the Stryker device connects to the wireless network - Example: SYK-00197b12365 so it may look like http://SYK-00197b12365.hosp.org
Server IP allocation	Static IP required	Not applicable
VLAN	New, existing	Install iBed Wireless on a separate VLAN

IP traffic environment		
Source	Protocol / Port number	Destination
iBed Server	TCP/443	iBed Wireless Client
iBed Wireless Client	TCP/443	iBed Server

Customer WLAN environment		
Supported wireless vendors	Cisco, Aruba	Required
Access point (AP) types	Controller-based or autonomous	Required
Channel width	2.4 GHz: 20 MHz 5 GHz: 20/40 MHz	Required
Channel utilization	Consistently less than 30%	Recommended

Customer WLAN environment		
Signal strength range (minimum)	2.4 GHz: -67dBm +0/-8dBm 5 GHz: -67dBm +0/-8dBm	Required
Minimum SNR	Minimum 20dB	Required
Priority queuing	Prioritized over best effort traffic	Recommended
Client exclusion	Disabled	Recommended
Client load balancing	Disabled	Recommended
Max number of SSIDs	5	Recommended
Authentication timeouts	Add session timeout of at least 24 hours	Recommended
Microwave ovens	Avoid using microwave ovens near Stryker wireless products as this will cause degradation of service or no service due to electromagnetic or radio-frequency (RF) interference (<i>Wireless coexistence notifications</i> (page 75)).	Recommended
LTE-U cellular band	LTE-U introduces a new standalone cellular band (B46) as a part of the 3GPP Release 16 (3GPP TR 21.916) or "5th Generation Cellular Release" that coexists with 5Ghz Wi-Fi (U-NII-1, -2A, -2B, -2C, -3, and -4). Any cellular devices/repeaters should have this cellular band (B46) disabled to prevent degradation of service or no service due to electromagnetic or radio-frequency (RF) interference (<i>Wireless coexistence notifications</i> (page 75)).	Recommended

Product illustration

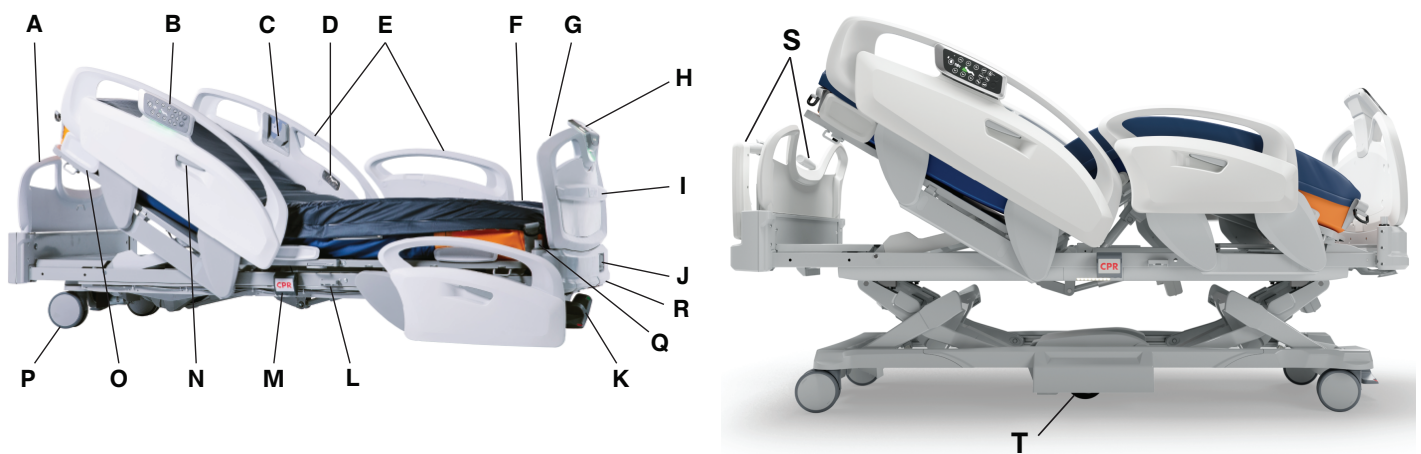

Figure 1 – ProCuity bed series

A	Headboard	K	Brake/steer pedal
B	Operator control panel	L	Foley bag hook
C	Patient device holder	M	CPR release handle
D	Patient control panel	N	Siderail release
E	Siderail	O	Mattress retainer
F	Support surface	P	Caster
G	Footboard	Q	Traction socket
H	Footboard control panel	R	Bed extender release handle
I	Integrated pump rack	S	Zoom handles option
J	Auxiliary outlet	T	Zoom wheel option

Applied parts



Figure 2 – Type B applied parts

Contact information

Contact Stryker Customer Service or Technical Support at: 1-800-327-0770.

Stryker Medical
 3800 E. Centre Avenue
 Portage, MI 49002
 USA

Note - The user and/or the patient should report any serious product-related incident to both the manufacturer and the Competent authority of the European Member State where the user and/or patient is established.

To view your operations or maintenance manual online, see <https://techweb.stryker.com/>.

Have the serial number (A) of your Stryker product available when calling Stryker Customer Service or Technical Support. Include the serial number in all written communication.

Serial number location

You can find the serial number (A) below the headboard at the head of the bed (Figure 3).

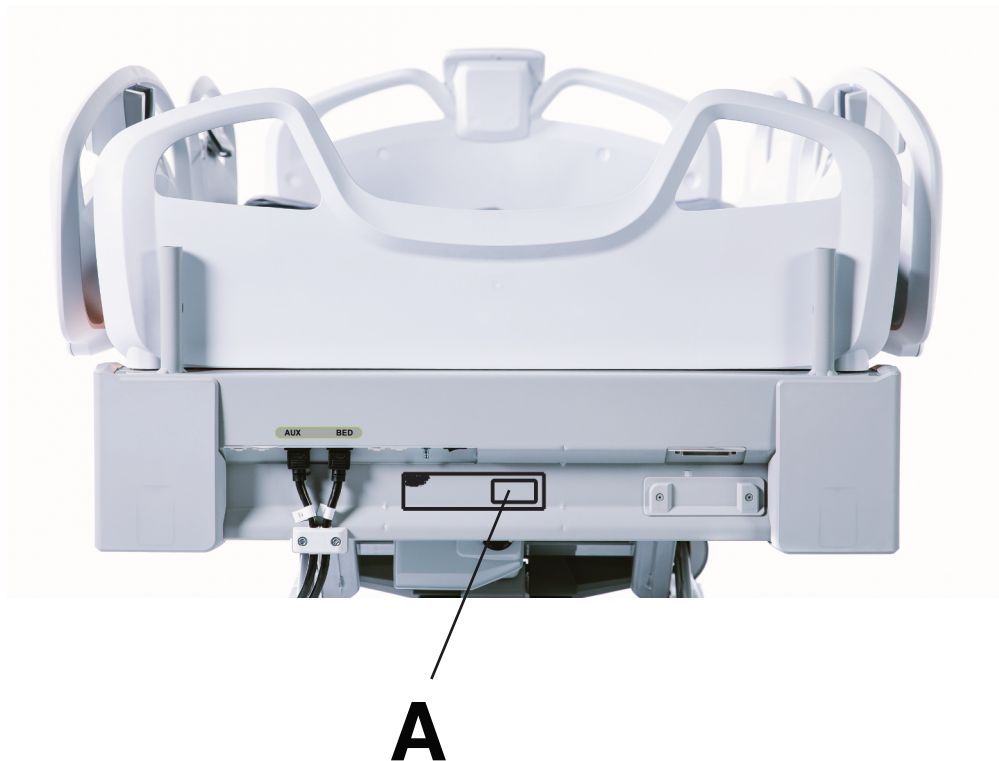

Figure 3 – Serial number location

Setup

WARNING - Always plug the product into a grounded, hospital grade wall outlet. You can only achieve grounding reliability when you use a hospital grade wall outlet. This product is equipped with a hospital-grade plug for protection against electric shock hazard.

CAUTION - Do not clean, disinfect, service, or perform maintenance while the product is in use.

Note - Allow the product to reach room temperature before you conduct any setup or test functional operations.

To setup and test the functionality of the product:

1. Push the Circuit Breaker Reset button on the **Zoom** base (Figure 7) (**Zoom** option only).
2. Plug the power cord into a wall outlet.
3. Turn on the battery switch (*Charging the battery* (page 19)).
4. Check that the display at the foot end of the product comes on.
5. Siderails raise, lower, lock in the up position, and lock in the intermediate position when lowered (*Raising the siderails* (page 29), *Lowering the siderails* (page 30)).
6. Apply the brake. Push on the product to make sure that all four casters are locked (*Applying or releasing the brakes* (page 21)).

Note - The **Brake** icon (H) located on the footboard control panel (*Footboard control panel - Home* (page 44)) illuminates when you apply the brakes.

7. Release the brake. Push on the product to make sure that all four casters are unlocked.
8. Raise the Fowler (head of bed) to approximately 60°.
9. Pull the CPR release handle to make sure that the back will drop with minimal effort (*Activating the CPR release handle* (page 28)).
10. Perform each function on the footboard control panel to make sure that each function works (*Footboard control panel - Home* (page 44), *Footboard control panel - Position* (page 44)).
11. Perform each function on each control panel on the head end siderails to make sure that each function works (*Operator control panel, basic, outside siderail* (page 38), *Operator control panel, advanced, outside siderail option* (page 39)).
12. Activate the motion interrupt system. Press **Bed height down** (J) (*Footboard control panel - Position* (page 44)) to lower the litter. As the litter lowers, push up on the motion interrupt panel under the litter bed extender to make sure that downward motion stops. Release the panel and allow downward motion to continue.

Setting up wired nurse call communication

WARNING

- Always use a Stryker supplied interface cable. Use of any other cable may cause the product to not function as intended, which may result in patient or user injury.
 - Always plug the product into a hospital grade protective earthed outlet when you connect the product to the applicable connection with an interface cable.
-

Note

- The nurse call interface connects to nurse call systems designed to comply with appropriate standards (i.e. IEC 60601-1, IEC 60950, UL 1069) and rated for a maximum of 42.4Vpk, 60VDC with the exception of the United States, which is rated for a maximum of 42.4VDC.
- The product is equipped with an input that accepts a DB-37 nurse call cable.

To setup nurse call communication:

1. Plug the interface cable into the 37-pin connector on the litter frame at the head end of the product (A) (Figure 4).

Note - Only connect the 37-pin connector to the 37-pin connection on the product.

2. Plug the interface cable into the applicable connection (patient station, head wall, or docker station).
3. Press the **Nurse call** button (B) to verify the connection between the product's nurse call signal and the hospital's nurse call system (*Operator control panel, basic, outside siderail* (page 38), *Operator control panel, advanced, outside siderail option* (page 39)).

To activate nurse call communication, see *Activating nurse call* (page 32).

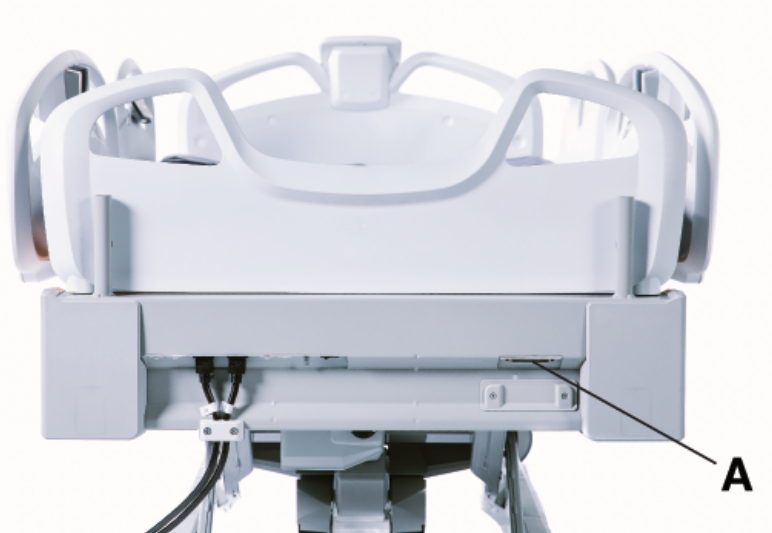

Figure 4 – 37-pin connector

Setting up iBed Wireless option

WARNING - Always map the **iBed Locator** or **Secure Connect** to the location to provide location information. If you move an **iBed Locator** or **Secure Connect** after it has been set up and mapped, you must remap to the new location.

To setup your product to receive a wireless connection, you must set up the **iBed Locator** or **Secure Connect** on the wall at the head end of the product. The **iBed Locator** or **Secure Connect** communicates with the product. For instructions about how to mount the **iBed Locator** or **Secure Connect**, see the **iBed Locator Installation Manual** or **Secure Connect Installation/Configuration Manual**.

For any set up questions, contact Stryker Technical Support at:

- Call: (800) 327-0770
- E-mail: medicaliBedWirelessSupport@stryker.com

Note - You must load the wireless connection settings before the device will communicate with the **iBed Server** application. See the **iBed Server Installation/Configuration Manual**.

Setting up cable-free nurse call communication option

When paired with **Secure Connect** the product can send a cable-free nurse call signal. This setup will be performed by authorized personnel before the product is placed into service.

To test wireless nurse call communication:

1. Make sure that the product is in a position of -6° reverse Trendelenburg or less to establish a first connection.
2. Apply the brakes (*Applying or releasing the brakes* (page 21)).

Note

- Apply the brakes for **Secure Connect** and the product to establish a first connection.

- If the product is equipped with the patient helper option, the product must be in a flat position and either be 17.5 in. (44.5 cm) from the wall at a 14 in. (35.6 cm) product height (or more) or within 3 ft (0.9 m) from the wall at a 22 in. (55.9 cm) product height (or more) to establish a first connection.
 - Make sure that the product is no closer than 17.5 in. (44.5 cm) from the wall for connection.
3. Press the **Nurse call** button (B) to verify the connection between the product's nurse call signal and the hospital's nurse call system (*Operator control panel, basic, outside siderail* (page 38), *Operator control panel, advanced, outside siderail option* (page 39)).

To activate nurse call communication, see *Activating nurse call* (page 32).

Operation

Plugging or unplugging the product

WARNING

- Always connect this product to a supply mains with protective earth to avoid the risk of electric shock.
 - Always connect the product to an appropriate power source if the loss of power would result in unacceptable risk.
 - Always allow enough clearance between the head end of the product and the adjacent wall, so you can unplug the power cord from the wall outlet.
 - Always store the power cord before you transport the product.
-

Note - Make sure that the product is plugged in when not in transport.

The product is equipped with two power cords, the auxiliary outlet cord (A) and the bed power cord (B) (Figure 5).

To plug in the product, plug the power cord into a hospital grade protective earthed outlet.

To unplug the product, grasp the mold near the outlet and pull in a direction parallel to the floor (not at an angle).

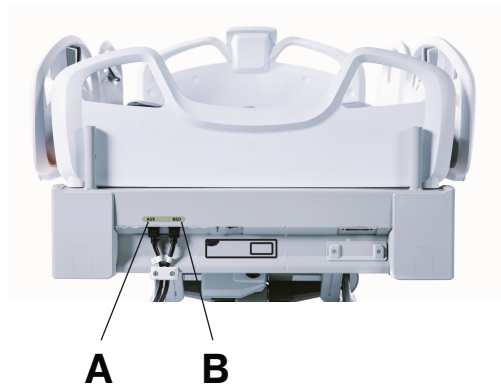

Figure 5 – Auxiliary and bed power cords

Charging the battery

WARNING

- Always unplug the power cord from the wall outlet if you detect overheating of the battery, cables, or cords. Do not use the product until it has been inspected, serviced, and confirmed to work as intended by maintenance personnel.
 - Always replace the battery after it surpasses its expected service life.
 - Do not open the battery.
 - Do not expose the battery to excessive heat.
 - Do not spill liquid onto the battery or submerge the battery in liquid.
-

CAUTION

- Always plug the product into a hospital grade protective earthed outlet when not in use to maintain a sufficient battery charge and to maximize product performance while operating on battery power.
 - Always replace batteries that have corrosion at the terminals, display cracking, have expanded or bulging sides, or no longer can maintain a full charge.
 - Always use authorized batteries when you replace the batteries. Use of unauthorized batteries may lead to unpredictable system performance.
-

This product is equipped with a battery backup system that charges when the product is plugged into a wall outlet. The battery backup system allows the operator to use the product when the product is unplugged, during a power failure, or during transport. The battery backup system activates when you unplug the product.

Always check battery backup function. Replace the battery if it does not perform as intended during preventive maintenance.

To charge the battery:

1. Plug the power cord into the wall outlet.
2. Turn on the battery switch (A) at the head end of the product (Figure 6).

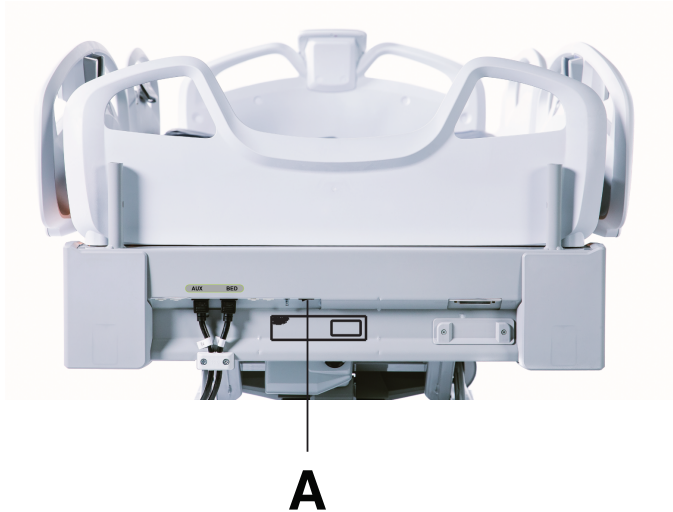

Figure 6 – Battery switch

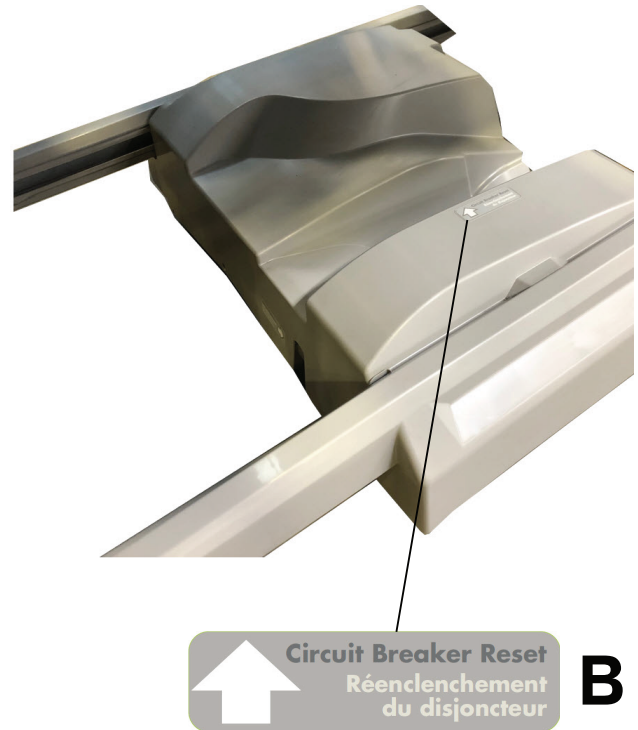

Figure 7 – Zoom Circuit Breaker Reset

Note

- The battery will not charge when the battery switch is off.
- Make sure that the battery switch is off when the product is placed into storage.
- Trip the Circuit Breaker Reset (B) when you place the product into storage (**Zoom** option only) (Figure 7).

The battery has a full charge within eight hours.

Storing the power cord

WARNING

- Always store the power cord before you transport the product.
 - Always store the power cord to avoid the risk of entanglement, damage to the power cord, or potential shock hazards. If the power cord is damaged, remove the product from service.
-

CAUTION - Do not pinch the power cord in the bed frame.

To store the power cord and auxiliary cord, wrap the cords and secure them with the cord wrap under the head end of the product.

Transporting the product

WARNING

- Always use two people when you transport the product.
 - Always store the power cord before you transport the product.
 - Always lock the siderails in the highest height position with the sleep surface horizontal when you transport a patient.
 - Always keep limbs, hands, fingers, and other body parts clear of mechanisms and gaps.
 - Always check that there are no obstacles near the product. Injury to the patient, operator, bystanders or damage to the frame or surrounding equipment could occur if you collide with an obstacle.
 - Do not attempt to transport the product laterally. This may cause the product to tip.
-

CAUTION

- Do not use the siderails as a push or pull device. Always move the product using the integrated handles in the headboard and footboard.
 - Always remove the patient helper before you transport the product.
 - Do not use the patient helper as a push or pull device.
 - Do not use the oxygen bottle holder as a push or pull device.
 - Do not use the IV pole as a push or pull device.
 - Always make sure that the IV pole is at a low height during transport.
-

To transport the product:

1. Lock the siderail control panel functions (*Footboard control panel - Motion lock (page 47)*).
2. Unplug the power cord from the wall outlet.
3. See *Storing the power cord (page 20)*.
4. Lower the IV pole (*Raising or lowering the HAVASU IV pole option (page 64)*).
5. Turn the oxygen bottle holder in toward the product.
6. Raise and lock the siderails in the highest height position (*Raising the siderails (page 29)*).
7. Release the brakes (*Applying or releasing the brakes (page 21)*).
8. Push the product from the headboard or footboard.

Applying or releasing the brakes

WARNING

- Always apply the brakes when a patient is getting into or out of the product to avoid instability.
 - Always apply the brakes when the patient is unattended.
 - Do not apply the brakes to slow or stop the product while the product is in motion.
-

The brake pedal is at both the head end and foot end of the product.

To apply the brakes, depress the red side of the pedal (Figure 8). The brake pedal locks all four casters to hold the product in place.

To release the brakes, depress the green side of the pedal until the pedal is in the neutral position (Figure 9). This releases all four casters and allows you to move the product.

To apply or release the brakes with the electric brake option, press **Brake** on the operator control panel (*Operator control panel, advanced, outside siderail option (page 39)*) or press **Brake** on the footboard control panel (*Footboard control panel - Home (page 44)*).

Note - The **Brake** icon on the operator control panel (*Operator control panel, basic, outside siderail (page 38)*, *Operator control panel, advanced, outside siderail option (page 39)*) and the **Brake** icon on the footboard control panel (*Footboard control panel - Home (page 44)*) illuminates when you release the brakes.

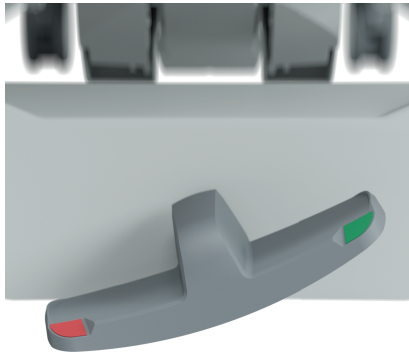

Figure 8 – Applying the brakes

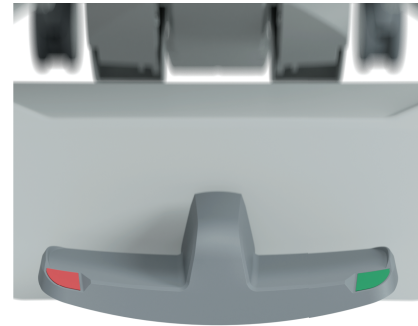

Figure 9 – Releasing the brakes/neutral position

Applying or releasing Steer-Lock™

WARNING

- Always lock the siderails in the highest height position with the sleep surface horizontal when you transport a patient.
 - Always unplug the power cord before you transport the product.
 - Always release the brakes before you transport the product. Do not transport the product with the brakes applied.
 - Do not transport the product laterally after you apply the **Steer-Lock** pedal. The product cannot swivel when you transport with **Steer-Lock**.
 - Do not attempt to release **Steer-Lock** while the product is in motion.
-

The **Steer-Lock** pedal is at both the head end and foot end of the product. **Steer-Lock** guides the product along a straight line when you transport and pivot the product around corners. The **Steer-Lock** pedal locks the casters on the foot end.

To transport with **Steer-Lock**:

1. Align the casters to face the direction of transport.
2. To apply the steer caster, depress the green side of the pedal (Figure 10).

To release **Steer-Lock**, depress the red side of the pedal until the pedal is in the neutral position (Figure 11).

Note - To move in any direction, release the **Steer-Lock** pedal.

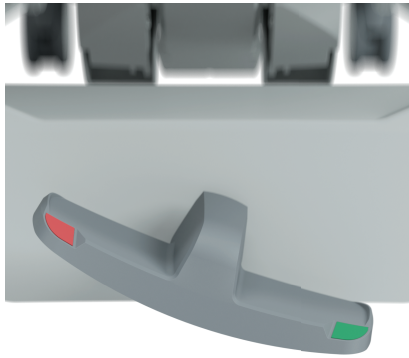

Figure 10 – Applying Steer-Lock

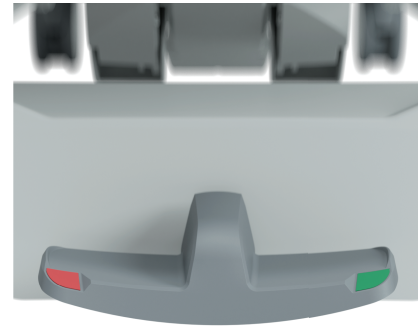

Figure 11 – Releasing Steer-Lock/neutral position

Transporting the product with Zoom drive option

WARNING

- Always store the power cord before you transport the product.
 - Always lock the siderails in the highest height position with the sleep surface horizontal when you transport a patient.
 - Always keep limbs, hands, fingers, and other body parts clear of mechanisms and gaps.
 - Always check that there are no obstacles near the product. Injury to the patient, operator, bystanders or damage to the frame or surrounding equipment could occur if you collide with an obstacle.
 - Do not attempt to transport the product laterally after you apply the **Zoom** motorized drive. The **Zoom** motorized drive cannot swivel.
 - Do not use the brake to slow or stop the product while it is in motion.
-

CAUTION

- Always remove the patient helper before you transport the product.
 - Always make sure that the IV pole is at a low height during transport.
 - Do not transport the product on inclines greater than 6 degrees (10% grade).
-

ProCuity may be equipped with a **Zoom** motorized drive. The **Zoom** motorized drive provides mobility and efficient transport of the product.

To transport the product with **Zoom**:

1. Lock the siderail control panel functions (*Footboard control panel - Motion lock* (page 47)).
2. Unplug the power cord from the wall outlet.
3. See *Storing the power cord* (page 20).
4. Lower the IV pole (*Raising or lowering the HAVASU IV pole option* (page 64)).
5. Turn the oxygen bottle holder in toward the product.
6. Raise and lock the siderails in the highest height position (*Raising the siderails* (page 29)).
7. Release the brakes (*Applying or releasing the brakes* (page 21)).
8. Raise the **Zoom** handles to the upright position (*Raising or lowering the Zoom handles option* (page 25)).
9. Adjust bed height.
10. Grasp and hold both handles (Figure 12).

Note

- The throttle indicator will flash green when it senses your hand on the handle. The throttle indicator is solid green when **Zoom** is ready.
- If you remove your hand from the throttle handle, the product will stop and **Zoom** will deactivate.

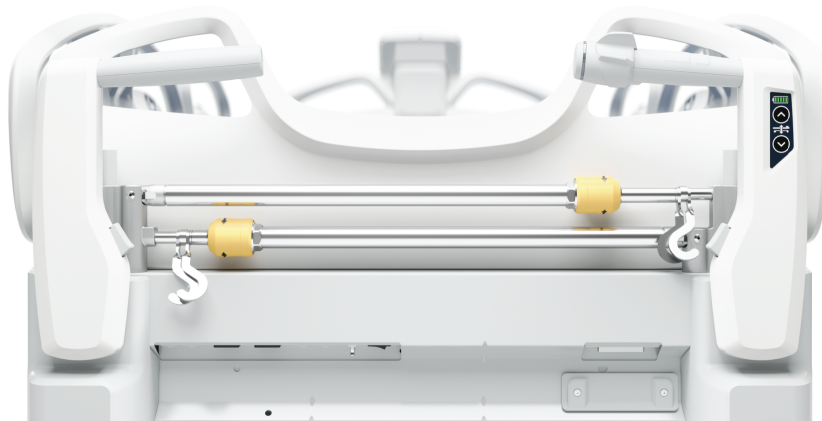

Figure 12 – Zoom handles

11. Using your thumb or index finger, rotate the throttle forward to move the product forward.

Note - Rotate the throttle to increase or decrease the **Zoom** speed.

12. Using your thumb or index finger, rotate the throttle backward to move the product backward.

Note

- If **Zoom** is inactive with the brakes applied for over 10 minutes, the **Zoom** system will enter sleep mode to preserve battery power. To exit sleep mode, release the brakes or plug the product into a wall outlet.
- If **Zoom** is inactive with the brakes released for over two hours, the **Zoom** system will enter sleep mode to preserve battery power. To exit sleep mode, apply and release the brakes or plug the product into a wall outlet.
- If **Zoom** loses power or has low battery while in drive, the **Zoom** wheel will lock in place. To allow the **Zoom** wheel to turn, press the Drive Release switch (A) located on the **Zoom** base (Figure 13).

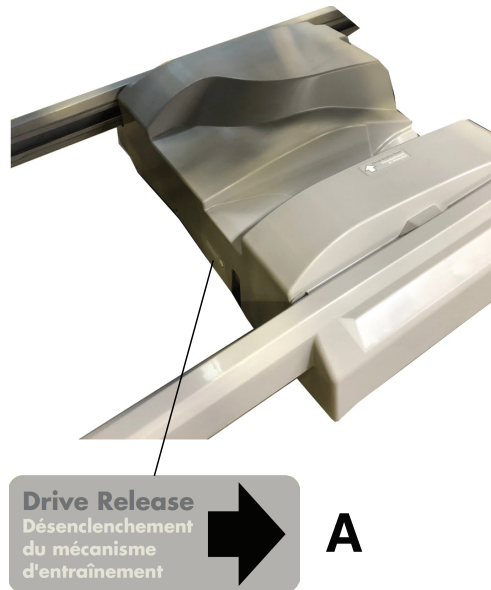

Figure 13 – Zoom Drive Release

Stopping the product with Zoom drive option

You can rotate the **Zoom** throttle to stop the product in three ways.

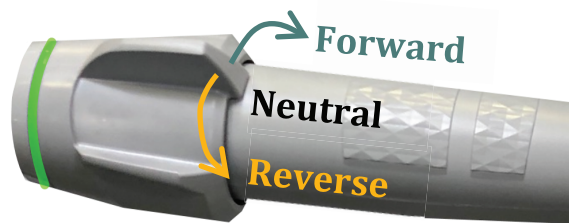

Figure 14 – Zoom throttle

Fast or normal stop	How to use
Fast stop when moving forward	Rotate the throttle past neutral to reverse. Do not let go of the handle.
Fast stop in reverse	Rotate the throttle past neutral to forward. Do not let go of the handle.
Normal stop	Rotate the throttle to neutral.

You cannot move the product with **Zoom** drive if:

- The throttle is stuck outside of neutral or
- You rotate the throttle before you grab the handle

Rotate the throttle back to neutral to resume **Zoom** drive.

Raising or lowering the Zoom handles option

The **Zoom** handles are at the head end of the product.

To raise the **Zoom** handles, lift both handles until they lock in the upright position.

Note - Put both handles in the upright and locked position to transport the product with **Zoom**.

To lower the **Zoom** handles, press the handle release (F) on the base of the handle and lower the handle (Figure 15).

Zoom drive modes

Note - Push the product in neutral. Use the headboard and siderails to move the product in the room or on/off of an elevator. Only use the throttle when you push the product in **Zoom**.

The **Zoom** throttle (A) (Figure 15) has three drive modes.

Mode	Use	How to use
Wheel up	Push the product laterally (from side to side)	<ol style="list-style-type: none">1. Release the handle to turn Zoom off.2. Use the headboard to manually push the product.
Drag	Prevent the bed from rolling away when on a ramp	Let go of the handle when driving on a ramp.
Free wheel	Allow the Zoom drive to act like a manual fifth wheel Note - You cannot move the product laterally when the Zoom drive wheel is down.	<ol style="list-style-type: none">1. Hold the handle with the product not moving for several seconds.2. Push or pull the bed with the wheel acting like a turning pivot in the middle of the product.

Zoom control panel, throttle handle option

WARNING

- Always lower the product to its lowest height when the patient is unattended to reduce the risk of injury due to patient falls.
 - Always lock the controls when the patient is unattended.
 - Always route the cables, wires, and tubing from other equipment so that parts of the product do not pinch them.
-

CAUTION - Always clear the product of obstacles before you use motion functions.

Note - The motion button flashes when the product reaches the motion limit.

If the bed battery switch is turned off, the bed height controls will not work until you plug the product back into a wall outlet and turn the bed battery switch on (*Charging the battery* (page 19)).

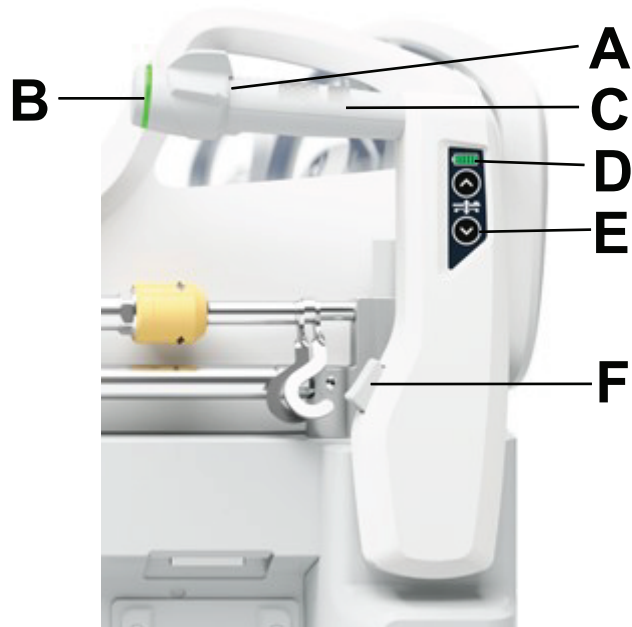

Figure 15 – Zoom throttle

A	Throttle	Rotates to move the bed	
B	Throttle indicator	Green (flashing)	Zoom is activating/deactivating
		Green (solid)	Zoom is ready
		Amber (flashing)	Error, contact service
		Off	Zoom inactive
C	Touch sensor	Lowers the wheel to the floor when activated by your hand	
D	Zoom battery level	Green (solid)	All Zoom functions available
		Green (flashing)	Charging
		Red (solid)	Low battery. All Zoom functions available, reduced speed on ramps Note - If Zoom is inactive, wheel will not deploy.
		Red (flashing)	Very low battery, deactivate Zoom and transport product manually
E	Bed height controls	Raises and lowers the litter	
F	Handle release	Lowers the Zoom handles	

Activating the CPR release handle

CAUTION - Always confirm that all persons and equipment are away from the area below and around the Fowler before you activate the CPR release handle. The CPR release handle is for emergency use only.

Note - For products equipped with the **Isolibrium** PE support surface option, see the **Isolibrium** PE support surface Operations Manual for additional CPR instructions.

When you raise the Fowler and need quick access to the patient, pull the CPR release handle to position the product to 0 degrees.

The two CPR release handles are on the left and right side of the litter Gatch section (A) (Figure 16).

To pull the CPR release handle:

1. Pull the handle (A) on the left or right side of the litter Gatch section (Figure 16).

Note - Release the CPR release handle at any time to stop product Fowler, Gatch, and foot section motion.

2. Guide the Fowler to the flat position.



Figure 16 – Activating the CPR release handle

Removing or replacing the headboard

WARNING - Do not use the headboard for CPR support.

You can remove the headboard (A) (*Product illustration* (page 13)) to access the patient or to clean the product.

To remove the headboard, grasp the handles and lift the headboard straight up and off the product.

To replace the headboard:

1. Align the headboard pegs with the sockets at the head end of the product.
2. Lower the headboard until the headboard seats into the sockets.

Removing or replacing the footboard

You can remove the footboard (G) (*Product illustration* (page 13)) to access the patient or to clean the product.

To remove the footboard, grasp the handles and lift the footboard straight up and off the product.

To replace the footboard:

1. Align the footboard pegs with the sockets at the foot end of the product.

2. Lower the footboard until the footboard seats into the sockets.

Raising the siderails

WARNING

- Always set the siderail position for appropriate patient safety.
 - Always lock the controls when the patient is unattended.
 - Always route the cables, wires, and tubing from other equipment so that parts of the product do not pinch them.
-

Note - Do not use siderails as a patient restraint device.

When you raise the siderails, listen for a click to indicate that the siderail locks into position. Pull on the siderail to make sure the siderail locks.

- To raise the siderail to the highest position, press and hold the siderail release (N) (*Product illustration* (page 13)) and rotate the siderail up from either the lowest position or intermediate position (Figure 17).

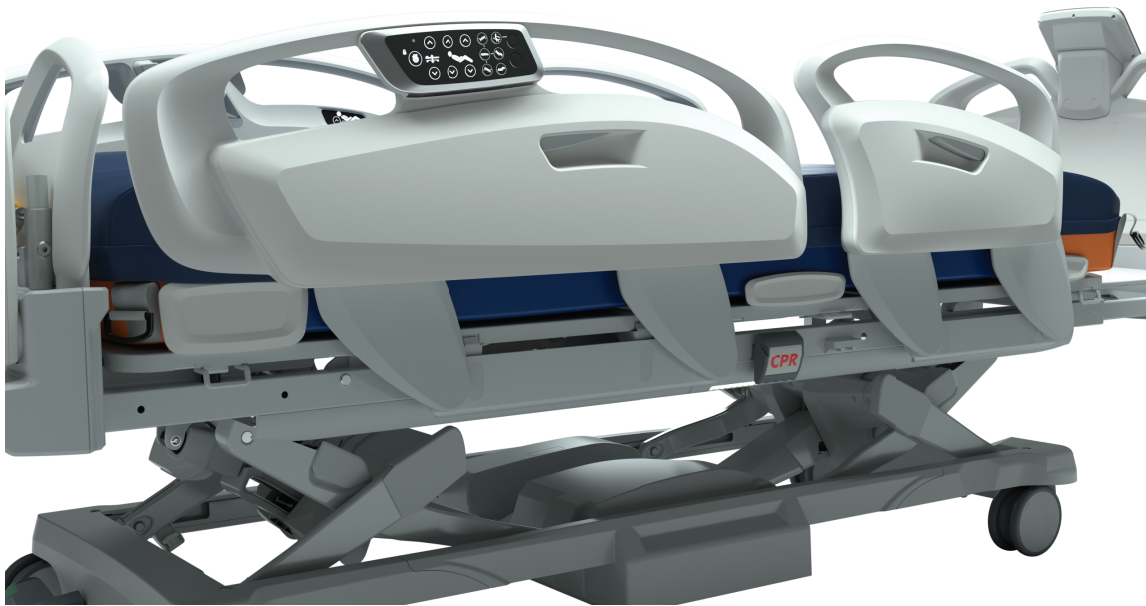

Figure 17 – Siderail highest position

- To raise the siderail to the intermediate position, grasp and rotate the siderail up from the lowest position until you hear the siderail click (Figure 18).

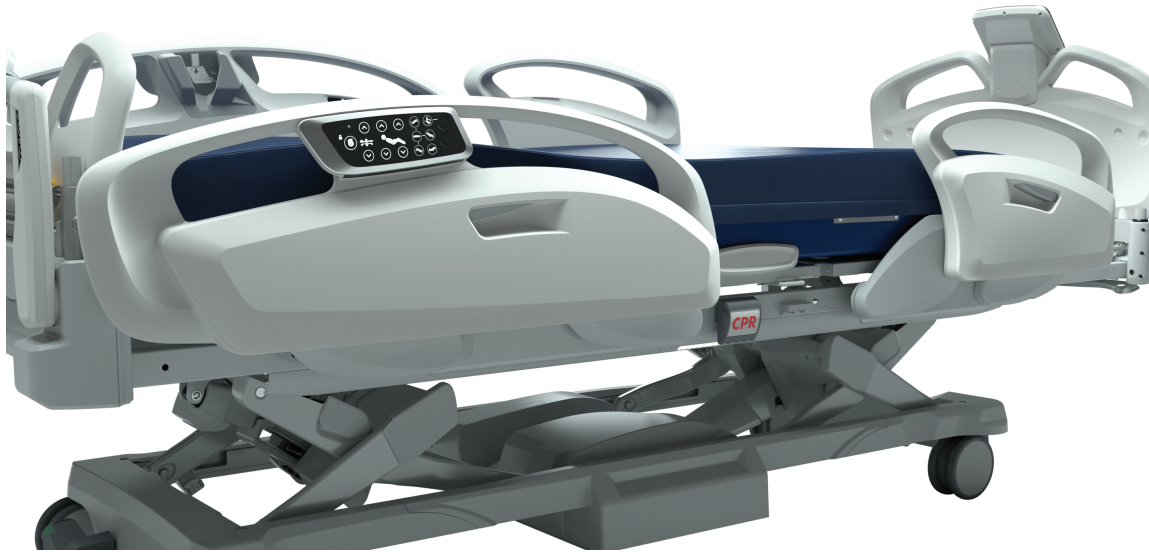

Figure 18 – Siderail intermediate position

Lowering the siderails

WARNING

- Always set the siderail position for appropriate patient safety.
 - Always lock the controls when the patient is unattended.
 - Always route the cables, wires, and tubing from other equipment so that parts of the product do not pinch them.
-

Note - Do not use siderails as a patient restraint device.

When you lower the siderails, listen for a click to indicate that the siderail locks into position. Pull on the siderail to make sure the siderail locks.

- To lower the siderail to the intermediate position, press the siderail release (N) (*Product illustration* (page 13)) and rotate the siderail forward until the siderail stops at the intermediate position (Figure 18).
- To lower the siderail to its lowest position, press and hold the siderail release and rotate the siderail to the lowest position (Figure 19).

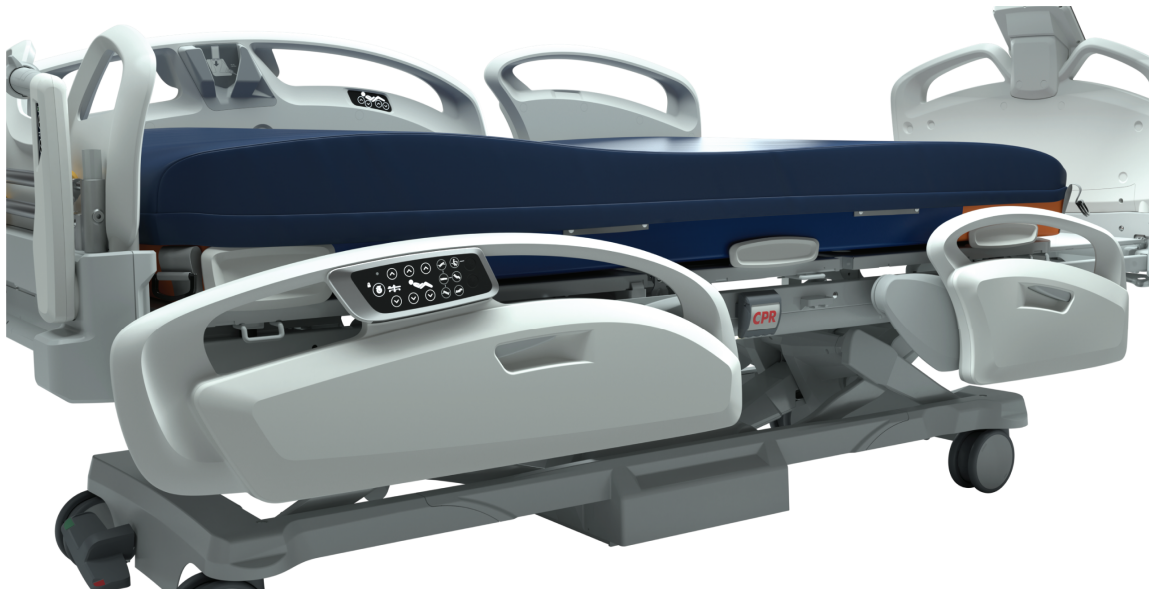

Figure 19 – Siderail lowest position

Extending or retracting the bed extender

The bed extender allows you to extend the length of the product by 12 in. (30.5 cm).

To extend the bed extender:

1. Grasp and squeeze the bed extender release handle (R) (*Product illustration* (page 13)).
2. Continue to squeeze the bed extender release handle and pull to extend the bed extender until it stops.
3. Release the bed extender release handle to lock the bed extender in place.

Note - Push and pull on the footboard to confirm that the bed extender is locked.

4. Place the foot extender mattress (*Accessories and parts* (page 64)) onto the bed extender.

To retract the bed extender:

1. Remove the foot extender mattress (*Accessories and parts* (page 64)) from the bed extender.
2. Grasp and squeeze the bed extender release handle (R) (*Product illustration* (page 13)).
3. Continue to squeeze the bed extender release handle and push to retract the bed extender until it stops.
4. Release the bed extender release handle to lock the bed extender in place.

Note - Push and pull on the footboard to confirm that the bed extender is locked.

Securing patient restraint straps

There are eight patient restraint strap tie-in locations on the litter assembly to secure patient restraint straps. Two are located on the Fowler section, four are located on the Gatch section, and two are located on the foot section (Figure 20).

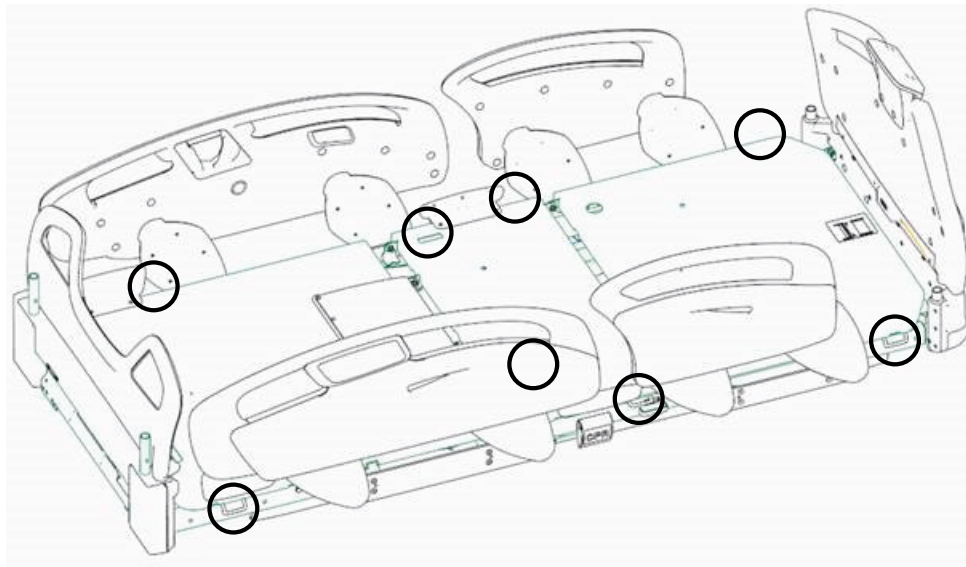

Figure 20 – Restraint strap tie-in locations

Securing a Foley bag to the Foley bag hook

There are two Foley bag hooks under the foot section (A) (Figure 21), one on either side of the product.

To secure a Foley bag, place the hook of the Foley bag on the Foley bag hook.

Note

- The safe working load of the Foley bag hook is 10 lb (4.5 kg).
- Do not allow the Foley bag to touch the ground while the product is in low height.



Figure 21 – Foley bag hook

Activating nurse call

Nurse call allows the patient or healthcare professional to send a signal to the nurse station for assistance.

To activate nurse call, press the **Nurse call** button (B) (*Operator control panel, basic, outside siderail* (page 38), *Operator control panel, advanced, outside siderail option* (page 39)) (A) (*Patient control panel, inside siderail* (page 40)).

Note - Nurse call requires a connection between the product and an applicable input (patient station, head wall, or docker station). See *Setting up wired nurse call communication* (page 16).

Connecting peripheral equipment to the auxiliary outlet

WARNING

- Only use hospital grade electric equipment consuming 5A or less with the auxiliary outlet. The use of standard electric equipment may bring the current leakage to a level unacceptable for hospital equipment.
 - Do not use the auxiliary outlet for life sustaining equipment.
-

The auxiliary outlet is a built-in outlet for peripheral equipment. The auxiliary outlet (J) is at the foot end of the product (*Product illustration* (page 13)).

Note - Resettable circuit breakers at the head end of the product protect the auxiliary outlet.

Connecting a patient device to the USB port option

Note - The USB port is designed to accommodate devices that comply with the appropriate standards (i.e. IEC 60601-1, IEC 60950) and rated for a maximum of 5Vdc.

The USB port is a built-in port for patient devices. The USB port is located in the patient device holder (C) on the patient left siderail (*Product illustration* (page 13)).

Isolibrium PE support surface option

The **Isolibrium** PE is a powered support surface with features that provide pressure redistribution, low air loss, turn assist, max inflate, and lateral rotation.

Note - See the **Isolibrium** PE support surface Operations Manual for connection instructions.

When the **Isolibrium** PE support surface is connected to **ProCuity**, active functions are displayed at the top of the **Home** screen (*Footboard control panel, advanced - Home option* (page 45)).

The function screens available to the healthcare professional include:

- **Pressure** (*Footboard control panel, advanced - Pressure option* (page 34))
- **Turn** (*Footboard control panel, advanced - Turn option* (page 35))
- **Pulmonary** (*Footboard control panel, advanced - Pulmonary option* (page 37))

Preparing Isolibrium PE for a new patient option

WARNING - Do not load **Isolibrium** PE above the safe working load of 460 lb (208.6 kg).

To prepare **Isolibrium** PE for a new patient:

1. Before you place a patient on the product, zero/tare the scale (*Zeroing/taring the scale, advanced option* (page 52)).
2. Position the patient on the product.

Note - See the **Isolibrium** PE support surface Operations Manual for positioning instructions.

3. Weigh and save the patient weight (*Weighing a patient, advanced option* (page 52)).

Note - When you save the patient weight, the **Patient Weight Range** (J) will automatically set. You can still manually adjust the **Patient Weight Range** (J) on the **Pressure** screen (*Footboard control panel, advanced - Pressure option* (page 34)).

Preparing bed positions for Isolibrium PE functions option

WARNING - Always route the cables, wires, and tubing from other equipment so that parts of the product do not pinch them during operation.

CAUTION - Always clear the product of obstacles before you use motion functions.

To prepare bed positions:

1. Lock the siderail control panel functions (*Footboard control panel, advanced - Motion lock option (page 48)*).
2. Raise and lock the siderails in the highest height position (*Raising the siderails (page 29)*).
3. Lower the bed height to the lowest practical position (*Footboard control panel, advanced - Home option (page 45)*).
4. Lower the Fowler section to the flat position or as low as possible (*Footboard control panel, advanced - Home option (page 45)*).

Footboard control panel, advanced - Pressure option

The **Pressure** screen displays the pressure functions of the product.

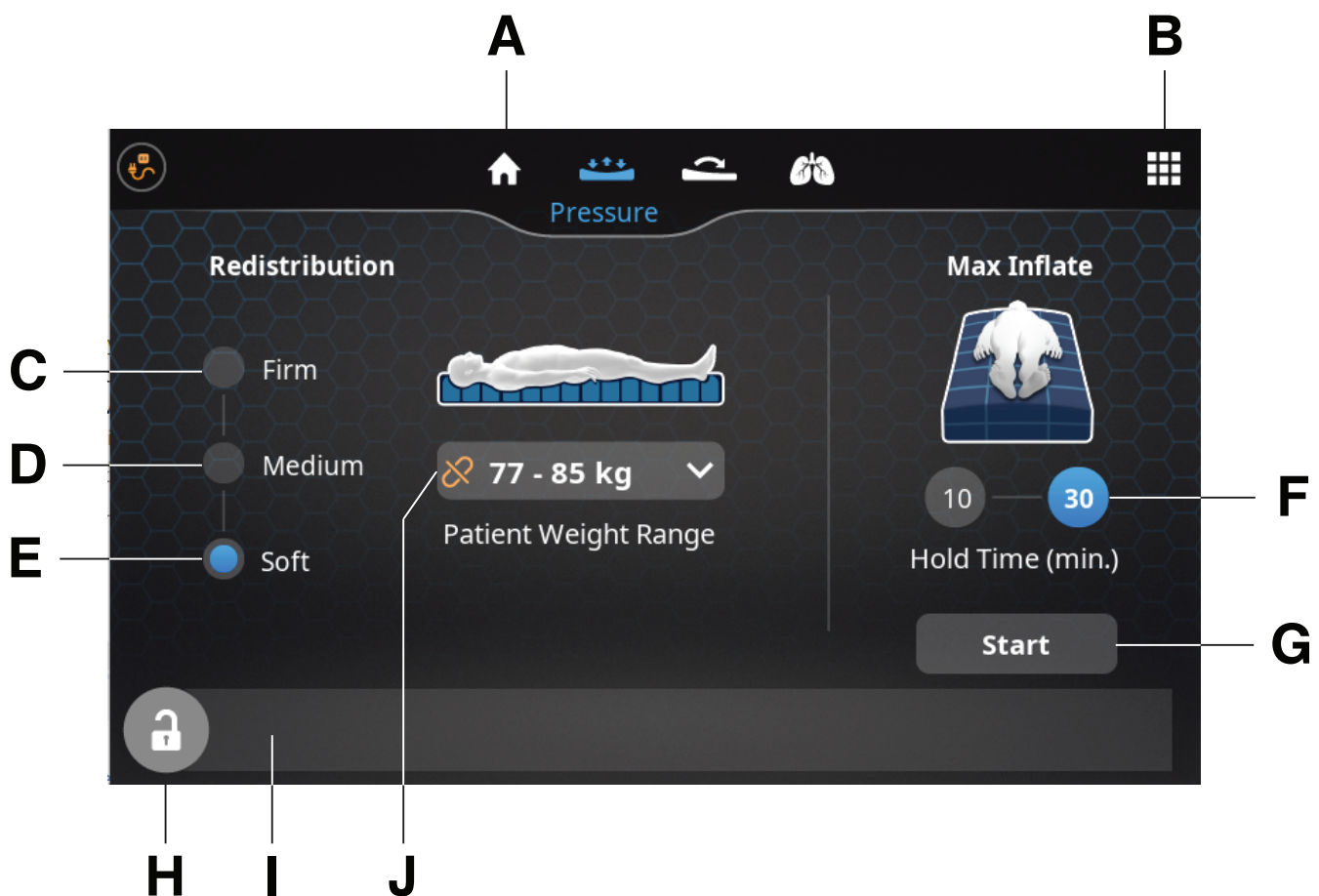

A	Home	Returns to the Home screen (<i>Footboard control panel, advanced - Home option (page 45)</i>)
B	Menu	Displays menu functions (<i>Footboard control panel, advanced - Menu option (page 60)</i>)
C	Firm	Select to increase the redistribution firmness setting

D	Medium	Default redistribution firmness setting
E	Soft	Select to decrease the redistribution firmness setting
F	Hold time	Select 10 minutes or 30 minutes for the max inflate hold time
G	Start	Starts selected max inflate hold time
H	Lock	Locks or unlocks selected mattress operation settings
I	Status bar	Displays current mattress status
J	Patient weight range	Select to choose the current patient weight range

Activating pressure redistribution option

Pressure redistribution provides firmness for the patient based on the weight range and firmness settings.

To activate pressure redistribution:

1. On the **Home** screen, press the **Pressure** button (A) (*Footboard control panel, advanced - Home option (page 45)*).
2. On the **Pressure** screen, select from the following redistribution options:
 - Soft (E) (*Footboard control panel, advanced - Pressure option (page 34)*)
 - Medium (D) (*Footboard control panel, advanced - Pressure option (page 34)*)
 - Firm (C) (*Footboard control panel, advanced - Pressure option (page 34)*)

Activating max inflate option

To activate max inflate:

1. On the **Home** screen, press the **Pressure** button (A) (*Footboard control panel, advanced - Home option (page 45)*).
2. On the **Pressure** screen, select the 10 minute or 30 minute hold time (F) (*Footboard control panel, advanced - Pressure option (page 34)*).
3. Press the **Start** button (G) to start max inflate (*Footboard control panel, advanced - Pressure option (page 34)*).

To cancel or stop max inflate, press the button in the status bar (I) when it appears (*Footboard control panel, advanced - Pressure option (page 34)*).

Footboard control panel, advanced - Turn option

The **Turn** screen displays the turn functions of the product.

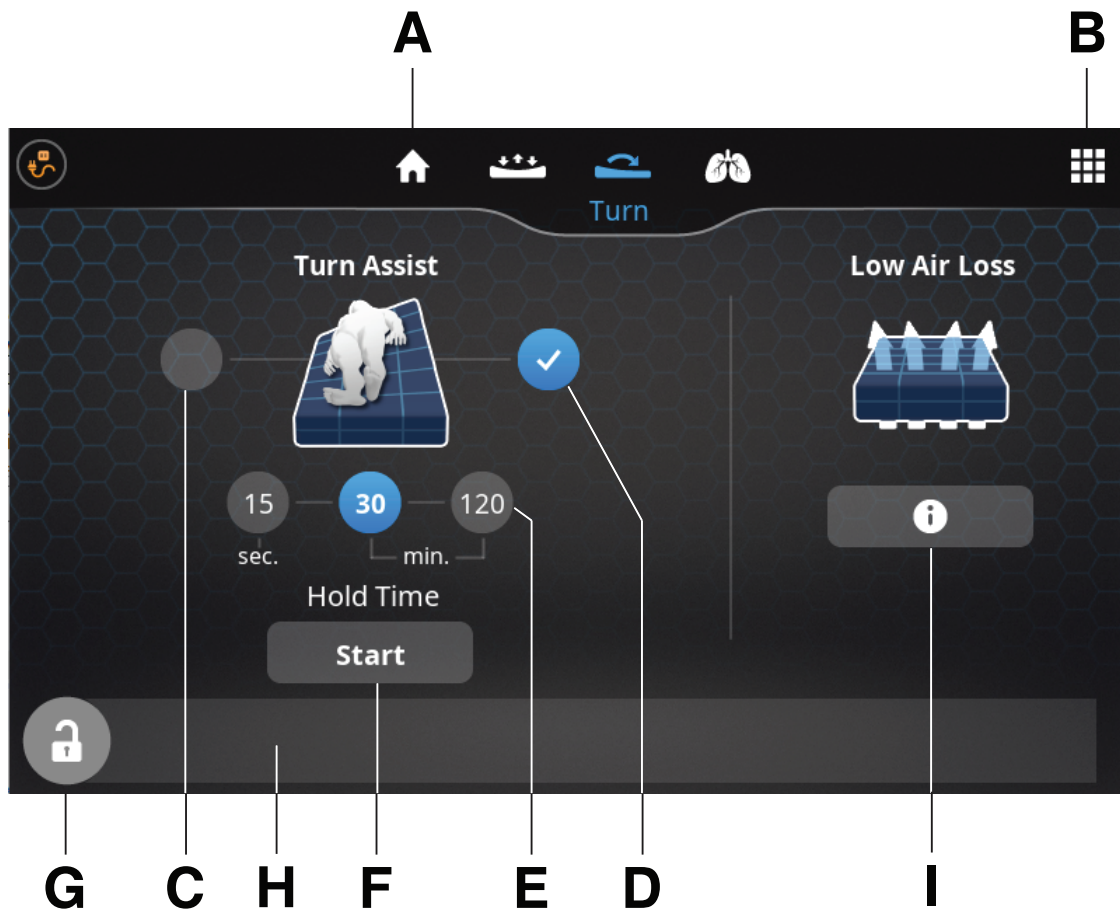

A	Home	Returns to the Home screen (<i>Footboard control panel, advanced - Home option (page 45)</i>)
B	Menu	Displays menu functions (<i>Footboard control panel, advanced - Menu option (page 60)</i>)
C	Turn assist, patient right	Selects turn assist for the patient right side
D	Turn assist, patient left	Selects turn assist for the patient left side
E	Hold time	Select 15 seconds, 30 minutes, or 120 minutes for the turn assist hold time
F	Start	Starts selected turn assist hold time
G	Lock	Locks or unlocks selected mattress operation settings
H	Status bar	Displays current mattress status
I	Info	Displays the low air loss info screen

Activating turn assist option

WARNING

- Always route the cables, wires, and tubing from other equipment so that parts of the product do not pinch them during operation.
- Always lock the siderails in the highest height position during operation.
- Do not leave the patient unattended during operation.
- Do not zero the scale or weigh the patient during operation.

Note - The Fowler angle must be less than or equal to 60° for turn assist to operate.

To activate turn assist:

1. Position the patient on the center of the product.
2. Raise and lock the siderails in the highest height position (*Raising the siderails* (page 29)).
3. On the **Home** screen, press the **Turn** button (B) (*Footboard control panel, advanced - Home option* (page 45)).
4. On the **Turn** screen, select the turn assist side (C, D) (*Footboard control panel, advanced - Turn option* (page 35)).
5. Select the 15 seconds, 30 minutes, or 120 minutes hold time (E) (*Footboard control panel, advanced - Turn option* (page 35)).
6. Press the **Start** button (F) to start turn assist (*Footboard control panel, advanced - Turn option* (page 35)).

To cancel or stop turn assist, press the button in the status bar (H) when it appears (*Footboard control panel, advanced - Turn option* (page 35)).

Footboard control panel, advanced - Pulmonary option

The **Pulmonary** screen displays the pulmonary functions of the product.

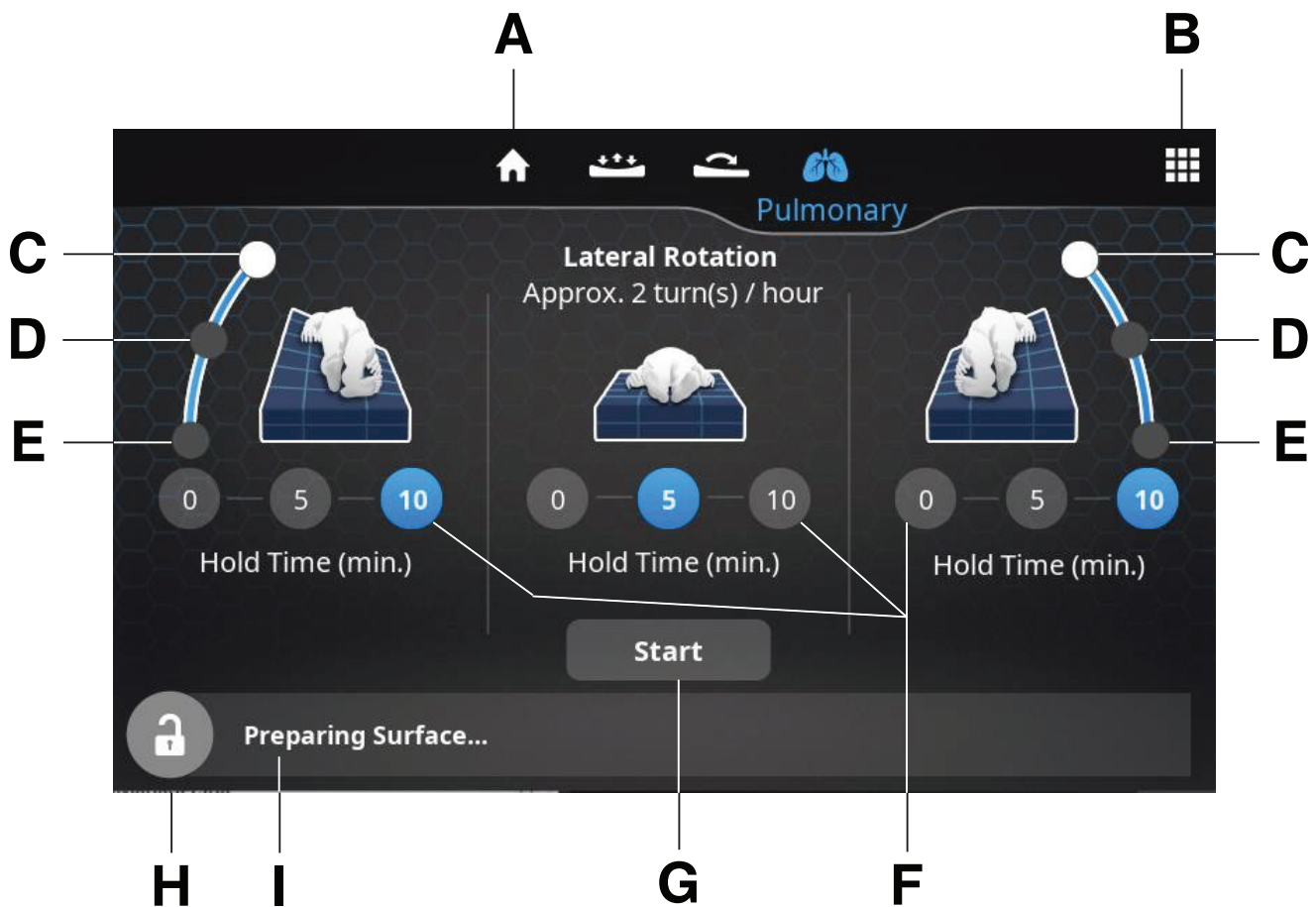

A	Home	Returns to the Home screen (<i>Footboard control panel, advanced - Home option</i> (page 45))
B	Menu	Displays menu functions (<i>Footboard control panel, advanced - Menu option</i> (page 60))
C	Full	Full rotation. Available when Fowler angle is -5° to 35°
D	Reduced	Reduced rotation. Available when Fowler angle is -5° to 60°

E	Flat	No rotation
F	Hold time	Select 0, 5, or 10 minutes for the hold time
G	Start	Starts selected lateral rotation operation
H	Lock	Locks or unlocks selected mattress operation settings
I	Status bar	Displays current mattress status

Activating lateral rotation option

Lateral rotation allows the healthcare professional to rotate the patient from left to right by increasing or decreasing the rotation levels and hold times.

WARNING

- Always route the cables, wires, and tubing from other equipment so that parts of the product do not pinch them during operation.
 - Do not extubate or intubate the patient during operation.
 - Always lock the siderails in the highest height position during operation.
 - Do not zero the scale or weigh the patient during operation.
 - Always center the patient on the support surface and check frequently to maintain proper position.
-

Note

- A healthcare professional should determine the use of lateral rotation outside of the weight range of 60 lb (27.2 kg) to 460 lb (208.6 kg).
- Lateral rotation will not operate if the siderails are down.

To activate lateral rotation:

1. Position the patient on the center of the product.
2. Raise and lock the siderails in the highest height position (*Raising the siderails (page 29)*).
3. Lower the bed height to the lowest position (*Footboard control panel, advanced - Home option (page 45)*).
4. Set the Fowler angle for lateral rotation.
 - Full rotation (C): -5° to 35° (*Footboard control panel, advanced - Pulmonary option (page 37)*)
 - Reduced rotation (D): -5° to 60° (*Footboard control panel, advanced - Pulmonary option (page 37)*)
5. On the **Home** screen, press the **Pulmonary** button (C) (*Footboard control panel, advanced - Home option (page 45)*).
6. On the **Pulmonary** screen, select the rotation level (C, D, E) for the patient left and patient right side (*Footboard control panel, advanced - Pulmonary option (page 37)*).
7. Select the 0, 5, or 10 minute hold time (F) for each step.
8. Press the **Start** button (G) to start lateral rotation.

Note - Lateral rotation stops automatically when you reach 100 hours.

To pause or stop lateral rotation, press the button in the status bar (I) when it appears (*Footboard control panel, advanced - Pulmonary option (page 37)*).

Note - You can only change lateral rotation settings when the operation is stopped.

Operator control panel, basic, outside siderail

WARNING

- Always lower the product to its lowest height when the patient is unattended to reduce the risk of injury due to patient falls.
- Always lock the controls when the patient is unattended.

- Always route the cables, wires, and tubing from other equipment so that parts of the product do not pinch them.

CAUTION - Always clear the product of obstacles before you use motion functions.

Note - The motion button flashes when the product reaches the motion limit.

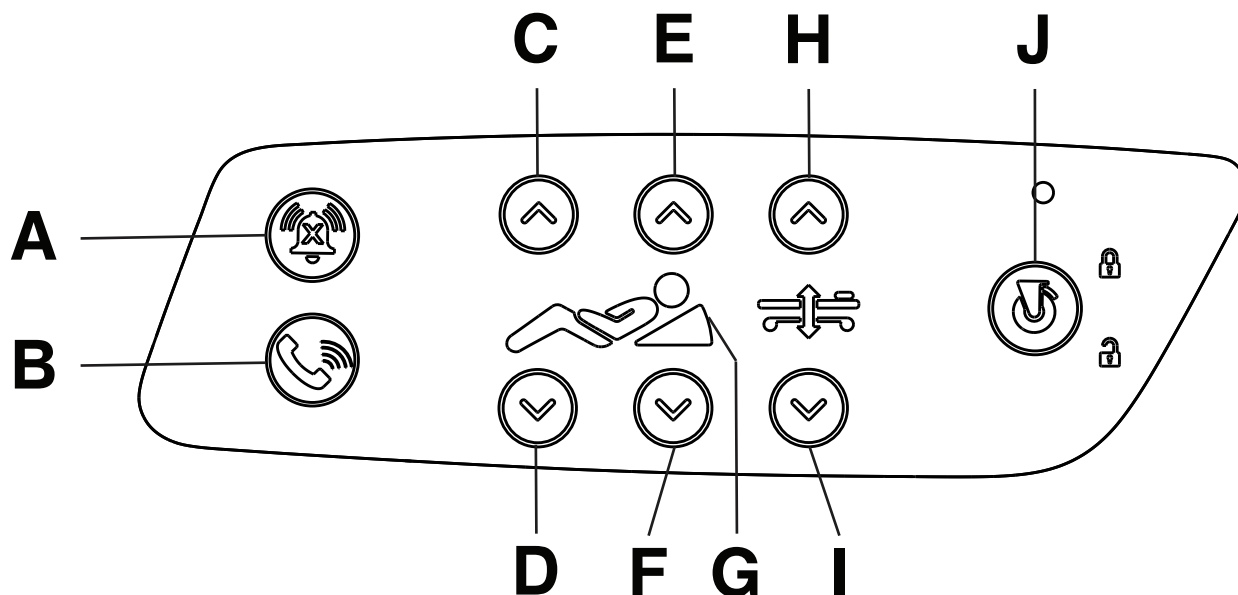

A	Bed Exit	Press and hold to cancel Bed Exit alarm
B	Nurse call	Activates nurse call
C	Gatch up	Raises the Gatch
D	Gatch down	Lowers the Gatch
E	Fowler up	Raises the Fowler
F	Fowler down	Lowers the Fowler
G	Fowler 30°+	Illuminates when the Fowler is 30°+
H	Bed height up	Raises the litter
I	Bed height down	Lowers the litter
J	Brake indicator	Illuminates when you apply or release the brake

Operator control panel, advanced, outside siderail option

WARNING

- Always lower the product to its lowest height when the patient is unattended to reduce the risk of injury due to patient falls.
- Always lock the controls when the patient is unattended.
- Always route the cables, wires, and tubing from other equipment so that parts of the product do not pinch them.

CAUTION - Always clear the product of obstacles before you use motion functions.

Note - The motion button flashes when the product reaches the motion limit.

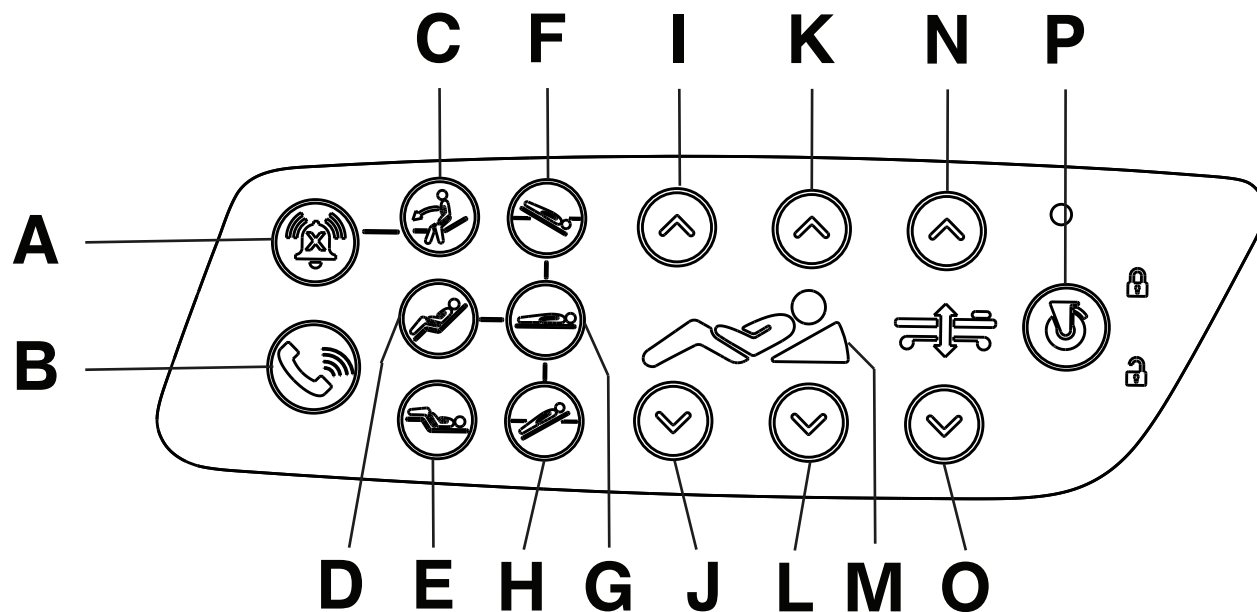

A	Bed Exit	Press and hold to cancel Bed Exit alarm
B	Nurse call	Activates nurse call
C	Patient stand assist	Places the product into a position for patient ingress or egress
D	Cardiac chair position	Places the product into the cardiac chair position
E	Vascular position	Places the product into the vascular position
F	Trendelenburg	Places the product into the Trendelenburg position (head down with foot up)
G	Bed flat	Places the product into a 0° horizontal position
H	Reverse Trendelenburg	Places the product into the Reverse Trendelenburg position (head up with foot down)
I	Gatch up	Raises the Gatch
J	Gatch down	Lowers the Gatch
K	Fowler up	Raises the Fowler
L	Fowler down	Lowers the Fowler
M	Fowler 30°+	Illuminates when the Fowler is 30°+
N	Bed height up	Raises the litter
O	Bed height down	Lowers the litter
P	Brake indicator	Illuminates when you apply or release the brake

Patient control panel, inside siderail

WARNING

- Always lower the product to its lowest height when the patient is unattended to reduce the risk of injury due to patient falls.
- Always lock the controls when the patient is unattended.

- Always route the cables, wires, and tubing from other equipment so that parts of the product do not pinch them.

CAUTION - Always clear the product of obstacles before you use motion functions.

Healthcare professionals must instruct patients how to operate the patient control panel.

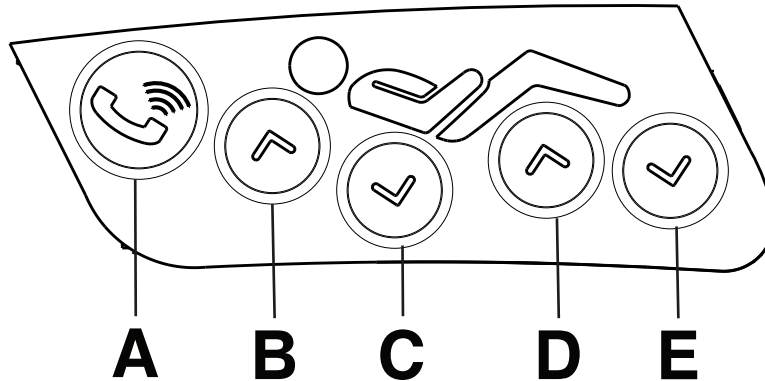

A	Nurse call	Activates nurse call
B	Fowler up	Raises the Fowler
C	Fowler down	Lowers the Fowler
D	Gatch up	Raises the Gatch
E	Gatch down	Lowers the Gatch

Pendant, basic option

WARNING

- Always lower the product to its lowest height when the patient is unattended to reduce the risk of injury due to patient falls.
- Always lock the controls when the patient is unattended.
- Always route the cables, wires, and tubing from other equipment so that parts of the product do not pinch them.

CAUTION - Always clear the product of obstacles before you use motion functions.

Healthcare professionals must instruct patients how to operate the pendant.

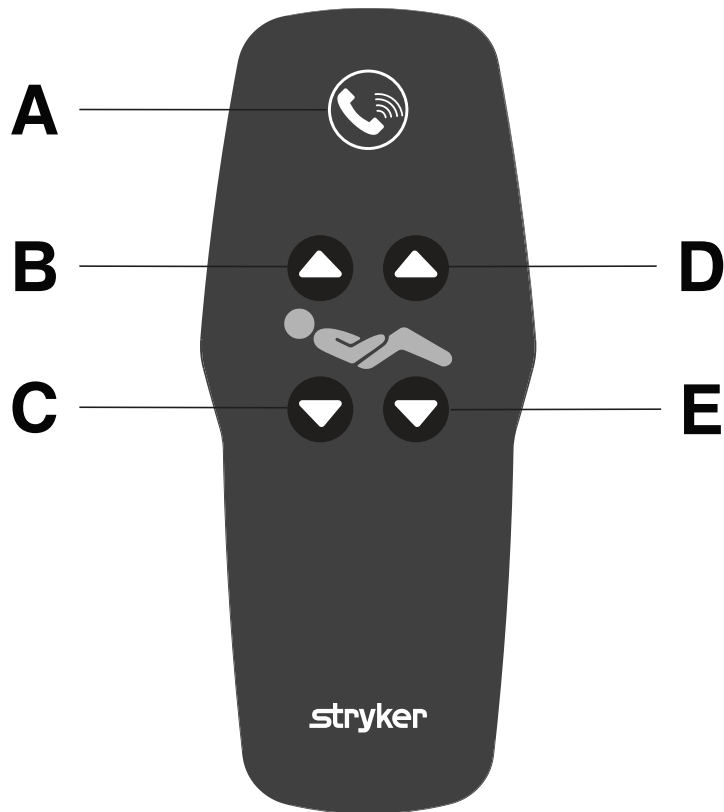

A	Nurse call	Activates nurse call
B	Fowler up	Raises the Fowler
C	Fowler down	Lowers the Fowler
D	Gatch up	Raises the Gatch
E	Gatch down	Lowers the Gatch

Pendant, advanced option

WARNING

- Always lower the product to its lowest height when the patient is unattended to reduce the risk of injury due to patient falls.
- Always lock the controls when the patient is unattended.
- Always route the cables, wires, and tubing from other equipment so that parts of the product do not pinch them.

CAUTION - Always clear the product of obstacles before you use motion functions.

Healthcare professionals must instruct patients how to operate the pendant.

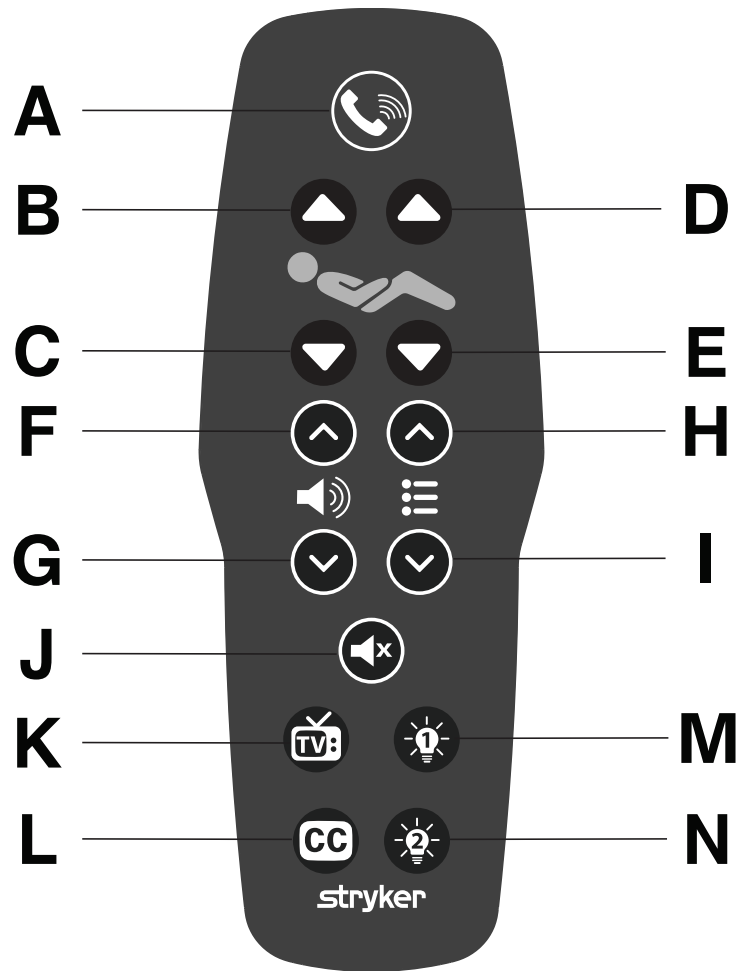

A	Nurse call	Activates nurse call
B	Fowler up	Raises the Fowler
C	Fowler down	Lowers the Fowler
D	Gatch up	Raises the Gatch
E	Gatch down	Lowers the Gatch
F	Volume up	Increases the volume
G	Volume down	Decreases the volume
H	Channel up	Changes the channel up
I	Channel down	Changes the channel down
J	Mute	Mutes the TV/radio
K	TV/radio	Turns the TV/radio on or off
L	Closed captions	Turns closed captions on or off
M	Room light	Turns the room light on or off
N	Reading light	Turns the reading light on or off

Footboard control panel - Home

The home functions are located on the touch panel of the footboard. Press the icons to display the functions of the product.

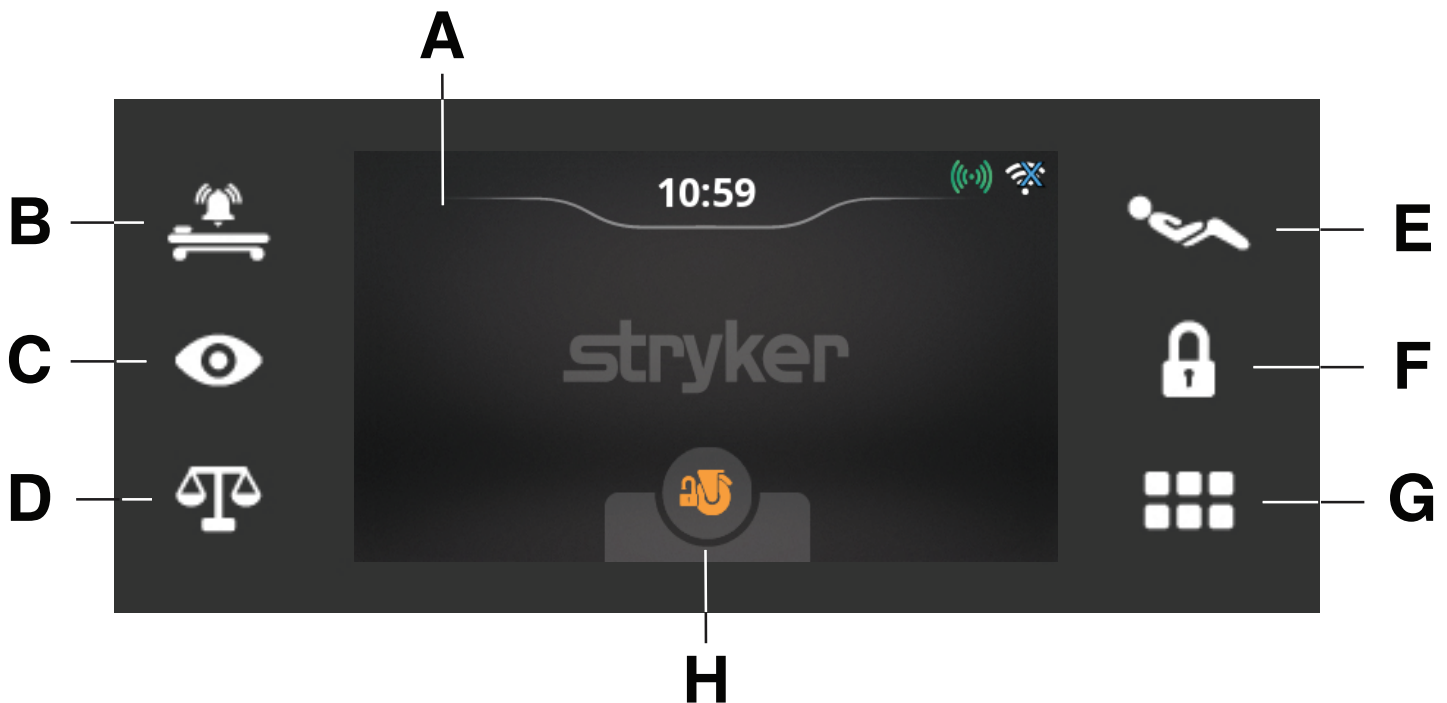

A	Screen	Displays home functions
B	Bed Exit	Activates and displays Bed Exit functions (<i>Footboard control panel - Bed Exit (page 53)</i>)
C	iBed Watch	Activates and displays iBed Watch functions (<i>Footboard control panel - iBed Watch (page 56)</i>)
D	Scale	Displays scale functions (<i>Footboard control panel - Scale (page 49)</i>)
E	Position	Displays position functions (<i>Footboard control panel - Position (page 44)</i>)
F	Motion lock	Displays lockout functions (<i>Footboard control panel - Motion lock (page 47)</i>)
G	Menu	Displays menu functions (<i>Footboard control panel - Menu (page 59)</i>)
H	Brake	Basic - Displays brake lock status Advanced option - Apply or release the brakes (<i>Applying or releasing the brakes (page 21)</i>)

Footboard control panel - Position

WARNING

- Always lower the product to its lowest height when the patient is unattended to reduce the risk of injury due to patient falls.
- Always route the cables, wires, and tubing from other equipment so that parts of the product do not pinch them.

CAUTION - Always clear the product of obstacles before you use motion functions.

The **Position** screen displays the position functions of the product.

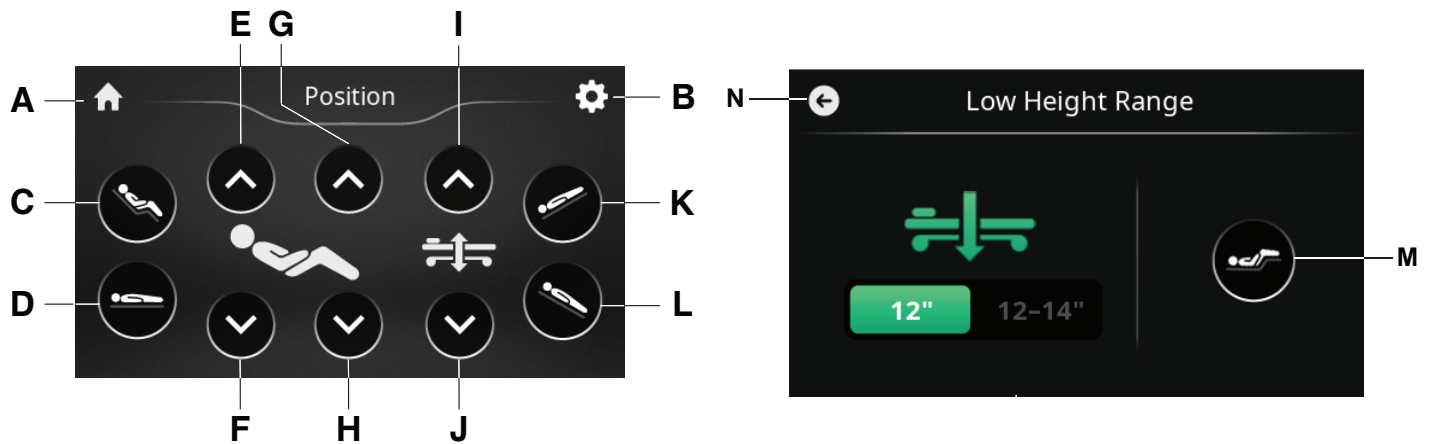

A	Home	Returns to the Home screen (see <i>Footboard control panel - Home</i> (page 44))
B	Low height range	Returns to the Low Height Range screen
C	Cardiac chair position	Places the product into the cardiac chair position
D	Bed flat	Places the product into a 0° horizontal position
E	Fowler up	Raises the Fowler
F	Fowler down	Lowers the Fowler
G	Gatch up	Raises the Gatch
H	Gatch down	Lowers the Gatch
I	Bed height up	Raises the litter
J	Bed height down	Lowers the litter
K	Trendelenburg	Places the product into the Trendelenburg position (head down with foot up)
L	Reverse Trendelenburg	Places the product into the Reverse Trendelenburg position (head up with foot down)
M	Vascular position	Places the product into the vascular position
N	Back	Returns to the Position screen

Footboard control panel, advanced - Home option

WARNING

- Always lower the product to its lowest height when the patient is unattended to reduce the risk of injury due to patient falls.
- Always route the cables, wires, and tubing from other equipment so that parts of the product do not pinch them.

CAUTION - Always clear the product of obstacles before you use motion functions.

The home functions are located on the touch panel of the footboard. Press the icons to display the functions of the product and to position the product.

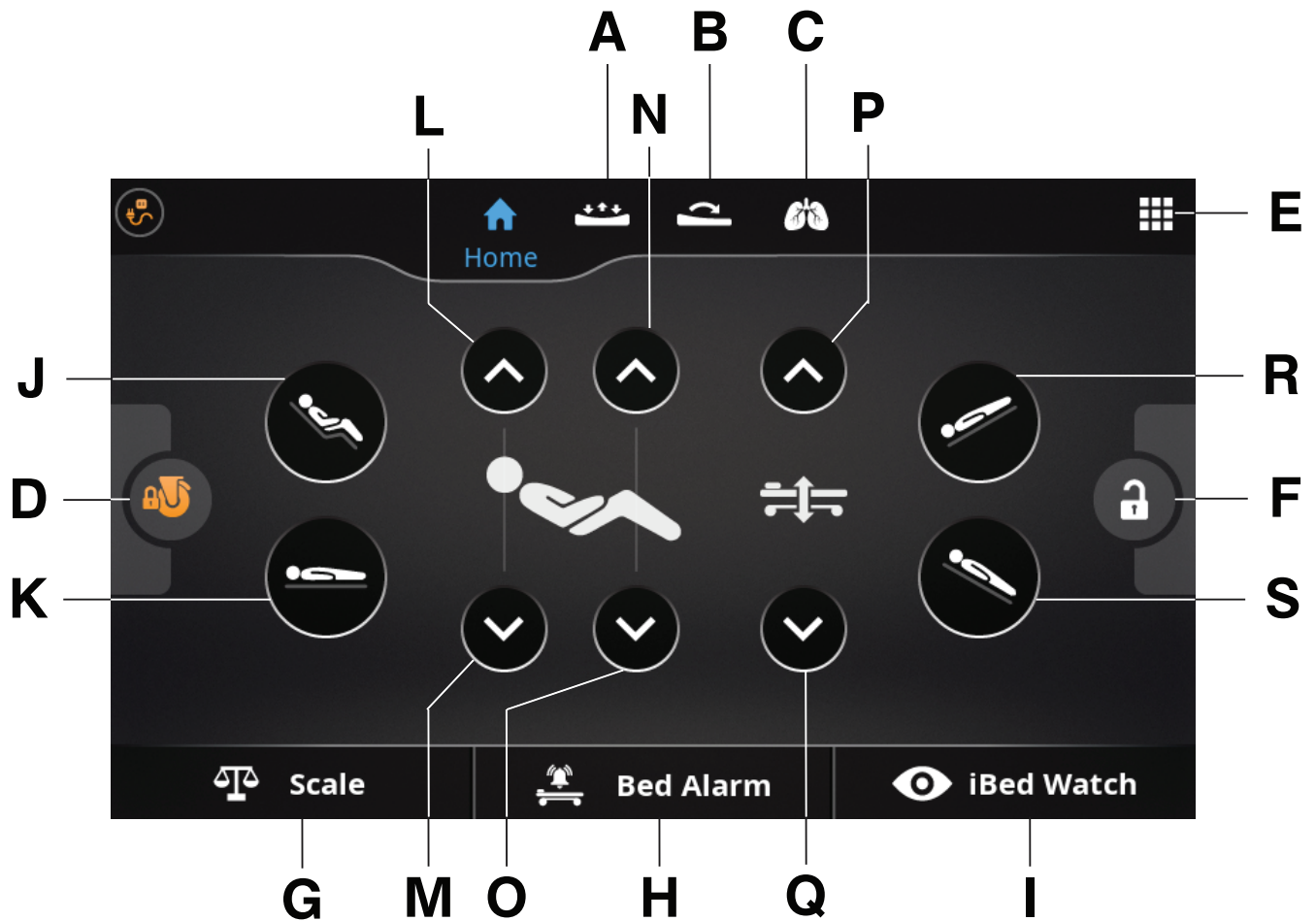

A	Pressure	Displays pressure functions option (<i>Footboard control panel, advanced - Pressure option (page 34)</i>)
B	Turn	Displays turn functions option (<i>Footboard control panel, advanced - Turn option (page 35)</i>)
C	Pulmonary	Displays pulmonary functions option (<i>Footboard control panel, advanced - Pulmonary option (page 37)</i>)
D	Brake	Basic - Displays brake lock status Advanced option - Apply or release the brakes (<i>Applying or releasing the brakes (page 21)</i>)
E	Menu	Displays menu functions (<i>Footboard control panel, advanced - Menu option (page 60)</i>)
F	Motion lock	Displays lockout functions (<i>Footboard control panel, advanced - Motion lock option (page 48)</i>)
G	Scale	Displays scale functions (<i>Footboard control panel, advanced - Scale option (page 51)</i>)
H	Bed Exit	Activates and displays Bed Exit functions (<i>Footboard control panel, advanced - Bed Exit option (page 55)</i>)
I	iBed Watch	Activates and displays iBed Watch functions (<i>Footboard control panel, advanced - iBed Watch option (page 57)</i>)
J	Cardiac chair position	Places the product into the cardiac chair position

K	Bed flat	Places the product into a 0° horizontal position
L	Fowler up	Raises the Fowler
M	Fowler down	Lowers the Fowler
N	Gatch up	Raises the Gatch
O	Gatch down	Lowers the Gatch
P	Bed height up	Raises the litter
Q	Bed height down	Lowers the litter
R	Trendelenburg	Places the product into the Trendelenburg position (head down with foot up)
S	Reverse Trendelenburg	Places the product into the Reverse Trendelenburg position (head up with foot down)

Footboard control panel - Motion lock

WARNING

- Always lock the controls when the patient is unattended.
- Always lock the controls when the patient's condition requires extra safety measures.

The **Motion Lock** screen displays the lockout functions of the product.

Lockouts can lock out motion control input from the operator control panel and patient control panel.

Note - Bed Exit, scale, and nurse call features are still available.

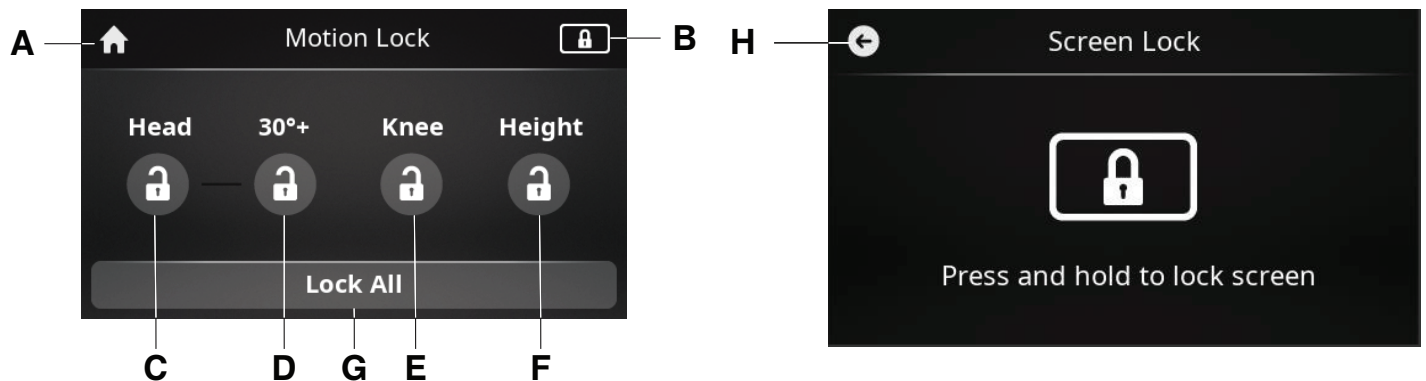

A	Home	Returns to the Home screen (<i>Footboard control panel - Home (page 44)</i>)
B	Screen lock	Returns to the Screen Lock screen
C	Head (Fowler) lock	Locks or unlocks head (Fowler) controls
D	30°+ (Fowler) lock	Locks or unlocks the head (Fowler) position to 30°+
E	Knee (Gatch) lock	Locks or unlocks knee (Gatch) controls
F	Bed height lock	Locks or unlocks bed height controls

G	Lock all	Locks or unlocks all motion function
H	Back	Returns to the Motion Lock screen

Note

- The CPR release handle overrides all lockouts.
- If the product is in a specific position when you enable a lock, the product is locked in that position.
- Lock parameters are saved when you unplug the product.
- Do not lock control panel functions if you must access control panel functions when you remove the footboard.

Footboard control panel, advanced - Motion lock option

WARNING

- Always lock the controls when the patient is unattended.
- Always lock the controls when the patient's condition requires extra safety measures.

The **Motion Lock** screen displays the lockout functions of the product.

Lockouts can lock out motion control input from the operator control panel and patient control panel.

Note - Bed Exit, scale, and nurse call features are still available.

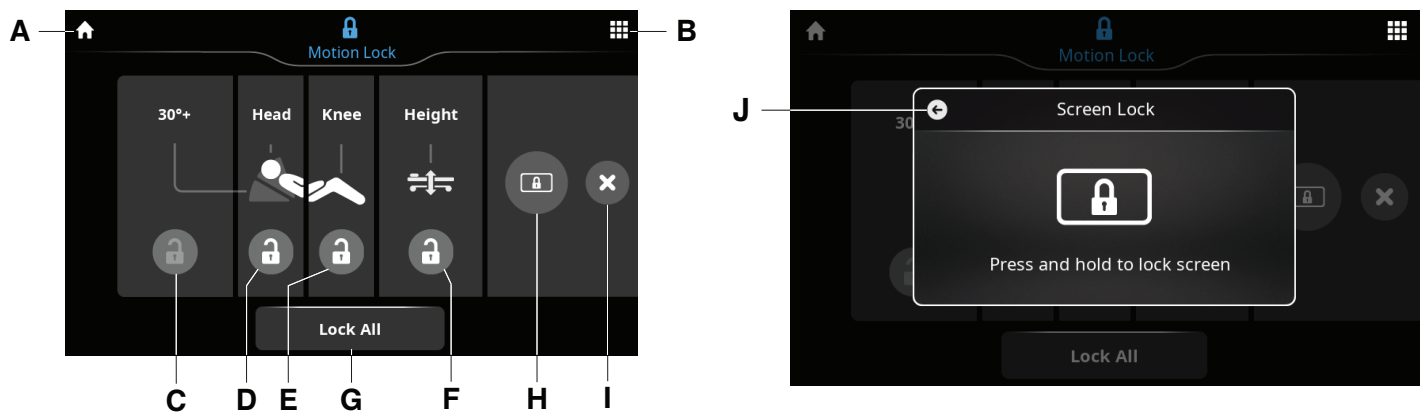

A	Home	Returns to the Home screen (<i>Footboard control panel, advanced - Home option (page 45)</i>)
B	Menu	Displays menu functions (<i>Footboard control panel, advanced - Menu option (page 60)</i>)
C	30°+ (Fowler) lock	Locks or unlocks the head (Fowler) position to 30°+
D	Head (Fowler) lock	Locks or unlocks head (Fowler) controls
E	Knee (Gatch) lock	Locks or unlocks knee (Gatch) controls
F	Bed height lock	Locks or unlocks bed height controls
G	Lock all	Locks or unlocks all motion function
H	Screen lock	Returns to the Screen Lock screen
I	Exit	Returns to the Home screen (<i>Footboard control panel, advanced - Home option (page 45)</i>)
J	Back	Returns to the Motion Lock screen

Note

- The CPR release handle overrides all lockouts.
- If the product is in a specific position when you enable a lock, the product is locked in that position.
- Lock parameters are saved when you unplug the product.
- Do not lock control panel functions if you must access control panel functions when you remove the footboard.

Footboard control panel - Scale

The **Scale** screen displays the scale functions of the product.

Note - Make sure that the product is clear of surrounding objects when scale or Bed Exit is in use.

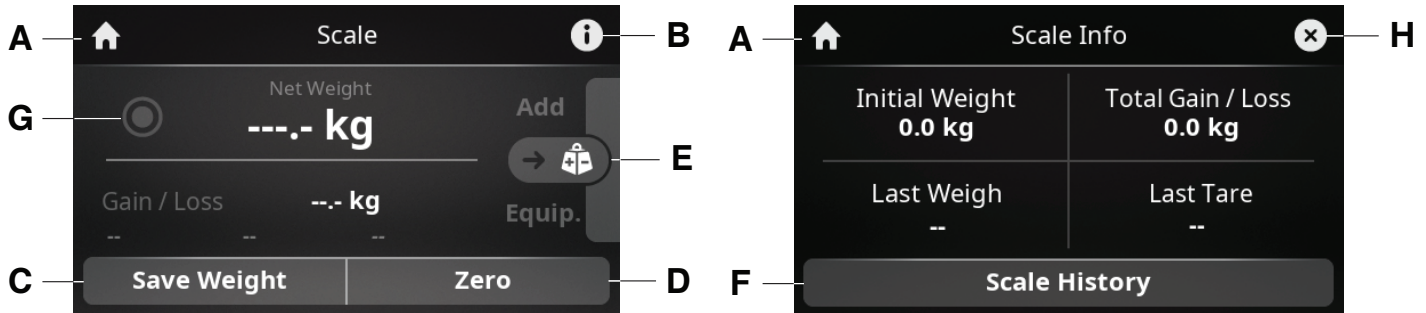

A	Home	Returns to the Home screen (<i>Footboard control panel - Home</i> (page 44))
B	Info	Displays the Scale Info screen
C	Save weight	Select to save the current displayed weight (<i>Weighing a patient</i> (page 50))
D	Zero (Non-NAWI) Tare (NAWI)	Select to zero/tare the scale or set the scale for a new patient (<i>Zeroing/taring the scale</i> (page 49))
E	Add equip.	Select to add or remove equipment (<i>Adding or removing equipment</i> (page 50)) Indicates how many items have been added to bed
F	Scale history	Displays the Scale History screen Note - The Scale History stores up to 40 scale readings.
G	Weight change indicator	Displays an up or down arrow to indicate weight change
H	Exit	Returns to the Scale screen

Zeroing/taring the scale

Before you place a patient on the product, zero/tare the scale.

Note

- **Zero** will display for non-NAWI and **Tare** will display for NAWI.
- Always zero/tare the scale after you add a support surface, mattress, or linens to the bed frame.

To zero/tare the scale:

1. Press the **Scale** button (D) on the footboard control panel (*Footboard control panel - Home* (page 44)).

2. On the **Scale** screen, press the **Zero/Tare** button (D) (*Footboard control panel - Scale* (page 49)).
3. On the **New Patient?** screen, you may choose from the following:
 - **Yes** to zero/tare and delete scale history.
 - **No** to zero/tare and not delete scale history.
 - **Cancel** to cancel zero/tare and return to the **Scale** screen.

Note - Do not touch the product when you zero/tare the scale.

Weighing a patient

WARNING - Do not use the scale system reading as a reference for medical treatment. The scale system assists only to monitor the patient's weight variation.

Before you place a patient on the product, zero/tare the scale (*Zeroing/taring the scale* (page 49)).

Note - Always zero/tare the scale after you add a support surface, mattress, or linens to the product.

To weigh a patient:

1. Press the **Scale** button (D) on the footboard control panel (*Footboard control panel - Home* (page 44)).
2. On the **Scale** screen, press the **Save Weight** button (C) (*Footboard control panel - Scale* (page 49)).

Note - Do not touch the product when you weigh the patient.

The **Scale Info** screen will display when the last weight was taken on the **Last Weigh** line (*Footboard control panel - Scale* (page 49)).

Note - The previous weight from the **Last Weigh** line will appear in **Scale History** (F) (*Footboard control panel - Scale* (page 49))

Adding or removing equipment

Note - The add or remove equipment function is only available when there is 4.4 lb (2 kg) gain/loss.

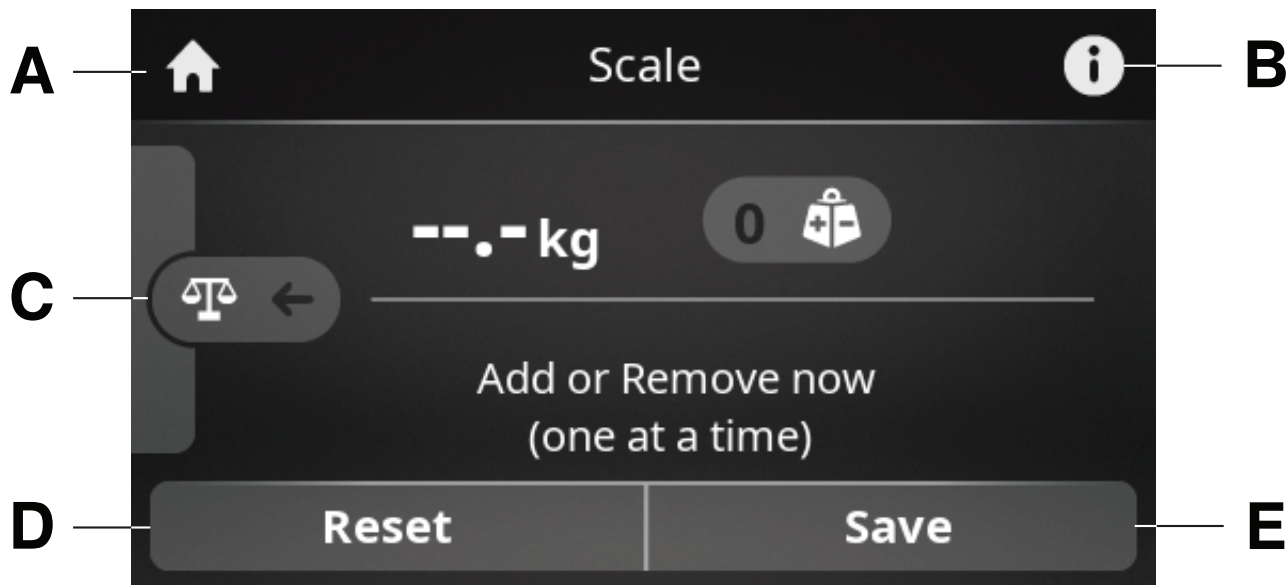

A	Home	Returns to the Home screen (<i>Footboard control panel - Home</i> (page 44))
B	Info	Displays the Scale Info screen (<i>Footboard control panel - Scale</i> (page 49))

C	Return	Returns to the Scale screen (<i>Footboard control panel - Scale (page 49)</i>)
D	Reset	Select to reset the added equipment to zero
E	Save	Select to save the current displayed weight as equipment

To add or remove equipment:

1. Press the **Scale** button (D) on the footboard control panel (*Footboard control panel - Home (page 44)*).
2. On the **Scale** screen, press the **Add Equip.** button (E) (*Footboard control panel - Scale (page 49)*).
3. One item at a time, add or remove the desired equipment from the product.

Note - Do not touch the product while the product weighs the equipment.

4. Press the **Save** button to save the current weight and equipment count.

Footboard control panel, advanced - Scale option

The **Scale** screen displays the scale functions of the product.

Note - Make sure that the product is clear of surrounding objects when scale or Bed Exit is in use.

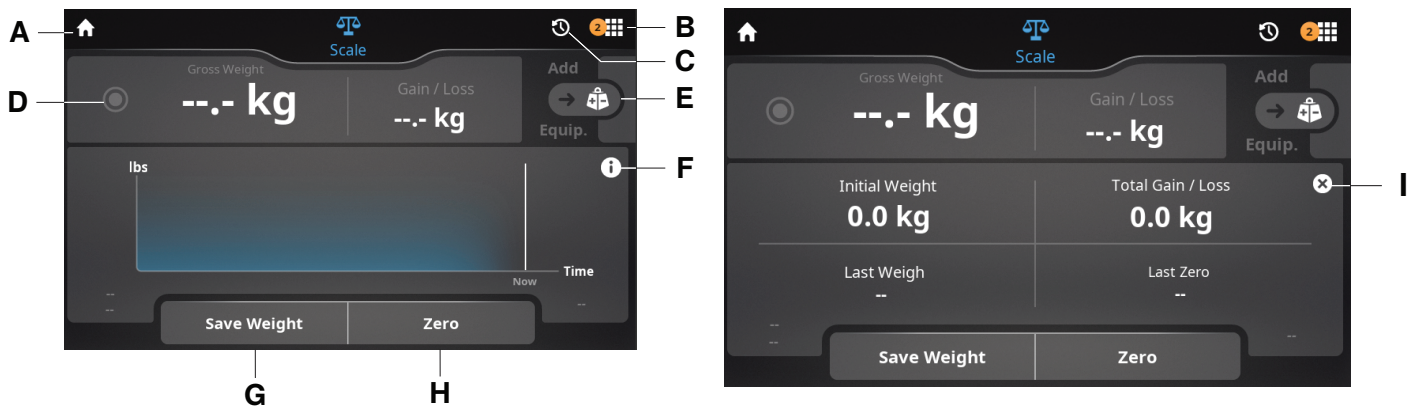

A	Home	Returns to the Home screen (<i>Footboard control panel, advanced - Home option (page 45)</i>)
B	Menu	Displays menu functions (<i>Footboard control panel, advanced - Menu option (page 60)</i>)
C	Scale history	Displays the Scale History screen Note - The Scale History stores up to 40 scale readings.
D	Weight change indicator	Displays an up or down arrow to indicate weight change
E	Add equip.	Select to add or remove equipment (<i>Adding or removing equipment, advanced option (page 52)</i>) Indicates how many items have been added to bed
F	Info	Displays the Scale Info screen
G	Save weight	Select to save the current displayed weight (<i>Weighing a patient, advanced option (page 52)</i>)

H	Zero (Non-NAWI) Tare (NAWI)	Select to zero/tare the scale or set the scale for a new patient (<i>Zeroing/taring the scale, advanced option</i> (page 52))
I	Exit	Returns to the Scale screen

Zeroing/taring the scale, advanced option

Before you place a patient on the product, zero/tare the scale.

Note

- **Zero** will display for non-NAWI and **Tare** will display for NAWI.
- Always zero/tare the scale after you add a support surface, mattress, or linens to the bed frame.

To zero/tare the scale:

1. On the **Home** screen, press the **Scale** button (G) (*Footboard control panel, advanced - Home option* (page 45)).
2. On the **Scale** screen, press the **Zero/Tare** button (H) (*Footboard control panel, advanced - Scale option* (page 51)).
3. On the **New Patient?** screen, you may choose from the following:
 - **Yes** to zero/tare and delete scale history.
 - **No** to zero/tare and not delete scale history.
 - **Cancel** to cancel zero/tare and return to the **Scale** screen.

Note - Do not touch the product when you zero/tare the scale.

Weighing a patient, advanced option

WARNING - Do not use the scale system reading as a reference for medical treatment. The scale system assists only to monitor the patient's weight variation.

Before you place a patient on the product, zero/tare the scale (*Zeroing/taring the scale, advanced option* (page 52)).

Note - Always zero/tare the scale after you add a support surface, mattress, or linens to the product.

To weigh a patient:

1. On the **Home** screen, press the **Scale** button (G) (*Footboard control panel, advanced - Home option* (page 45)).
2. On the **Scale** screen, press the **Save Weight** button (G) (*Footboard control panel, advanced - Scale option* (page 51)).

Note - Do not touch the product when you weigh the patient.

The **Scale Info** screen will display when the last weight was taken on the **Last Weigh** line (*Footboard control panel, advanced - Scale option* (page 51)).

Note - The previous weight from the **Last Weigh** line will appear in **Scale History** (C) (*Footboard control panel, advanced - Scale option* (page 51))

Adding or removing equipment, advanced option

Note - The add or remove equipment function is only available when there is 4.4 lb (2 kg) gain/loss.

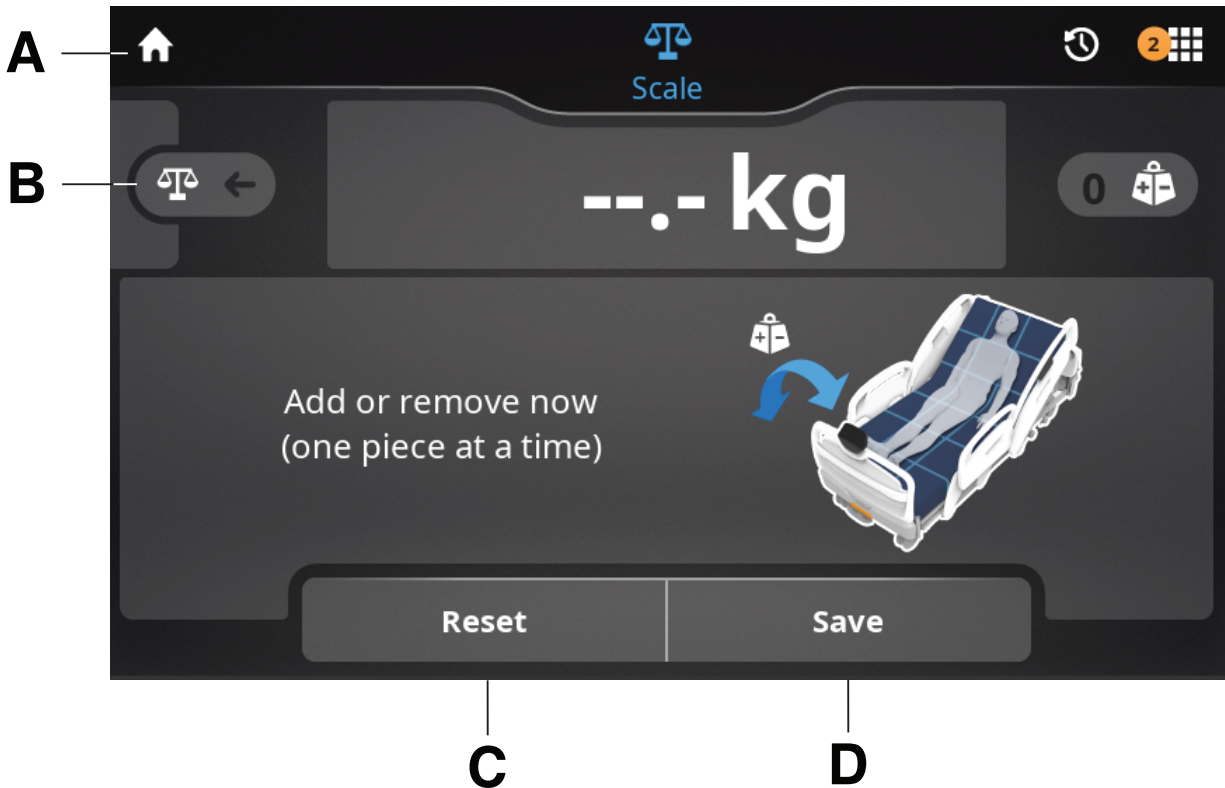

A	Home	Returns to the Home screen (<i>Footboard control panel, advanced - Home option (page 45)</i>)
B	Return	Returns to the Scale screen (<i>Footboard control panel, advanced - Scale option (page 51)</i>)
C	Reset	Select to reset the added equipment to zero
D	Save	Select to save the current displayed weight as equipment

To add or remove equipment:

1. On the **Home** screen, press the **Scale** button (G) (*Footboard control panel, advanced - Home option (page 45)*).
2. On the **Scale** screen, press the **Add Equip.** button (E) (*Footboard control panel, advanced - Scale option (page 51)*).
3. One item at a time, add or remove the desired equipment from the product.

Note - Do not touch the product while the product weighs the equipment.

4. Press the **Save** button to save the current weight and equipment count.

Footboard control panel - Bed Exit

The **Bed Exit** screen displays the Bed Exit functions of the product.

Note - Make sure that the product is clear of surrounding objects when scale or Bed Exit is in use.

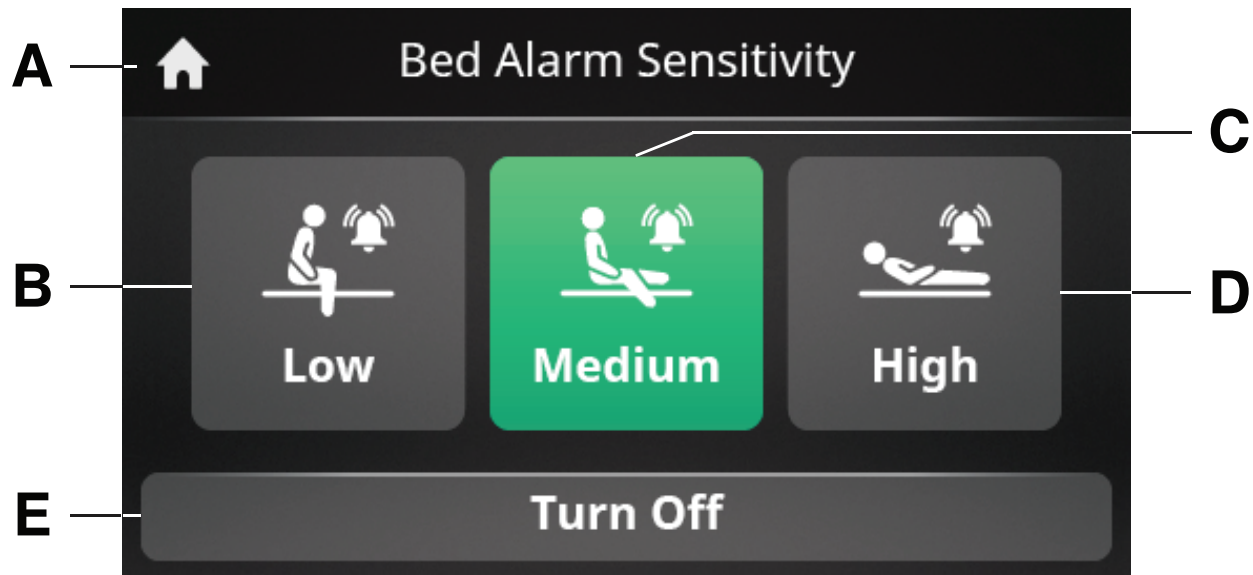

A	Home	Returns to the Home screen (<i>Footboard control panel - Home</i> (page 44))
B	Low	Allows the patient to move freely on the bed. Alarms when the patient moves 50 percent body weight out of the designated zone.
C	Medium	Allows for limited movement. Alarms when the patient approaches the siderail or the foot end of the bed.
D	High	Allows minimal movement. Alarms when the patient moves out of the tightly restricted zone.
E	Turn off	Turns off Bed Exit

Arming or disarming Bed Exit

WARNING - Do not use Bed Exit to replace patient monitoring protocol. Bed Exit is intended only to aid in the detection of a patient exiting the product.

When armed, Bed Exit monitors the patient's position on the product.

To arm Bed Exit:

1. Set the scale to zero/tare if not already performed. See *Zeroing/taring the scale* (page 49).
Note - If you do not set the scale to zero before you place a patient on the product, Bed Exit may not operate as intended.
2. Position the patient on the product.
3. Press the **Bed Exit** button (B) on the footboard control panel to arm Bed Exit (*Footboard control panel - Home* (page 44)).
4. Select the desired zone (B, C, D) (*Footboard control panel - Bed Exit* (page 53)).

If you change the parameter conditions for Bed Exit:

- Bed Exit priority signal sent (*Setting up wired nurse call communication* (page 16))
- LEDs on the footboard and siderails flash red
- Sound alarm is triggered

To disarm Bed Exit, press **Turn Off (E)** (*Footboard control panel - Bed Exit (page 53)*).

Footboard control panel, advanced - Bed Exit option

The **Bed Exit** screen displays the Bed Exit functions of the product.

Note - Make sure that the product is clear of surrounding objects when scale or Bed Exit is in use.

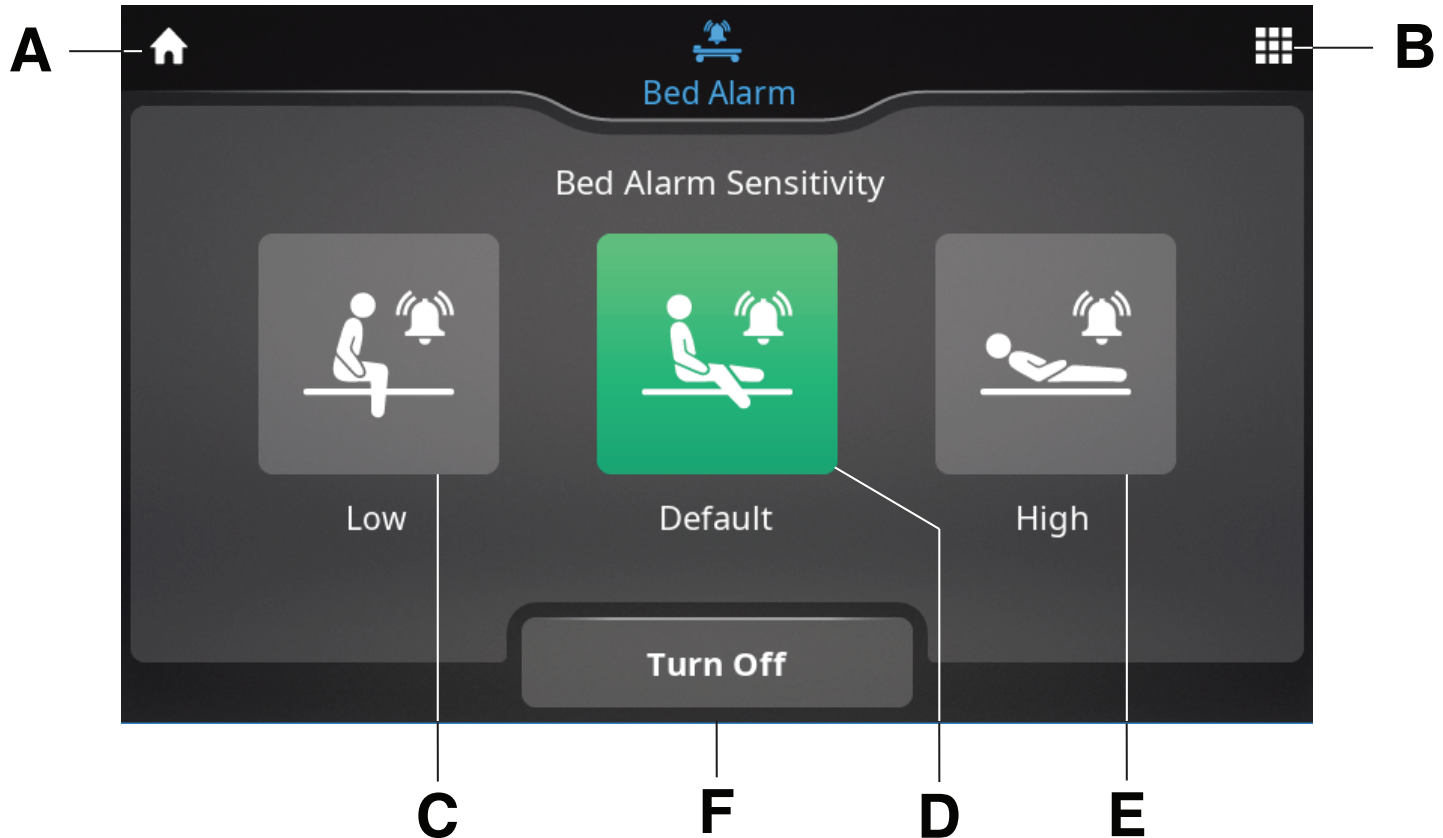

A	Home	Returns to the Home screen (<i>Footboard control panel, advanced - Home option (page 45)</i>)
B	Menu	Displays menu functions (<i>Footboard control panel, advanced - Menu option (page 60)</i>)
C	Low	Allows the patient to move freely on the bed. Alarms when the patient moves 50 percent body weight out of the designated zone.
D	Medium	Allows for limited movement. Alarms when the patient approaches the siderail or the foot end of the bed.
E	High	Allows minimal movement. Alarms when the patient moves out of the tightly restricted zone.
F	Turn off	Turns off Bed Exit

Arming or disarming Bed Exit, advanced option

WARNING - Do not use Bed Exit to replace patient monitoring protocol. Bed Exit is intended only to aid in the detection of a patient exiting the product.

When armed, Bed Exit monitors the patient's position on the product.

To arm Bed Exit:

1. Set the scale to zero/tare if not already performed. See *Zeroing/taring the scale, advanced option* (page 52)

Note - If you do not set the scale to zero before you place a patient on the product, Bed Exit may not operate as intended.

2. Position the patient on the product.

3. On the **Home** screen, press the **Bed Exit** button (H) (*Footboard control panel, advanced - Home option* (page 45)).

4. Select the desired zone (C, D, E) (*Footboard control panel, advanced - Bed Exit option* (page 55)).

If you change the parameter conditions for Bed Exit:

- Bed Exit priority signal sent (*Setting up wired nurse call communication* (page 16))
- LEDs on the footboard and siderails flash red
- Sound alarm is triggered

To disarm Bed Exit, press **Turn Off** (F) (*Footboard control panel, advanced - Bed Exit option* (page 55)).

Footboard control panel - iBed Watch

The **iBed Watch** screen displays the **iBed Watch** functions of the product.

When enabled, **iBed Watch** alerts when changes are made to the selected bed settings:

- Low height
- Siderails up
- Head angle
- Bed flat

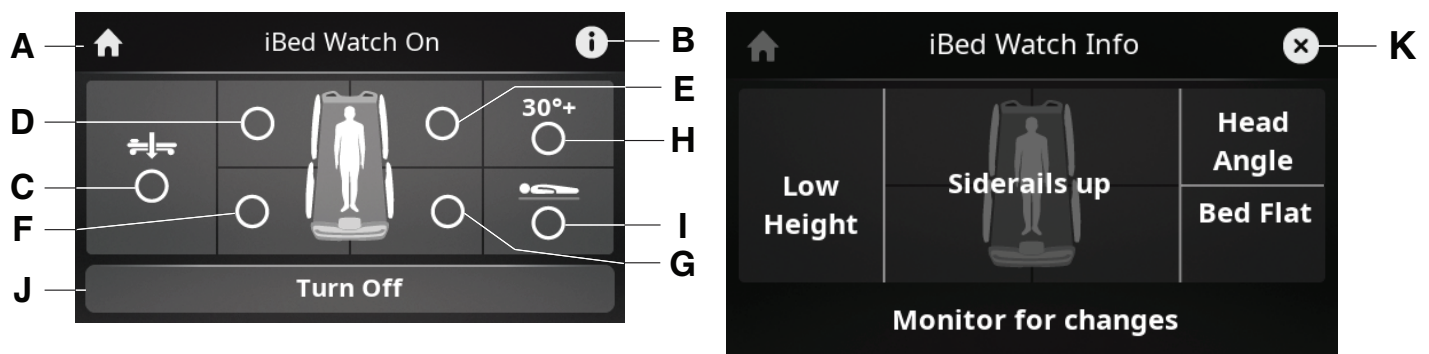

A	Home	Returns to the Home screen (<i>Footboard control panel - Home</i> (page 44))
B	Info	Displays the iBed Watch Info screen
C	Low Height	Monitors low height of the bed
D	Head right siderail	Monitors head right siderail in the highest position

E	Head left siderail	Monitors head left siderail in the highest position
F	Foot right siderail	Monitors foot right siderail in the highest position
G	Foot left siderail	Monitors foot left siderail in the highest position
H	Head Angle	Monitors head angle of the bed
I	Bed Flat	Monitors bed flat position
J	Turn Off	Turns off iBed Watch
K	Exit	Returns to the iBed Watch On screen

Enabling or disabling iBed Watch

To enable **iBed Watch**:

1. Position the patient on the product.
2. Press the **iBed Watch** button (C) on the footboard control panel (*Footboard control panel - Home* (page 44)).
3. Select the desired bed settings to monitor (*Footboard control panel - iBed Watch* (page 56)).

If you change the monitored settings for **iBed Watch**:

- Bed Exit priority signal sent (*Setting up wired nurse call communication* (page 16))
- LEDs on the footboard and siderails flash red
- Sound alarm is triggered

To disable **iBed Watch**, press **Turn Off** (J) (*Footboard control panel - iBed Watch* (page 56)).

Footboard control panel, advanced - iBed Watch option

The **iBed Watch** screen displays the **iBed Watch** functions of the product.

When enabled, **iBed Watch** alerts when changes are made to the selected bed settings:

- Low height
- Siderails up
- Head angle
- Bed flat

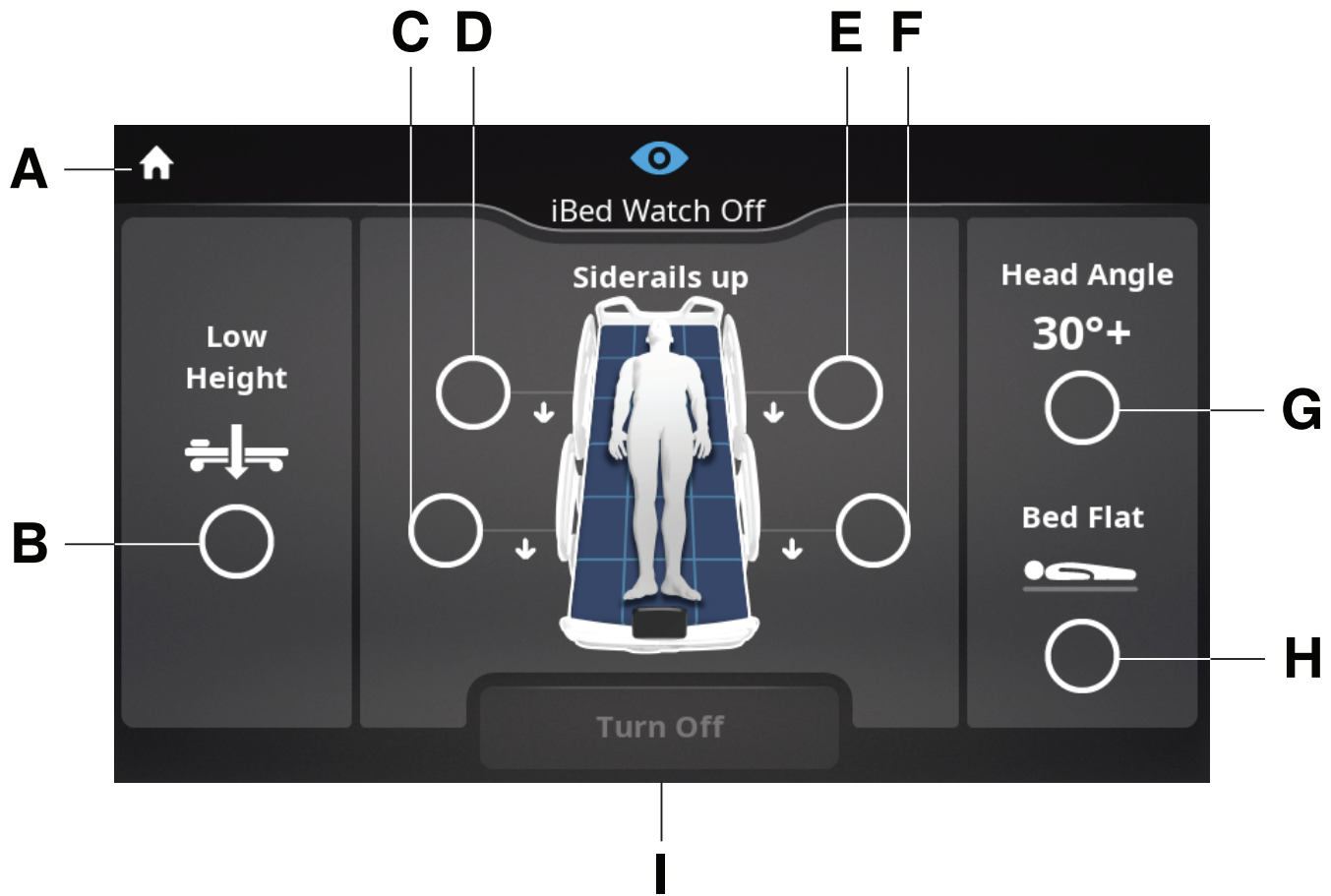

A	Home	Returns to the Home screen (<i>Footboard control panel, advanced - Home option (page 45)</i>)
B	Low Height	Monitors low height of the bed
C	Foot right siderail	Monitors foot right siderail in the highest position
D	Head right siderail	Monitors head right siderail in the highest position
E	Head left siderail	Monitors head left siderail in the highest position
F	Foot left siderail	Monitors foot left siderail in the highest position
G	Head Angle	Monitors head angle of the bed
H	Bed Flat	Monitors bed flat position
I	Turn Off	Turns off iBed Watch

Enabling or disabling iBed Watch, advanced option

To enable **iBed Watch**:

1. Position the patient on the product.
2. On the **Home** screen, press the **iBed Watch** button (I) (*Footboard control panel, advanced - Home option (page 45)*).
3. Select the desired bed settings to monitor (*Footboard control panel, advanced - iBed Watch option (page 57)*).

If you change the monitored settings for **iBed Watch**:

- Bed Exit priority signal sent (*Setting up wired nurse call communication (page 16)*)

- LEDs on the footboard and siderails flash red
- Sound alarm is triggered

To disable iBed Watch, press **Turn Off (I)** (*Footboard control panel, advanced - iBed Watch option (page 57)*).

Footboard control panel - Menu

The **Menu** screen displays the functions available to view or change for the product.

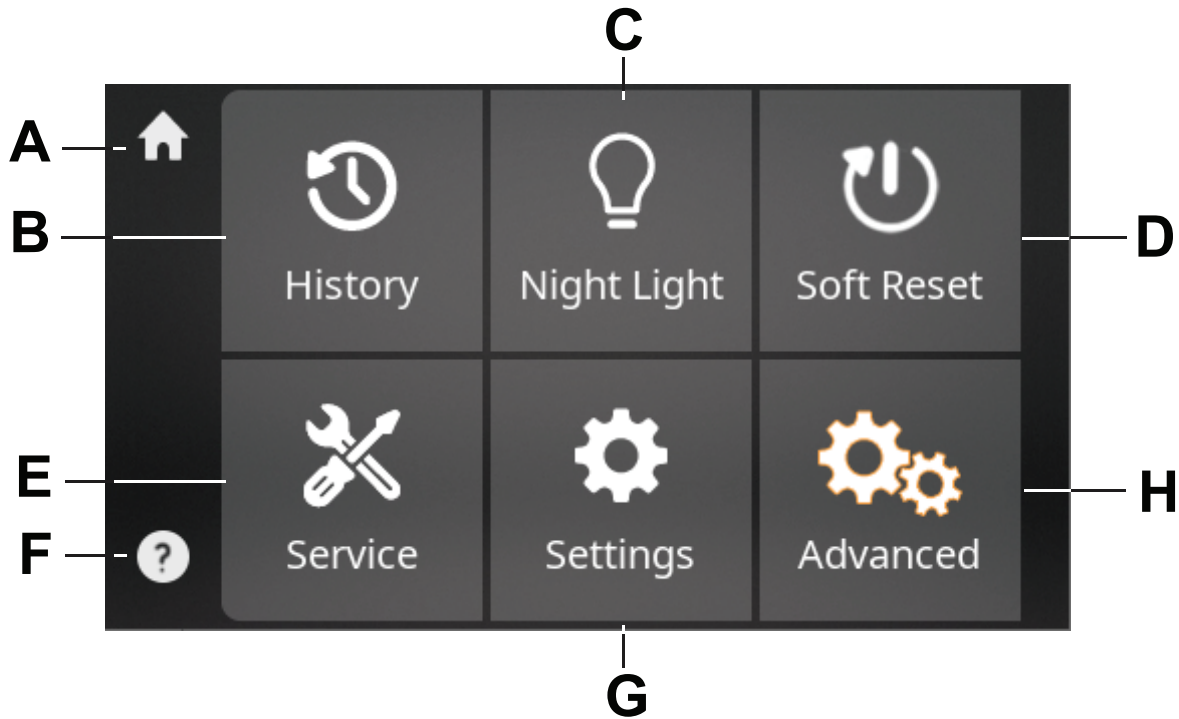

A	Home	Returns to the Home screen (<i>Footboard control panel - Home (page 44)</i>)
B	History	Displays the Scale History screen
C	Night Light	Select to toggle through the following: Night light on, night light automatic, night light off
D	Soft Reset	Select to reset the bed configuration
E	Service	Displays service info, options to view current bed configuration, and error codes
F	Help	Displays a QR code and web address for further information
G	Settings	Displays settings
H	Advanced	Displays advanced settings Note - Press and hold the Settings button (G) to display the Advanced button.

Settings	
Lighting	Select to adjust the display brightness or set to automatic
Low height range	Select to toggle the low height range of the product

Settings	
Scale info	Displays the current software version, local gravity, and calibrated gravity
Wi-Fi info	Displays the MAC address, connection type, IP address, SSID, signal strength, and BSSID
iBed Locator	Displays the locator ID and locator battery status
Set time format	Select to toggle between a 12hr or 24hr time format

Advanced Settings	
iBed Watch preset	Select to choose the iBed Watch presets
Hospital settings	Select to choose the new patient reminders and head angle of the product
Language	Select to choose the user interface language of the product
Scale units	Select to toggle between kg or lb for scale units

Footboard control panel, advanced - Menu option

The **Menu** screen displays the functions available to view or change for the product.

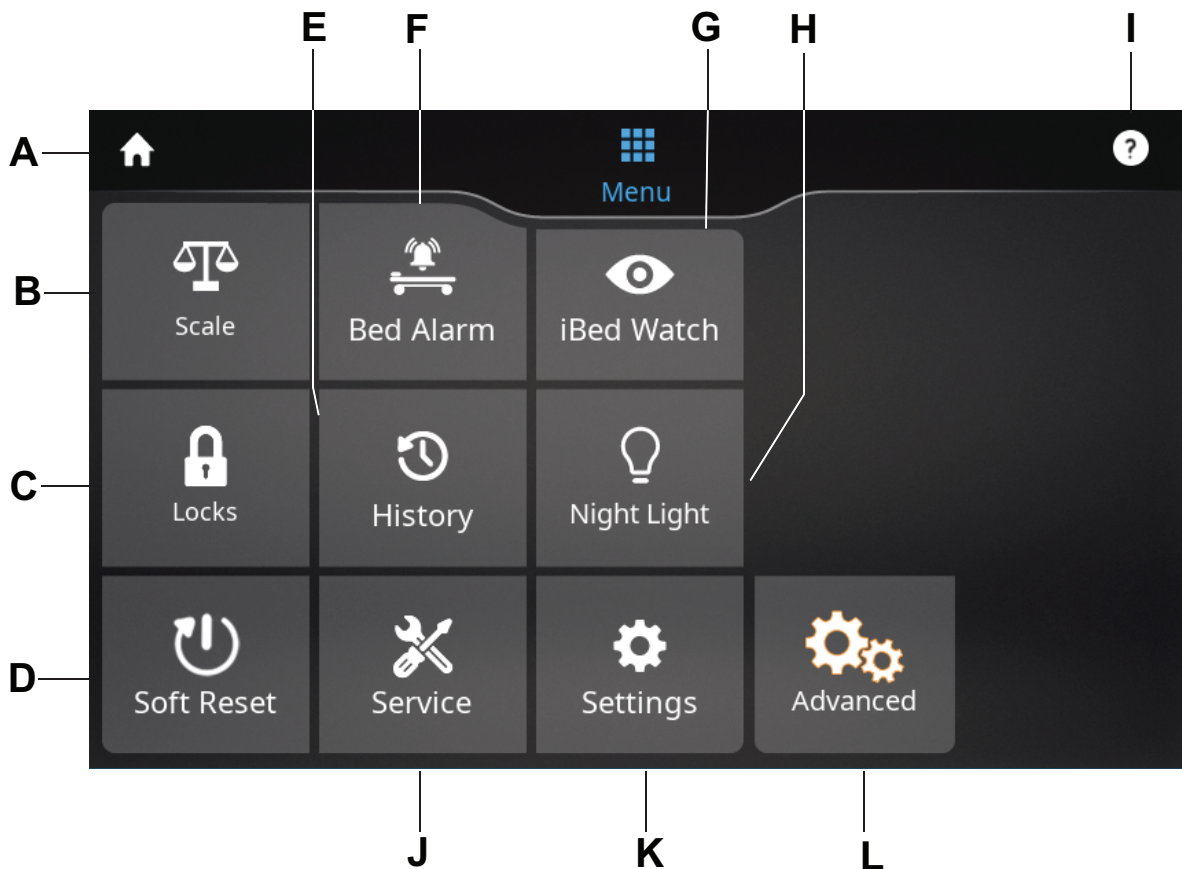

A	Home	Returns to the Home screen (<i>Footboard control panel, advanced - Home option (page 45)</i>)
B	Scale	Displays scale functions (<i>Footboard control panel, advanced - Scale option (page 51)</i>)

C	Motion lock	Displays lockout functions (<i>Footboard control panel, advanced - Motion lock option (page 48)</i>)
D	Soft Reset	Select to reset the bed configuration
E	History	Displays the Scale History screen
F	Bed Exit	Activates and displays Bed Exit functions (<i>Footboard control panel, advanced - Bed Exit option (page 55)</i>)
G	iBed Watch	Activates and displays iBed Watch functions (<i>Footboard control panel, advanced - iBed Watch option (page 57)</i>)
H	Night Light	Select to toggle through the following: Night light on, night light automatic, night light off
I	Help	Displays a QR code and web address for further information
J	Service	Displays service info, options to view current bed configuration, and error codes
K	Settings	Displays settings
L	Advanced	Displays advanced settings Note - Press and hold the Settings button (M) to display the Advanced button.

Settings	
Lighting	Select to adjust the display brightness or set to automatic
Low height range	Select to toggle the low height range of the product or place the product in the vascular position (Figure 22)
Scale info	Displays the current software version, local gravity, and calibrated gravity
Wi-Fi info	Displays the MAC address, connection type, IP address, SSID, signal strength, and BSSID
iBed Locator	Displays the locator ID and locator battery status
Set time format	Select to toggle between a 12hr or 24hr time format



Figure 22 – Low height range

Advanced Settings	
iBed Watch preset	Select to choose the iBed Watch presets
Hospital settings	Select to choose the new patient reminders and head angle of the product
Language	Select to choose the user interface language of the product
Scale units	Select to toggle between kg or lb for scale units

Clearing a detected motion obstruction

WARNING - Do not use manual override to avoid the risk of product damage.

To clear a detected motion obstruction:

1. Press **Press and Hold** (Figure 23). The product moves to clear the obstruction while you press and hold the selection.

Note - The arrow shows the direction the product will move to clear the obstruction. When you remove the obstruction, the selection turns green.



Figure 23 – Obstruction detected

2. Release **Press and Hold**. The **Check for items stopping motion** message appears. Press **OK**.

Note - The screen will disappear in 30 seconds if you do not press **OK**.

3. You can return to normal product motion.

Accessories and parts

These accessories and parts may be available for use with your product. Confirm availability for your configuration or region.

Name	Number
Battery, bed	700000341245
Battery, Zoom	700000341246
Foot extender mattress assembly	300900670805
Bed extender mattress, international	300900670905
Defibrillator tray	300900450250
HAVASU™ two-stage IV pole, single	300900350100
HAVASU two-stage IV pole, dual, top	300900350200
HAVASU two-stage IV pole, dual, bottom	300900350250
Line management (pack of 50)	300900450008
Patient helper bracket	300900450100
Zimmer® patient helper bracket	300900450105
Pendant, basic	300900470100
Pendant, advanced	300900470200
Roller bumper	300900450200
Upright oxygen bottle holder (standard)	300900450050
Upright oxygen bottle holder (large)	300900450150

Note - For the complete dual **HAVASU** two-stage IV pole option, make sure that you select both 300900350200 and 300900350250.

Raising or lowering the HAVASU IV pole option

CAUTION

- Do not load the IV pole above the safe working load of 17.6 lb (8 kg).
- Do not load an individual IV pole hook above the safe working load of 8.8 lb (4 kg).
- Do not use the IV pole as a push or pull device.

To position the **HAVASU** IV pole:

1. Lift and pivot the IV pole from the storage position and push down until the IV pole locks into the receptacle.
2. To raise the height of the pole, pull up on the telescoping portion (A) of the pole until it locks into place at the fully raised position (Figure 24).
3. Rotate the IV hangers (B) to the desired position and hang the IV bags (Figure 24).
4. To lower the pole, turn the latch (C) clockwise until the telescoping portion (A) lowers into the bottom tube (Figure 24).
5. Lift up and pivot the pole down into the storage position.

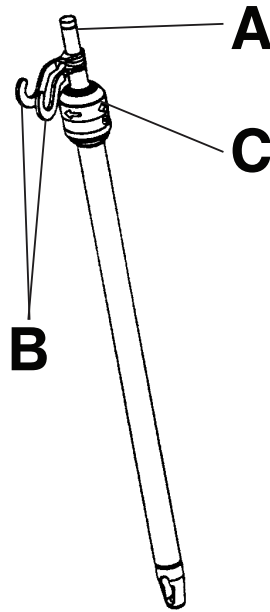

Figure 24 – HAVASU two-stage IV pole

Attaching or removing the patient helper option

WARNING - Always use two people to attach or remove the patient helper.

CAUTION

- Always secure the lifting pole in the mounting bracket before you adjust the patient helper.
 - Always remove the patient helper before you transport the product.
-

You can attach the patient helper to the patient helper mounting bracket at the head end of the product.

To attach the patient helper:

1. Insert the lifting pole (A) into the mounting bracket (B) (Figure 25).
2. Rotate the lifting pole in the mounting bracket until the patient helper knob (C) locks in position (Figure 25).

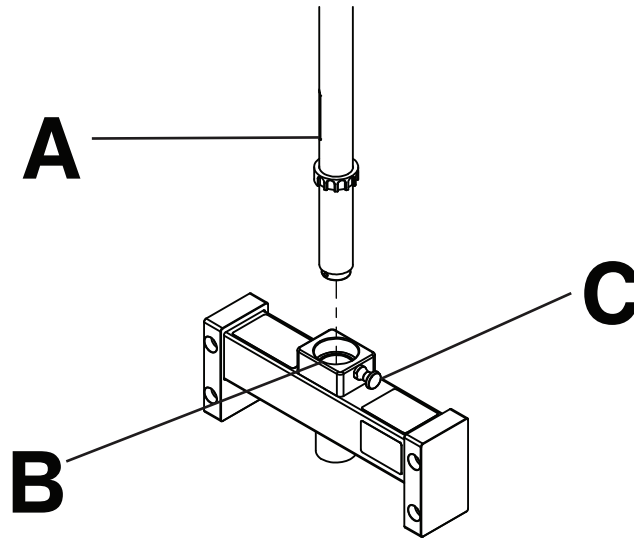

Figure 25 – Attaching or removing the patient helper

Reverse steps to remove the patient helper.

Adjusting the patient helper option

WARNING - Do not load the patient helper above the safe working load of 200 lb (90.7 kg).

CAUTION

- Always secure the lifting pole in the mounting bracket before you adjust the patient helper.
 - Do not use the patient helper as a push or pull device.
 - Always check that the patient helper mounting bracket is secure before use.
-

The patient helper assists the patient to change position in bed.

To adjust the patient helper:

1. Pull the patient helper knob (A) and rotate the lifting pole (B) until the desired position (Figure 26).
2. Release the patient helper knob (A) and rotate the lifting pole (B) until the knob locks in position (Figure 26).
3. Lift the trapeze hanger bracket (C) and move it forward or backward until the desired position (Figure 26).
4. Secure the trapeze hanger in one of the keyed positions on the lifting pole.

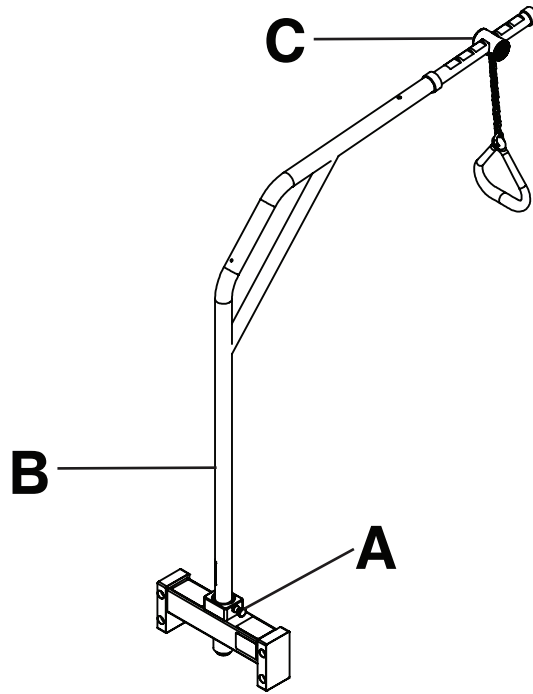

Figure 26 – Adjusting the patient helper

Attaching the oxygen bottle holder

CAUTION

- Do not load the standard oxygen bottle holder (300900450050) above the safe working load of 15 lb (6.8 kg).
 - Do not load the large oxygen bottle holder (300900450150) above the safe working load of 40 lb (18.1 kg).
 - Do not use the oxygen bottle holder as a push or pull device.
-

Insert the oxygen bottle holder support bar into the accessory socket that is located on either side of the product at the head end and foot end.

Attaching the defibrillator tray option

CAUTION

- Do not load the defibrillator tray above the safe working load of 40 lb (18.1 kg).
 - Do not use the defibrillator tray as a push or pull device.
-

The defibrillator tray supports a defibrillator at the foot end of the product.

To attach the defibrillator tray:

1. Position the defibrillator tray over the product.
2. Insert the tray weldment frame (A) into the traction posts (B) at the foot end of the product (Figure 27).

Note - Always secure the equipment to the defibrillator tray with the strap (C) when in use.

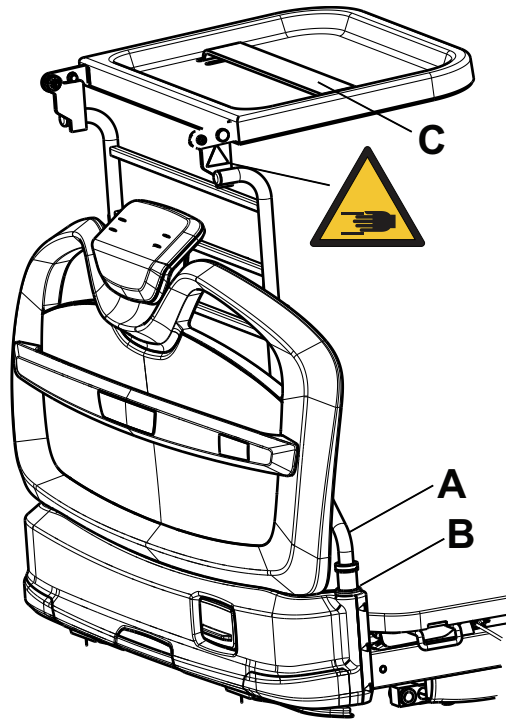

Figure 27 – Attaching the defibrillator tray

Operating the defibrillator tray option

To operate the defibrillator tray:

1. Flip tray up to use.
2. Using the strap (C), strap the defibrillator to the defibrillator tray (Figure 27).

Cleaning and disinfecting with SideKick®

For United States only. Confirm availability for your configuration or region. Call Stryker Customer Service: 1-800-327-0770.

Stryker's preferred wipes (2060-000-001 6" x 10" or 2060-000-002 9" x 12") and spray (2070-000-001) include the following active ingredients:

- n-Alkyl (60% C14, 30% C16, 5% C12, 5% C18) dimethyl benzyl ammonium chloride - 0.154%
- n-Alkyl (68% C12, 32% C14) dimethyl ethylbenzyl ammonium chloride - 0.154%
- Isopropanol - 21.000%

Non-active ingredient: Ethylene Glycol Monobutyl Ether – < 3%

Note - For safety information, read the product label.

To clean or disinfect the external product surface with SideKick wipe:

To clean:

1. Wipe down the external product surface with a fresh, clean wipe to remove all visible soils.
2. Repeat as necessary until the external product surface is visibly clean.
3. Wipe dry with a cloth or allow the external product surface to air dry before you return the product to service.

Note - Use as many wipes as necessary.

To disinfect:

1. Clean first.
2. Wipe down the external product surface with a fresh, clean wipe until wet.
3. Allow the external product surface to remain wet for two minutes at room temperature.
4. Wipe dry with a cloth or allow the external product surface to air dry before you return the product to service.

To clean or disinfect the external product surface with SideKick spray:

To clean:

1. Spray **SideKick** on a mop, sponge, paper cloth, or cloth towel.
2. Wipe down the external product surface with a fresh, clean mop, sponge, paper cloth, or cloth towel to remove all visible soils.
3. Repeat as necessary until the external product surface is visibly clean.
4. Wipe dry with a cloth or allow the external product surface to air dry before you return the product to service.

To disinfect:

1. Clean first.
2. Spray **SideKick** on a mop, sponge, paper cloth, or cloth towel.
3. Wipe down the external product surface with a fresh, clean mop, sponge, paper cloth, or cloth towel until wet.
4. Allow the external product surface to remain wet for two minutes at room temperature.
5. Wipe dry with a cloth or allow the external product surface to air dry before you return the product to service.

Note - Follow your hospital protocols to launder cloth towels or dispose of wipes or paper cloths.

Cleaning

CAUTION

- Do not clean, disinfect, service, or perform maintenance while the product is in use.
 - Always unplug the power cord from the wall outlet when large spills occur near the circuit boards, cables, and motors. Remove the occupant from the product, clean up the fluid, and inspect the product. Fluids can cause unpredictable operation and decreased functionality of any electrical product. Do not return the product to service until dry and tested for safe operation.
-

Recommended cleaning method:

1. Hand wash all exposed surfaces of the product with a mild detergent by spray or pre-soaked wipes.
2. Follow the cleaning solution manufacturer's instructions for appropriate contact time and rinse requirements.
3. Dry the product before you return it to service.

Note - Avoid oversaturation. Do not allow the product to remain wet.

Disinfecting

CAUTION

- Do not clean, disinfect, service, or perform maintenance while the product is in use.
 - Always unplug the power cord from the wall outlet when large spills occur near the circuit boards, cables, and motors. Remove the occupant from the product, clean up the fluid, and inspect the product. Fluids can cause unpredictable operation and decreased functionality of any electrical product. Do not return the product to service until dry and tested for safe operation.
 - Always wipe down with clean water (or 70% isopropyl alcohol, if using **Virex® TB**) and dry each product after disinfecting. Some disinfectants are corrosive in nature and may cause damage to the product. If you do not rinse and dry the product, you may leave a corrosive residue on the surface of the product. This corrosive residue could cause premature degradation of critical components. Failure to follow these disinfecting instructions may void your warranty.
-

Recommended disinfectants for this product's surfaces include:

- Quaternary (active ingredient - ammonium chloride)
- Phenolic (active ingredient - o-phenylphenol)
- Chlorinated bleach solution (10,000 ppm available chlorine, 941 mL of a 5.25% sodium hypochlorite solution per 4000 mL of water)
- Alcohol (active ingredient - 70% isopropyl alcohol)
- Accelerated hydrogen peroxide (AHP) 10,000 ppm hydrogen peroxide (ready-to-use Oxivir TB (1.0% hydrogen peroxide or less)) and additional additives to not exceed 0.13% peroxyacetic acid

Disinfection method:

1. Follow the disinfectant solution manufacturer's dilution recommendations.
2. Apply the recommended disinfectant solution by spray or pre-soaked wipes.
3. Hand wash all exposed surfaces of the product with the recommended disinfectant.
4. Dry the product before you return it to service.

Note

- Avoid oversaturation. Do not allow the product to remain wet.
- Follow the manufacturer's dilution recommendations for appropriate contact time and rinse requirements. Follow the chemical manufacturer's guidelines to disinfect.

Preventive maintenance

Remove the product from service before you perform the preventive maintenance inspection. Check all items listed during annual preventive maintenance for all Stryker Medical products. You may need to perform preventive maintenance checks more often based on your level of product usage. Service only by qualified personnel.

Note - Clean and disinfect the exterior of the support surface before inspection, if applicable.

Inspect the following items:

- _____ All fasteners are secure
- _____ Apply brake pedal and push on bed to confirm that all casters lock
- _____ Footboard and head end siderails flash when brakes are not applied
- _____ Steer caster locks and unlocks
- _____ Siderails move and latch in the highest and intermediate positions
- _____ Fowler CPR release operable on both sides
- _____ IV pole is intact and operable option
- _____ Foley bag hooks intact
- _____ No cracks or splits in headboard, footboard, or siderail panels
- _____ No rips or cracks in mattress cover
- _____ All functions on head end siderails operable (includes LEDs)
- _____ All functions on footboard operable (includes LEDs)
- _____ Calibrate the scale and Bed Exit system
- _____ Motion interrupt operable (below the bed extender)
- _____ Night light operable
- _____ Main/auxiliary outlet power cords and plugs not frayed or damaged
- _____ No cables worn or pinched
- _____ All electrical connections tight
- _____ All grounds secure to frame
- _____ Ground impedance not more than 200 mΩ (milliohms)
- _____ Current leakage not more than 300 μA (microamps)
- _____ Ground chain is clean, intact, and has at least two links touching the floor
- _____ Fowler angle accuracy is 0° - 65°
- _____ Footboard and siderail status lights operable
- _____ Inspect footboard and siderail controls for signs of degradation
- _____ Inspect Fowler dampener for oil leaks
- _____ All motions function
- _____ Nurse call functions
- _____ **iBed** Wireless IR module is intact and footboard icons display option
- _____ Foot end and head end litter bumper intact and not damaged
- _____ Replace bed batteries
- _____ Electric brakes apply and release with footboard and siderail controls option
- _____ **Secure Connect** option shows connected when brakes are applied
- _____ **Zoom** handles move and latch in the upright position option

____ **Zoom** drives forward and backward when throttle is rotated option

____ **Zoom** throttle returns to neutral position when released and **Zoom** motion stops option

Product serial number:
Completed by:
Date:

Wireless notifications

For product equipped with optional wireless communication technology, these statements apply to the countries as indicated:

Country	Notification			
Canada	<p>Contains IC: 4919E-SDMACP Contains IC: 5123A-BGTWT32I</p> <p>This device complies with Innovation, Science and Economic Development Canada's license-exempt RSSs. Operation is subject to the following two conditions: (1) this device may not cause interference, and (2) this device must accept any interference, including interference that may cause undesired operation of the device.</p> <p>Le présent appareil est conforme aux CNR d'Industrie Canada applicables aux appareils radio exempts de licence. L'exploitation est autorisée aux deux conditions suivantes : (1) l'appareil ne doit pas produire de brouillage, et (2) l'utilisateur de l'appareil doit accepter tout brouillage radioélectrique subi, même si le brouillage est susceptible d'en compromettre le fonctionnement.</p>			
Israel	<p>מספר אישור אלחוטי של משרד התקשורת הוא 51-78775 אסור להחליף את האנטנה המקורית של המכשיר ולא לעשות בו כל שינוי טכני אחר</p>			
Mexico	<p>La operación de este equipo está sujeta a las siguientes dos condiciones: (1) es posible que este equipo o dispositivo no cause interferencia perjudicial y (2) este equipo o dispositivo debe aceptar cualquier interferencia, incluyendo la que pueda causar su operación no deseada.</p>			
Oman	<table border="1"> <tr> <td>Oman – TRA</td> </tr> <tr> <td>D090024</td> </tr> <tr> <td>TRA/TA-R/10839/21</td> </tr> </table>	Oman – TRA	D090024	TRA/TA-R/10839/21
Oman – TRA				
D090024				
TRA/TA-R/10839/21				
Singapore	<table border="1"> <tr> <td>Complies with IMDA Standards DA103640</td> </tr> </table>	Complies with IMDA Standards DA103640		
Complies with IMDA Standards DA103640				

Country	Notification
Thailand	 <p>เครื่องวิทยุคมนาคมนี้ ได้รับยกเว้น ไม่ต้องได้รับใบอนุญาตให้มี ใช้ซึ่งเครื่องวิทยุคมนาคมหรือตั้งสถานีวิทยุคมนาคมตามประกาศ กสทช. เรื่อง เครื่องวิทยุคมนาคม และสถานีวิทยุคมนาคมที่ได้รับยกเว้นไม่ต้องได้รับใบอนุญาตวิทยุคมนาคมตามพระราชบัญญัติวิทยุคมนาคม พ.ศ. 2498</p> <p>เครื่องวิทยุคมนาคมนี้มีอัตราการดูดกลืนพลังงานจำเพาะ (Specific Absorption Rate - SAR) อันเนื่องมาจากเครื่องวิทยุคมนาคมเท่ากับ 0.33 W/kg ซึ่งสอดคล้องตามมาตรฐานความปลอดภัยต่อสุขภาพของมนุษย์จากการใช้เครื่องวิทยุคมนาคมที่คณะกรรมการกิจการโทรคมนาคมแห่งชาติประกาศกำหนด</p>
United States	<p>Contains FCC ID: Z7A-SDMACP Contains FCC ID: QOQWT32I</p> <p>This device complies with Part 15 of the FCC Rules. Operation is subject to the following two conditions: (1) this device may not cause harmful interference, and (2) this device must accept any interference received, including interference that may cause undesired operation.</p> <p>Changes or modifications not expressly approved by the party responsible for compliance could void the user's authority to operate the equipment.</p> <p>Frequency Tolerance: +/-20 ppm</p>

Wireless coexistence notifications

Microwaves are regulated by the federal government through 21CFR1030.10 such that the amount of power that can leak from a microwave oven over its lifetime is very small, such as 5mW/cmsq @ 2" from the plane of the microwave surface. This radiation will roll off rapidly as the distance between the microwave and the measurement point increases. Other radiation in this band can be generated from unintentional radiators and from the control and source circuitry in the microwave. The level of this radiation is also controlled via federal regulations from the FCC and is not of a high magnitude. Both these two sources of noise are both contained inside the microwave oven which is shielded and designed to minimize this radiation. In general, the user of the medical device will not be in close proximity to the microwave oven when using the medical device.

Coexistence between IEEE802.11 (Wi-Fi) 5GHz band devices and LTE-U Cellular Band (B46) device is well established and well vetted by regulatory bodies. That being said, in high congestion environments (such as the intended environment of this device) these overlapping frequencies can degrade performance of both devices. It is highly recommended to disable customer infrastructure utilizing LTE-U Cellular Band (B46) to avoid any degradation of performance. Doing so will increase 5GHz capacity and reduce performance degradation resulting from frequency congestion.

EMC information

WARNING

- Portable RF communications equipment, including peripherals such as antenna cables and external antennas, should be no closer than 12 inches (30 cm) to any part of **ProCuity** bed series, including cables specified by the manufacturer.
- Avoid stacking or placing equipment adjacent with other equipment to prevent improper operation of the product. If such use is necessary, carefully observe stacked or adjacent equipment to make sure that they operate properly.
- The use of accessories, transducers, and cables, other than those specified or provided by the manufacturer, could result in increased electromagnetic emissions or decreased electromagnetic immunity and result in improper operation.

The **ProCuity** bed series was evaluated using the following cables:

Cable	Length (m)
AC mains input cable	2.5
AC aux input cable	2.5
AC aux output cable	2.2
Nurse call (DB-37)	4.5
USB cable	4.7
Pendant	5.3

Guidance and manufacturer's declaration - electromagnetic emissions

The **ProCuity** bed series is intended for use in the electromagnetic environment specified below. The customer or the user of the **ProCuity** bed series should assure that it is used in such an environment.

Emissions test	Compliance	Electromagnetic environment
RF Emissions CISPR 11	Group 1	Note - The emissions characteristics of this equipment make it suitable for use in industrial areas and hospitals (CISPR 11 class A). If it is used in a residential environment (for which CISPR 11 class B is normally required) this equipment might not offer adequate protection to radio-frequency communication services. The user might need to take mitigation measures, such as relocating or re-orienting the equipment.
RF Emissions CISPR 11	Class A	
Harmonic Emissions IEC 61000-3-2	Class A	
Voltage Fluctuations Flicker Emissions IEC 61000-3-3	Complies	

Guidance and manufacturer's declaration - electromagnetic immunity

The **ProCuity** bed series is suitable for use in a professional healthcare facility environment and not in environments exceeding immunity test conditions that the product was evaluated to, such as near high frequency (HF) surgical equipment and inside of the radio frequency (RF) shielded room of magnetic resonance imaging (MRI) equipment. The customer or the user of the **ProCuity** bed series should assure that it is used in such an environment and that the electromagnetic environment guidance listed below is followed.

Immunity test	IEC 60601 test level	Compliance level	Electromagnetic environment-guidance
Electrostatic Discharge (ESD) IEC 61000-4-2	±8 kV contact ±15 kV air	±8 kV contact ±15 kV air	Floors should be wood, concrete, or ceramic tile. If floors are covered with synthetic material, the relative humidity should be at least 30%.

Guidance and manufacturer's declaration - electromagnetic immunity

Electrostatic fast transient/ burst IEC 61000-4-4	±2 kV for power supply lines ±1 kV for input/output lines	±2 kV for power supply lines ±1 kV for input/output lines	Main power quality should be that of a typical commercial or hospital environment.
Surge IEC 61000-4-5	±0.5 kV, ±1 kV lines to lines ±0.5 kV, ±1 kV, ±2 kV lines to earth	±0.5 kV, ±1 kV lines to lines ±0.5 kV, ±1 kV, ±2 kV lines to earth	Main power quality should be that of a typical commercial or hospital environment.
Voltage dips, voltage variations and short interruptions on power supply input lines IEC 61000-4-11	0%U _T for 0.5 cycle at 0°, 45°, 90°, 135°, 180°, 225°, 270°, and 315° 0%U _T for 1 cycle 70%U _T (30% dip in U _T) for 25/30 cycles 0% U _T for 250/300 cycles	0%U _T for 0.5 cycle at 0°, 45°, 90°, 135°, 180°, 225°, 270°, and 315° 0%U _T for 1 cycle 70%U _T (30% dip in U _T) for 25/30 cycles 0% U _T for 250/300 cycles	Main power quality should be that of a typical commercial or hospital environment. If the user of the ProCuity bed series requires continued operation during power main interruptions, it is recommended that the device be powered from an uninterrupted power supply or a battery.
Power frequency (50/60 Hz) magnetic field IEC 61000-4-8	30 A/m	30 A/m	Power frequency magnetic fields should be at levels characteristic of a typical location in a typical commercial or hospital environment.

Note - U_T is the a.c. mains voltage before applications of the test level.

<p>Conducted RF IEC 61000- 4-6</p> <p>Radiated RF IEC 61000-4-3</p>	<p>3 Vrms 150 kHz to 80 MHz 3 V/m 80 MHz to 2.7 GHz</p>	<p>3 Vrms 3 V/m</p>	<p>Portable and mobile RF communications equipment should follow the guidance in the table titled “Recommended separation distances between portable and mobile RF communication equipment and the ProCuity bed series.” If the mobile service is not listed in the table, the recommended separation distance should be calculated from the equation appropriate for the frequency of the transmitter.</p> <p>Recommended separation distance $D=(2)(\sqrt{P})$ where P is the maximum output power rating of the transmitter in watts (W) according to the transmitter manufacturer and d is the recommended separation distance in meters (m).</p> <p>Field strengths from fixed RF transmitters, as determined by an electromagnetic site survey^a, should be less than the compliance level in each frequency range^b.</p> <p>Interference may occur in the vicinity of equipment marked with the following symbol: </p>
---	---	-------------------------	--

Note - These guidelines may not apply in all situations. Electromagnetic propagation is affected by absorption and reflection from structures, objects and people.

Note - The ISM (Industrial, Scientific, and Medical) bands between 0.15 MHz and 80 MHz are 6.765 MHz to 6.795 MHz; 13.553 MHz to 13.567 MHz; 26.957 MHz to 27.283 MHz; and 40.66 MHz to 40.70 MHz.

^aField strengths from fixed transmitters, such as base stations for radio (cellular/cordless) telephones and land mobile radios, amateur radio, AM and FM radio broadcast, and TV broadcast cannot be predicted theoretically with accuracy. To assess the electromagnetic environment due to fixed RF transmitters, an electromagnetic site survey should be considered. If the measured field strength in the location in which the **ProCuity** bed series is used exceeds the applicable RF compliance level above, the **ProCuity** bed series should be observed to verify normal operation. If abnormal performance is observed, additional measures may be necessary, such as reorienting or relocating the **ProCuity** bed series.

^bOver the frequency range 150 kHz to 80 MHz, field strengths are less than 3 Vrms.

Recommended separation distances between portable and mobile RF communication equipment and the ProCuity bed series

The **ProCuity** bed series is intended for use in an electromagnetic environment in which radiated RF disturbances are controlled. The customer or the user of the **ProCuity** bed series can help prevent electromagnetic interferences by maintaining a minimum distance between portable and mobile RF communications equipment (transmitters) and the **ProCuity** bed series, including cables, as recommended below, according to the maximum output power of the communications equipment.

Band (MHz)	Service	Maximum power (W)	Minimum separation distance (m)
380-390	TETRA 400	1.8	0.3
430-470	GMRS 460; FRS 460	2.0	0.3
704-787	LTE Band 13, 17	0.2	0.3
800-960	GSM 800/900; TETRA 800; iDEN 820; CDMA 850; LTE Band 5	2.0	0.3
1,700-1,990	GSM 1800; CDMA 1900; GSM 1900; DECT; LTE Band 1, 3, 4, 25; UMTS	2.0	0.3
2,400-2,570	Bluetooth; WLAN; 802.11 b/g/n; RFID 2450; LTE Band 7	2.0	0.3
5,100-5,800	WLAN 802.11 a/n	0.2	0.3

For transmitters rated at a maximum output power not listed above, the recommended separation distance d in meters (m) can be estimated using the equation applicable to the frequency of the transmitter, where P is the maximum output power rating of the transmitter in watts (W) according to the transmitter manufacturer.

Note - These guidelines may not apply in all situations. Electromagnetic propagation is affected by absorption and reflection from structures, objects and people.

stryker



Stryker Medical
3800 E. Centre Avenue
Portage, MI 49002
USA