



XPRT
Therapy Mattress
Model 2950

stryker®

Operations/Maintenance Manual



For Parts or Technical Assistance:
USA: 1-800-327-0770 (option 2)
Canada: 1-888-233-6888



Table of Contents

Introduction	6
Specifications	6
Product Technical Description	7
System Diagram and Component Identification	7
Warning /Caution / Note Definition	8
Summary of Safety Precautions	9
Scales	10
Bed Exit System	10
Indications for Use	11
Contraindications	11
Precautions	11
Symbols	12
Setup Procedures	13
Installing the Mattres and the Pendant	13
Powering Up the Mattress	15
Controller Backlighting	16
Therapy Modes	17
Normal Therapy Mode	17
Rotation/Percussion/Vibration Therapy Modes	17
Pressure Relief	18
Low Air Loss (LAL)	18
Sloped Heel Section	18
Operation Guide - Rotation Therapy	19
Scales	19
Bed Exit System	19
To Prepare for Rotation Therapy	20
Patient Positioning	20
Bed Positioning	20
To Start Rotation Therapy	21
To Adjust the Active Therapy Parameters	22
To Stop Rotation Therapy	22
Operation Guide - Percussion Therapy	23
To Start Percussion The Therapy	23
To Adjust the Active Therapy Parameters	24
To Stop Percussion Therapy	24
Operation Guide - Vibration Therapy	25
Scales	25
Bed Exit System	25
To Start Vibration Therapy	25
To Adjust the Active Therapy Parameters	26
To Stop Vibration Therapy	26

Table of Contents

Operation Guide - Nursing Features	27
To Start Max Inflate	27
To Stop Max Inflate	28
To Adjust Mattress Firmness	29
Fluoroscopy	30
Patient Positioning	30
To Start Turn-Assist	31
To Stop Turn-Assist	32
To Silence An Alarm	33
To Lock All Functions.	34
To Unlock All Functions	35
Operation Guide - Advanced Settings	36
To Change the Displayed Language	36
To Change the Displayed Language to Spanish	37
To Reset Therapy History	38
To Reset Parameters To Default	39
To View Therapy History	40
To Adjust the Input Volume and Alarm Settings.	41
Operation Guide - CPR.	42
CPR Activation.	42
Nursing Care	44
Transferring a Patient to the XPRT Mattress	44
Transferring a Patient From the XPRT Mattress	44
Transporting a Patient on the Bed	45
Skin Care Guidelines	46
Bathing a Patient	46
Incontinence / Drainage	47
Preventative Maintenance Checklist	48
Cleaning	49
Pendant Cleaning	49
Mattress Cleaning	49
Foot Box Cleaning	49
Troubleshooting Guide	50
Quick Reference Replacement Parts List	53
Service Information.	54
Top Cover Replacement.	54
Foot Box Pump Replacement	54
Foot Box Power Board Replacement.	55
Foot Box Transformer Replacement	55
Head Box CPU Board Replacement	56
Head Box Diaphragm and Slip Disc Replacement	56
Head Box Stepper Motor / Rotary Valve Assembly	57

Table of Contents

Service Information (Continued)	
Cell Assembly Replacement Kit	58
Installation of New Cell Assembly	60
To Access the Service Screen	63
Service Screen Functions	65
Service Codes	67
Alarms / Errors	74
Pneumatic Diagram	75
Foot Box Wiring Block Diagram	76
Head Box Wiring Block Diagram	77
Mattress Assembly - 2950-000-000/2950-000-001	78
Foot Box Assembly - 2950-001-428	82
Pendant Assembly - 2950-047-000	86
Head Box Assembly - 2950-001-417	88
ICU Bed Extender Mattress Only - 2950-100-000	95
Warranty	96
Limited Warranty	96
To Obtain Parts and Service	96
Service Contract Coverage	96
Service Contract Programs	97
Return Authorization	97
Damaged Merchandise	97
International Warranty Clause	97

Introduction

IMPORTANT NOTE:

This manual is designed to assist you with the operation and the maintenance of the Stryker Medical 2950 XPRT Therapy Mattress. Read thoroughly prior to using the equipment or beginning maintenance.

SPECIFICATIONS

Models	2950-000-000 Dartex Cover, 2950-000-001 Nylon Cover
Dimensions	Mattress: 35" x 84" x 8.5" Pendant: 28" x 9" x 4"
Weight	Complete System: 110 pounds Mattress: 104 pounds Pendant: 6 pounds Foot Box Assembly: 8-1/2 pounds
Maximum Patient Weight	500 pounds
Power Cord	15 foot, 16 AWG cord with hospital grade plug for use with wall outlet 3 foot, 16 AWG cord with hospital grade plug for use with access-outlet
Overcurrent Protection	3 fuses - (2) Fuses 5 x 20 mm., 6.3A Slo-blo, 250VAC, (1) Fuse(F1) 1/4 x 1 1/4 in., 7A Slo-blo, 250 VAC
Voltage	120VAC +5% -10% VAC, 2.5A 60 Hz
Operating Ambient Temperature Range	60 F to 85 F (16 C to 30 C) If the system is stored at temperatures below 60 F or above 85 F, the system must be allowed to stabilize for two hours within the specified operating temperature range before use. 
Output Flow Rate	12.5 LPM (0.4 SCFM) minimum @ 30 mmHg
Current Leakage	300uA maximum
Classification	Class I, grounded equipment
	Type BF equipment
	Continuous operation - Not suitable for use in the presence of flammable anesthetic mixture with air or with oxygen or nitrous oxide. Suitable for continuous duty.
	IPX4, Splashproof
	MEDICAL EQUIPMENT, classified with respect to electric shock, fire, mechanical hazards only, in accordance with UL60601-1, CAN/CSA C22.2 NO. 601.1 - M90
	Electromagnetic compatibility, meets EN 60601-1-2, 2001 (CISPR II classified as Class A, Group 1 ISM Equipment)

Introduction

PRODUCT TECHNICAL DESCRIPTION

The XPRT Therapy Mattress is a powered mattress replacement system intended only for use on Stryker frames and other frames supporting a 35 x 84 litter format in the Critical Care environment. It provides low air loss, pressure relief, percussion, vibration and rotation therapies and additional nursing convenience features. The unit consists of a sleep surface, an integrated valve box located in the head of the mattress, a pump box located under the foot of the mattress and a color touch screen controller that can be mounted to either side of the pump box at the foot end of the mattress.

SYSTEM DIAGRAM AND COMPONENT IDENTIFICATION

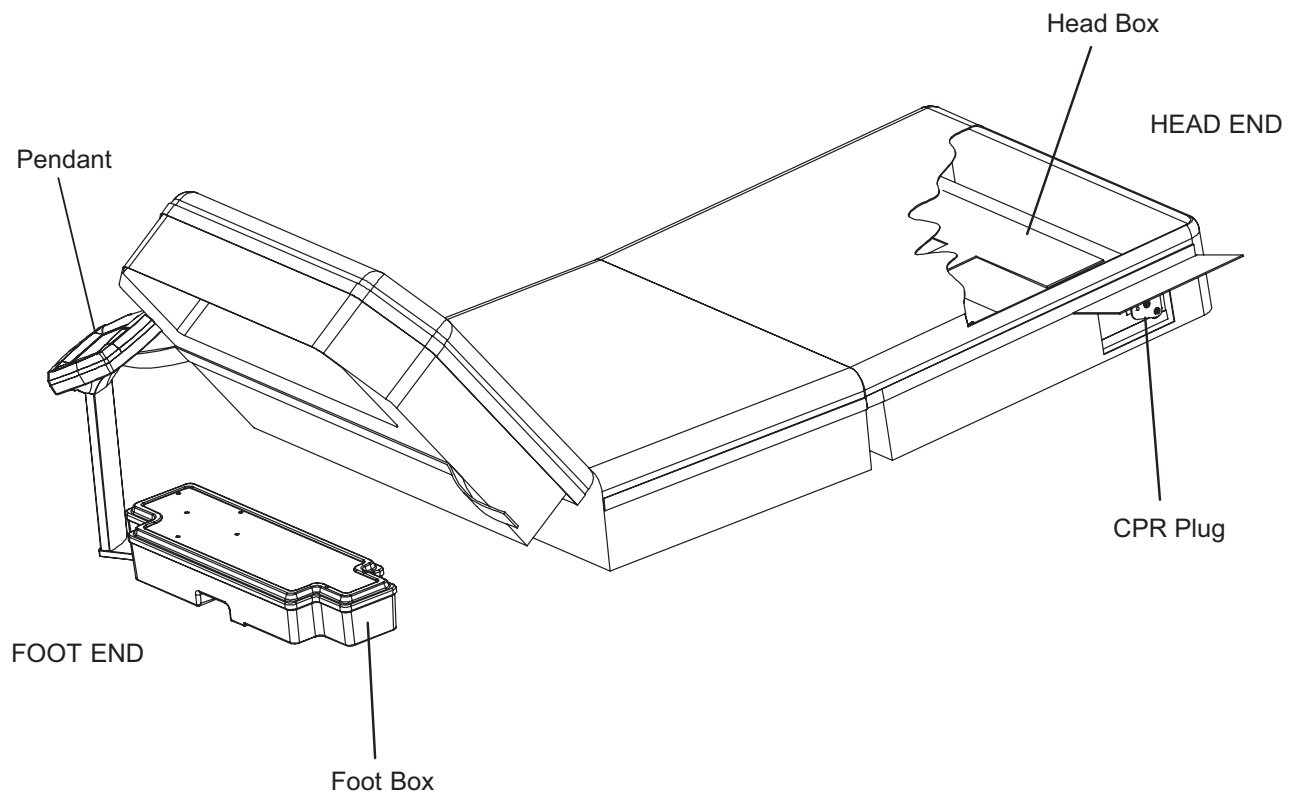

[Return To Table of Contents](#)

Introduction

WARNING /CAUTION / NOTE DEFINITION

These words carry special meanings and should be carefully reviewed.

WARNING

Alerts the reader about the situation about the situation which if not avoided, could result in death or serious injury. It may also describe potential serious adverse reactions and safety hazards.

CAUTION

Alerts the reader of a potentially hazardous situation, which if not avoided, may result in minor or moderate injury to the user or patient or damage to the equipment or other property. This includes special care necessary for the safe and effective use of the device and the care necessary to avoid damage to a device that may occur as a result of use or misuse.

NOTE

This provides special information to make maintenance easier or important instructions clearer.

Summary of Safety Precautions

Before operating or servicing the XPRT Therapy System, it is important to read and understand all information in this manual. Carefully read and strictly follow the safety guidelines listed in this section. The warnings and cautions are repeated throughout the manual, where applicable. To ensure safe operation, methods and procedures must be established for educating and training staff on the safe operation of therapy mattresses. U.S. Federal law restricts this device to be sold by or on the order of a physician.

WARNING

- Explosion risk. Do not use in the presence of flammable anesthetics.
- Electrical shock risk. Refer all servicing to qualified personnel.
- The mattress is equipped with a hospital grade plug for protection against shock hazard. It must be plugged directly into a properly grounded three-prong receptacle. Grounding reliability can be achieved only when a hospital grade receptacle is used.
- Medical electrical equipment requires special precautions regarding EMC and needs to be installed and put into service according to the EMS information provided within this manual to prevent equipment malfunction.
- Portable and mobile RF communication equipment can affect Medical Electrical Equipment.
- Because injury could result, use of pulmonary therapy bed systems for stroke victims should be only under physician's order.
- Do not rotate patients with unstable fractures, unstable spinal cord injuries or those in skeletal traction. Death or serious injury could result.
- Risk of injury. Use of dynamic mattress systems for stroke victims should be only under physician's order.
- It is the caregiver's responsibility to monitor the patient's condition at regular intervals to ensure patient safety.
- Consult physician if redness or skin breakdown occurs.
- Failure to position the patient along the mattress centerline before starting rotation therapy could result in patient injury. Check patient frequently to assure proper positioning and mattress inflation.
- Rotation angle settings approximate the degrees of rotation achieved by a 165 pound patient with an 18 inch shoulder width. The actual amount of rotation achieved is dependent on patient size, patient weight and shoulder width. Monitor the patient for at least one complete cycle to verify the unit achieves the desired angle.
- Ensure that any and all tubing and wiring connected to the patient is long enough, stabilized, and secure to assure safe and unrestricted lateral rotation/elevation of the patient. Be sure to monitor the patient frequently.
- To avoid injury, when using rotation or pulmonary therapy, take care not to extubate intubated patients.
- Always secure the mattress straps to the bed frame to prevent the mattress from sliding and causing patient injury.
- To help ensure patient safety, always raise the bed siderails before beginning therapy.
- Do not leave the patient unattended during Turn Assist. Serious injury could result.
- Deflate the XPRT mattress system or use Max Inflate to inflate it completely before beginning CPR or CPR may be ineffective.
- Disinfect the mattress between patients. Failure to properly disinfect could result in cross-contamination and infection.
- Unplug the mattress power cord from the wall outlet before cleaning the mattress. Failure to unplug the unit could cause equipment damage or personal injury.
- Do not immerse the mattress or foot box in cleaning or disinfectant solutions. Do not allow liquid to pool on the mattress or foot box. Immersion or liquid pooling could cause malfunction resulting in equipment damage or patient injury.

Summary of Safty Precautions

WARNINGS (CONT'D)

- Allow the foot box to completely dry before placing the mattress over it. Excess moisture could cause equipment malfunction resulting in equipment damage or patient injury.
- To reduce risk of patient or user injury and equipment damage, do not exceed the safe working load of the hospital bed frame when supporting both the patient and XPRT therapy mattress.
- If changing the angle of the bed during rotation, monitor the patient for at least one complete cycle to verify the patient achieves the desired angle.
- The service screen and its functions are for use by authorized service personnel only otherwise equipment malfunction could result.
- Do not perform the Diagnostic Test with a patient on the mattress to ensure patient safety.
- Do not perform a Burn-In with a patient on the mattress to ensure patient safety.

To avoid possible injury and to assure proper operation when using the XPRT Therapy Mattress on a bed frame equipped with:

SCALES

- Follow the manufacturer's instructions for use of the scale system.
- Do not zero bed scales or weigh patient with Percussion, Vibration, Rotation or Turn-Assist active. Patient motion and position resulting from the dynamic therapy mattress may adversely affect scale system performance.
- Confirm proper scale system operation following mattress installation. For best results, secure the XPRT therapy mattress power cord to prevent damage to the cord and interference with the bed frame and the scale system.

BED EXIT SYSTEM

- Follow the manufacturer's instructions for use of the bed exit system.
- Do not initialize "Arm" bed exit with Percussion, Vibration, Rotation or Turn-Assist active. The patient motion and position resulting from the dynamic therapy mattress may adversely affect bed exit system performance.
- Confirm proper bed exit system operation when used in conjunction with Percussion, Vibration, Rotation and Turn-Assist.

CAUTION

- Do not drop the head section of the mattress back onto the bed frame. Abruptly dropping the mattress head section could damage the controls, causing malfunction resulting in equipment damage.
- XPRT should not be used adjacent to or stacked with other equipment to avoid malfunction (excluding on a bed). If adjacent or stacked use is necessary, the XPRT device should be observed to verify normal operation in the configuration in which it will be used.
- The mattress cover must be completely dry before storage or adding linens. Failure to remove excess disinfectant could cause degradation of the cover material.
- To avoid patient injury, do not use the side handles to transport the patient.

Summary of Safety Precautions

INDICATIONS FOR USE

The XPRT Therapy Mattress is intended to address pulmonary deficits and assist with the prevention and treatment of pressure ulcers and other complications associated with patient immobility.

CONTRAINDICATIONS

Stryker Medical promotes the clinical assessment of each patient's condition and appropriate therapy administration by the caregiver.

Air support therapy is not recommended for patients with unstable fractures, unstable spinal cord injuries or those in skeletal traction.

Use of powered mattress systems for stroke victims should be only under physician's order.

Percussion/Vibration Therapy is contraindicated in the presence of: multiple rib fractures, persistent intracranial hypertension, bronchospasm and during post-operative periods following cardiac surgery.

Additional contraindications for Rotation, Percussion and Vibration therapies include, but are not limited to:

- Patients with spinal cord injury
- Patients in skeletal traction
- Patients with significant hemoptysis
- Patients for whom a headdown position is contraindicated (e.g., those with a head injury)
- Patients with bleeding disorders
- Patients with rib fractures, or predisposition to pathologic fractures
- Patients for whom the techniques cause increased dyspnea or wheezing.
- Patients who are hemodynamically unstable.

PRECAUTIONS

- Follow all applicable safety rules and protocols concerning patient and caregiver safety.
- To prevent pulling, removal or breakage, stabilize and secure all patient lines and tubing before starting rotation and monitor them frequently.
- Monitor the patient's skin condition regularly to ensure skin integrity.
- Patients with body weight or size near the recommended limits should be monitored more frequently to verify desired results are being achieved.
- Avoid contact of sharp objects with the mattress. Punctures, cuts and tears in the cover could result in contamination of the cushions, prevent proper air pressure control and compromise therapy and safety.
- If fluids spill on any part of the controller or foot box, immediately unplug the power cord from the wall socket. Remove the patient from the mattress and clean up the fluid. Fluids can cause corrosion of components and may cause the mattress to operate erratically or may make some functions completely inoperable. **Do Not** put the mattress back into service until it is completely dry and has been thoroughly tested for safe operation.
- The bed's caster brakes should always be locked except during transport to prevent unintentional movement.
- The bed should always be in the lowest position when the patient is unattended to minimize fall consequences.
- It is the caregiver's responsibility to determine the degree of restraint and the siderail positioning necessary to ensure a patient will remain safely in bed. It is recommended to fully raise the bed's siderails whenever the patient is unattended or the mattress is in the rotation mode.

Symbols



Warning, Refer to Service/Maintenance Manual



Alternating Current



Type B Equipment: equipment providing a particular degree of protection against electric shock, particularly regarding allowable leakage current and reliability of the protective earth connection.

Class 1 Equipment: equipment in which protection against electric shock does not rely on BASIC INSULATION only, but which includes an additional safety precaution in that means are provided for the connection of the EQUIPMENT to the protective earth conductor in the fixed wiring of the installation in such a way that ACCESSIBLE METAL PARTS cannot become live in the event of a failure of the BASIC INSULATION.

Mode of Operation: Continuous

IPX4: Protection from liquid splash



Dangerous Voltage Symbol



Protective Earth Terminal



Potential Equalization Symbol



Medical Equipment Classified by Underwriters Laboratories Inc. with Respect to Electric Shock, Fire, Mechanical and Other Specified Hazards Only in Accordance with UL 60601-1, First Edition (2003) and CAN/CSA C22.2 No. 601.1-M90 with updates 1 and 2.



Safe Working Load Symbol



In accordance with European Directive 2002/96/EC on Waste Electrical and Electronic Equipment, this symbol indicates that the product must not be disposed of as unsorted municipal waste, but should be collected separately. Refer to your local distributor for return and/or collection systems available in your country.

Setup Procedures

INSTALLING THE MATTRES AND THE PENDANT

1. Push pendant onto retainer pin on either side of the footbox.
2. Plug Power cord into footbox.

 **WARNING**

Do not plug into Power Source until assembly is complete.

3. Snap retainer over power cord.

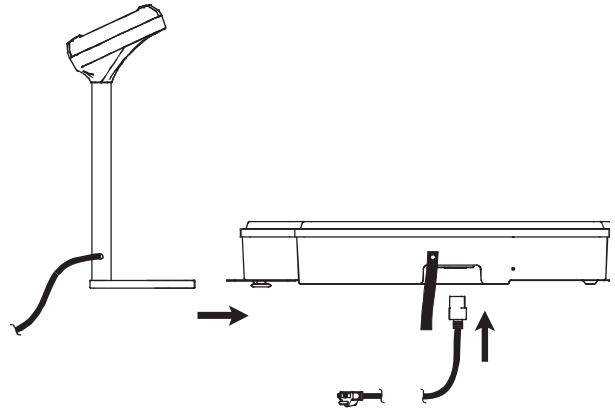

4. Place mattress over bed litter with printed logo at head end of bed.
5. Fold back foot end section of mattress.
6. Place footbox with pendant on foot end of bed litter.

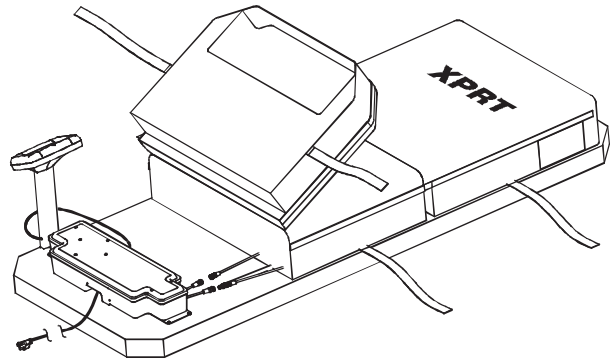

7. Connect the three color coded connectors on the footbox to the corresponding color coded connectors on the mattress.
8. Turn the locking collars clockwise to secure the connections.
9. Connect the air line from the mattress to the corresponding fitting on the footbox.

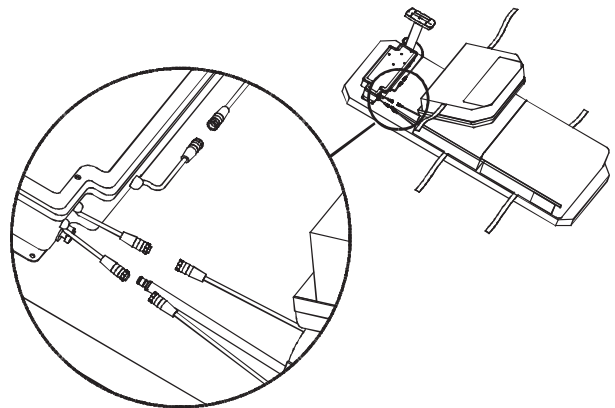

[Return To Table of Contents](#)

Setup Procedures

INSTALLING THE MATTRES AND THE PENDANT (CONT'D)

10. Lower the foot section of mattress over footbox.
11. Attach the mattress to the bed frame using the mattress tie-downs.

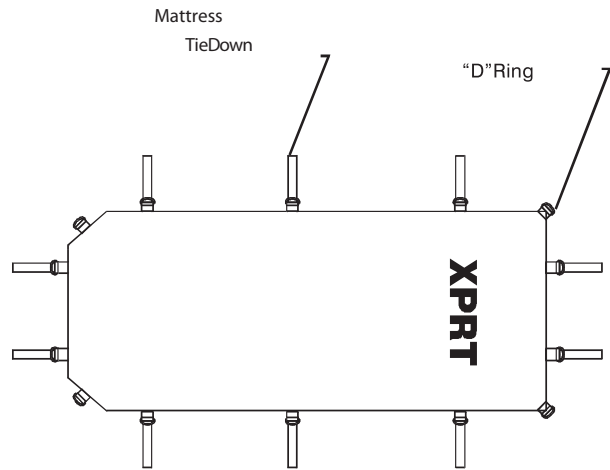

12. Apply linens utilizing the "D" rings for the flat sheet.
13. To secure linens (a), to mattress (b), thread four corners through D-Rings (c) to attach to mattress as shown in the diagram to the right.
14. To ensure proper therapy, do not pull linens taut. Linens should remain loose and wrinkly on surface of the mattress.

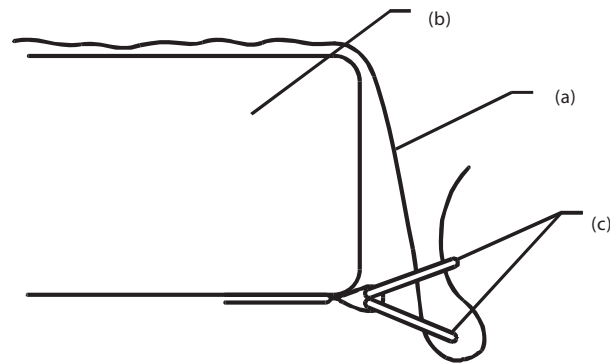

15. Plug the power cord into power source.

Note:

After the mattress power cord is plugged into a power source, if the controller is disconnected or not responding, the mattress will beeb to alert the user.

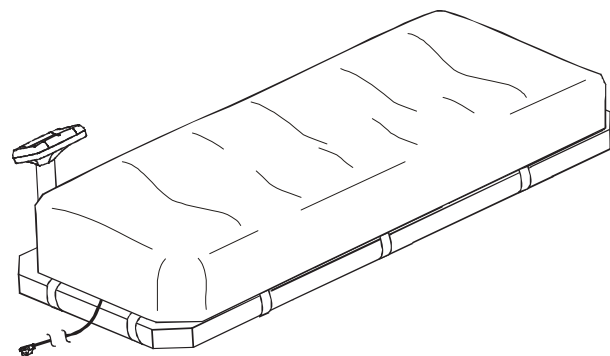

Setup Procedures

POWERING UP THE MATTRESS



WARNING

The mattress is equipped with a hospital grade plug for protection against shock hazard. It must be plugged directly into a properly grounded three-prong receptacle. Grounding reliability can be achieved only when a hospital grade receptacle is used.

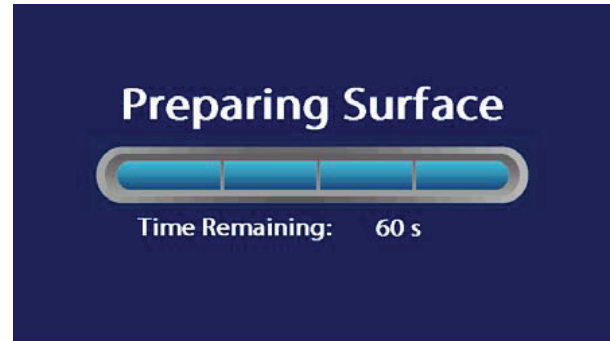

Plug the mattress power cord into a properly grounded, hospital grade receptacle.

The green LED on the controller will light whenever the power cord is plugged in.

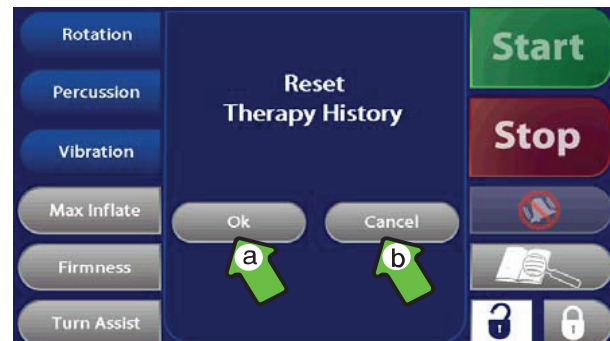

1. Select whether to reset tracking of the current therapy history.
 - a) To reset the current therapy history select  .
 - b) To continue to store the current therapy history in memory, select  .



2. Confirm whether to delete history or continue to store in memory.
 - a) To reset the current therapy history, select  .
 - b) To continue to store the current therapy history in memory, select  .

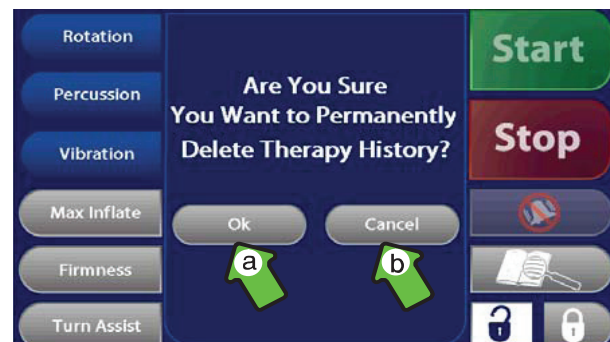

Setup Procedures

CONTROLLER BACKLIGHTING

The controller display back-lighting will come on and remain on for 30 minutes after initial power-up. After a period of non-use, the backlighting goes into stand-by mode. When the display is in stand-by, the mattress continues to function normally.

A single touch anywhere on the screen will turn the backlighting on.

The Status Screen indicates which therapies (if any) are currently active and the amount of therapy time remaining. Each therapy has a status indicator showing ON, OFF or PAUSED.

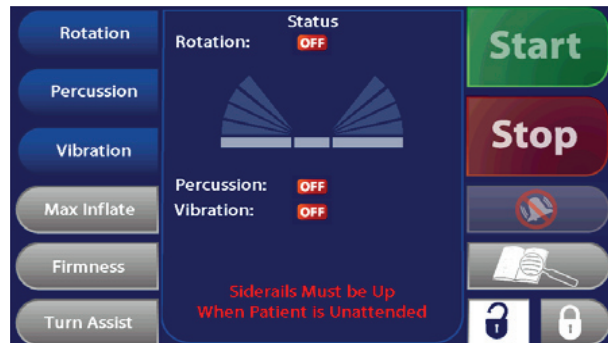

Note

- Backlighting remains on during all alarm conditions.
- Backlighting remains on during Percussion and Vibration sessions.
- Backlighting remains on for the first 30 minutes of a Rotation session.

Therapy Modes

Note

All references to right and left on the touch screen and throughout the manual refer to the right and left of a patient lying face up on the surface.

NORMAL THERAPY MODE

The normal therapy mode of the XPRT surface provides:

- Full-body pressure relief
- Low Air Loss
- A sloped gel heel section
- Adjustable firmness

ROTATION/PERCUSSION/VIBRATION THERAPY MODES

Routine turning is a standard of care for critically ill patients. Based on several published clinical studies, turning a patient improves lung function, reduces hospital acquired pneumonia and facilitates pulmonary secretions to prevent consolidation of fluids and pneumonia. Chest Percussion and Vibration therapies are used to loosen and mobilize secretions adhering to bronchial walls. Chest Percussion and Vibration therapies are also used to facilitate drainage or movement of pulmonary secretions. XPRT provides Percussion and Vibration therapies by rapidly increasing and decreasing the air pressure within fingerlike air cells located in the upper surface of the mattress. Both the amplitude and the frequency of the pulses in Percussion mode and the amplitude of the pulses in the Vibration mode can be specified with selections on the controller. Pulse rates ranging from 2 beats/second to 6 beats/second are available in the Percussion mode and a pulse rate of 10 beats/second is available in the vibration mode.

Contraindications for Rotation, Percussion and Vibration include, but are not limited to:

- Patients with acute spinal cord injury.
- Patients in skeletal traction.
- Patients with significant hemoptysis.
- Patients for whom a head-down position is contraindicated (e.g., those with a head injury).
- Patients with bleeding disorders.
- Patients with rib fractures, or predisposition to pathologic fractures.
- Patients for whom the techniques cause increased dyspnea or wheezing.
- Patients who are hemodynamically unstable.

Therapy Modes

PRESSURE RELIEF

The XPRT mattress provides pressure relief with tissue interface pressure readings below 32mmHg for patients under 295 pounds. For patients over 295 pounds, the XPRT mattress system provides pressure management.

LOW AIR LOSS (LAL)

XPRT provides continuous flow of air through the sleep surface. LAL assists with skin management by reducing heat and moisture build-up where skin contacts the mattress and bedding.

SLOPED HEEL SECTION

The sloped heel section reduces the tissue interface pressure on the heels by providing support to the calves and redistributing the heel pressure.

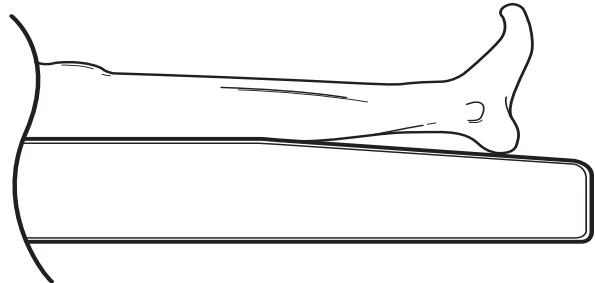

Operation Guide - Rotation Therapy

WARNING

Because injury could result, use of pulmonary therapy bed systems for stroke victims should be only under physician's order.

Do not rotate patients with unstable fractures, acute spinal cord injuries or those in skeletal traction. Serious injury could result.

Rotation angle settings approximate the degrees of rotation achieved by a 165 pound patient with an 18 inch shoulder width. The actual amount of rotation achieved is dependent on patient size, patient weight and shoulder width. Monitor the patient for at least one complete cycle to verify the unit achieves the desired angle.

Ensure that any and all tubing and wiring connected to the patient is long enough, stabilized, and secure to assure safe and unrestricted lateral rotation/elevation of the patient. Be sure to monitor the patient frequently.

To avoid injury, when using rotation or pulmonary therapy, take care not to extubate intubated patients.

To help ensure patient safety, always raise the bed siderails before beginning therapy.

To avoid possible injury and to assure proper operation when using the XPRT Therapy Mattress on a bed frame equipped with:

SCALES

- Follow the manufacturer's instructions for use of the scale system.
- Do not zero the bed scales or weigh patient with Percussion, Vibration, Rotation or Turn-Assist active. Patient motion and position resulting from the dynamic therapy mattress may adversely affect scale system performance.

BED EXIT SYSTEM

- Follow the manufacturer's instructions for use of the bed exit system.
- Do not initialize "Arm", bed exit with Percussion, Vibration, Rotation or Turn-Assist active. The patient motion and position resulting from the dynamic therapy mattress may adversely affect bed exit system performance.
- Confirm proper bed exit system operation when used in conjunction with Percussion, Vibration, Rotation and Turn-Assist.

Operation Guide - Rotation Therapy

TO PREPARE FOR ROTATION THERAPY

PATIENT POSITIONING

1. Position the patient along the centerline of the mattress.



 **WARNING**

Failure to position the patient along the mattress centerline before starting therapy could result in patient injury.



2. Align the patient's shoulders with the graphic indicator on the side of the mattress.



BED POSITIONING

1. Raise the bed siderails
2. Lower the bed height to the lowest practical position.
3. Lower the head section to flat or as low as possible.

Operation Guide - Rotation Therapy

TO START ROTATION THERAPY

1. Select **Rotation**.

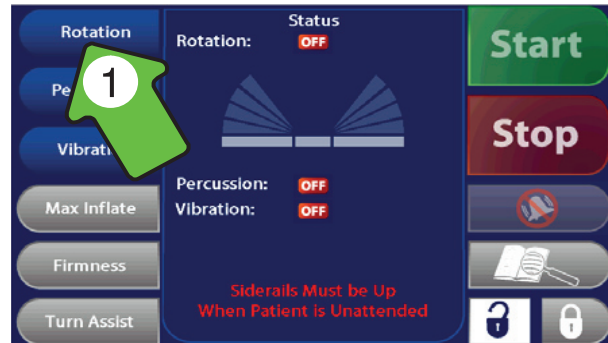

2. Adjust the therapy parameters as needed, then select **Start** -- Rotation starts.

- a) Increase or decrease patient right side rotation angle.
- b) Increase or decrease patient left side rotation angle.
- c) Increase or decrease patient right side rotation hold time (speed).
- d) Increase or decrease patient supine rotation hold time (speed).
- e) Increase or decrease patient left side rotation hold time (speed).
- f) Set rotation rate.
 - f1) Increase or decrease rotation rate.
 - f2) Select **Ok**.

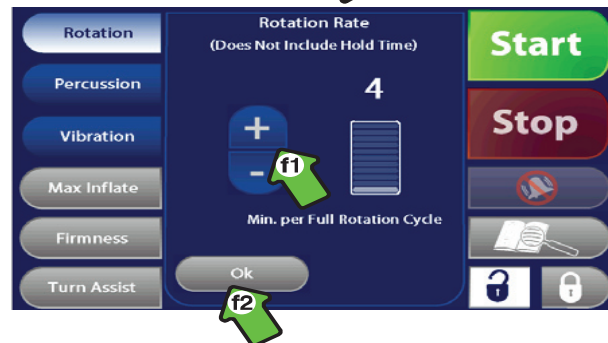
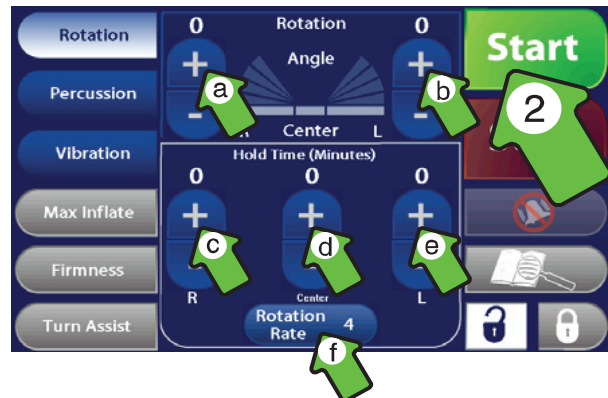

3. Verify the bed siderails are raised and the patient is centered on the mattress. Select **Confirm**.

Note

- The Rotation Therapy session continues until stopped or paused.
- All Therapy parameters are stored until changed or reset.
- To reset the parameters to the default values, see this section within "Operation Guide - Advanced Settings".



[Return To Table of Contents](#)

Operation Guide - Rotation Therapy



TO ADJUST THE ACTIVE THERAPY PARAMETERS

1. Select  .
2. Adjust the therapy parameters as described in step 2 of “To Start Rotation Therapy”.

Note

The adjusted parameters take effect as soon as they are changed.

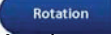
ADDITIONAL IMPORTANT INFORMATION

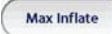
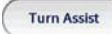
- If the angle of the head elevation is between 30 and 60 degrees, maximum rotation settings, other than Turn-Assist, are automatically reduced to ensure safe rotation levels. If the head angle is 60 degrees or greater,  is selected and  is selected. An alarm tone will sound to alert the caregiver and the message “Rotation Stopped Head Elevation Too High” is briefly displayed.
- If rotation is stopped for any reason, “Rotation” and “Stopped” are briefly displayed and the patient returns to the supine position.
- If Rotation is active and  or  is selected, the screen will display “Rotation Paused” then “Maximum Inflate” or the Turn Assist Screen will display.



TO STOP ROTATION THERAPY

1. Select  . The patient returns to the center position -- Rotation Stops.

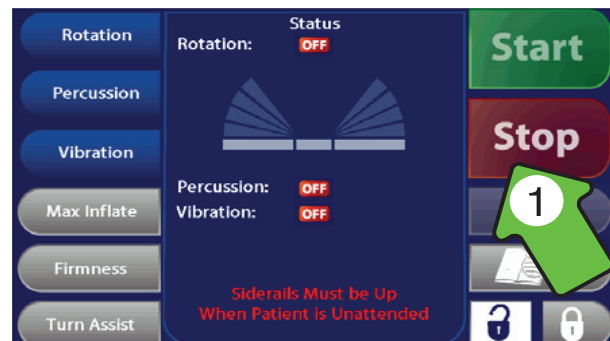

Operation Guide - Percussion Therapy

WARNING

To avoid possible injury and to assure proper operation when using the XPRT Therapy Mattress on a bed frame equipped with:

Scales

- Follow the manufacturer’s instructions for use of the scale system.
- Do not zero bed scales or weigh patient with Percussion, Vibration, Rotation or Turn-Assist active. Patient motion and position resulting from the dynamic therapy mattress may adversely affect scale system performance.

Bed Exit System

- Follow the manufacturer’s instructions for use of the bed exit system.
- Do not initialize “Arm” bed exit with Percussion, Vibration, Rotation or Turn-Assist active. The patient motion and position resulting from the dynamic therapy mattress may adversely affect bed exit system performance.
- Confirm proper bed exit system operation when used in conjunction with Percussion, Vibration, Rotation and Turn-Assist.

TO START PERCUSSION THE THERAPY

1. Select  .

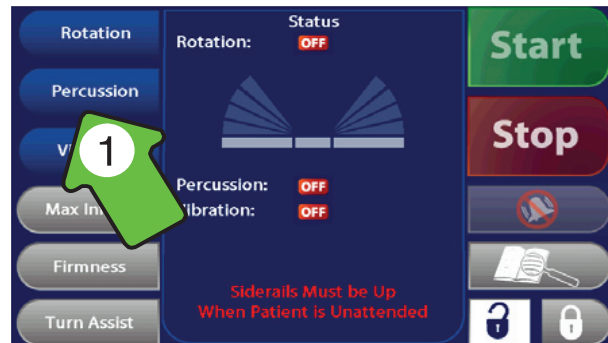

2. Adjust the therapy parameters as needed, then select  .
 - a) Increase or decrease the frequency of percussion.
 - b) Increase or decrease the duration of the therapy.
 - c) Select both lungs “bilateral” or either the left or the right lung to receive treatment.

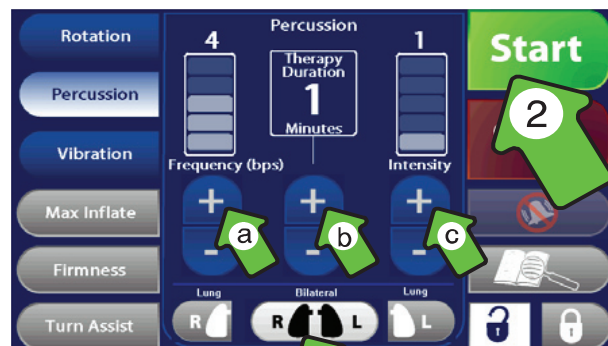

The screen will display “Percussion Started”. The screen will then display “Preparing Percussion” while the system is optimizing surface pressures for patient therapy.

Operation Guide - Percussion Therapy

TO ADJUST THE ACTIVE THERAPY PARAMETERS

1. Select **Percussion**.
2. Adjust the therapy parameter as described in step 2 of section "To Start Percussion Therapy".

NOTE

- The adjusted parameters take effect as soon as they are changed.
- To change lung selection, Percussion must be stopped.
- The percussion therapy session continues until the selected duration time is reached or until the session is stopped or paused.
- When restarting percussion therapy after the session was paused or stopped for more than 30 seconds, the screen will display two options: "Continue Previous Therapy Session" or "Start New Therapy Session".
- All therapy parameters are stored until changed or reset.
- To reset the parameter to the default values, see this section within "Operation Guide - Advanced Settings".
- The vibration therapy button is inactive while Percussion is active.

TO STOP PERCUSSION THERAPY

1. Select **Stop** -- Percussion stops.

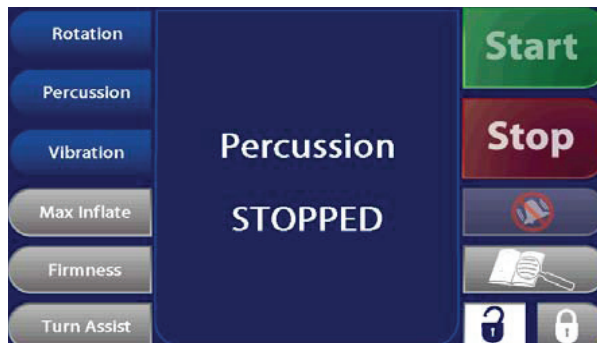
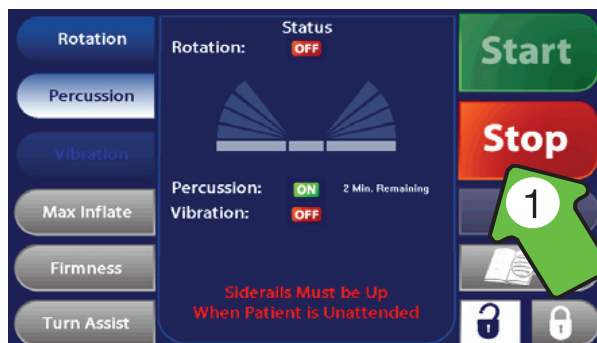

Operation Guide - Vibration Therapy

WARNING

To avoid possible injury and to assure proper operation when using the XPRT Therapy Mattress on a bed frame equipped with:

SCALES

- Follow the manufacturer's instructions for use of the scale system.
- Do not zero bed scales or weigh patient with Percussion, Vibration, rotation or Turn-Assist active. Patient motion and position resulting from the dynamic therapy mattress may adversely affect scale system performance.

BED EXIT SYSTEM

- Follow the manufacturer's instruction for use of the bed exit system.
- Do not initialize "Arm", bed exit with Percussion, Vibration, Rotation or Turn-Assist active. The patient motion and position resulting from the dynamic therapy mattress may adversely affect bed exit system performance.
- Confirm proper bed exit system operation when used in conjunction with Percussion, Vibration, Rotation and Turn-Assist.

TO START VIBRATION THERAPY

1. Select  .

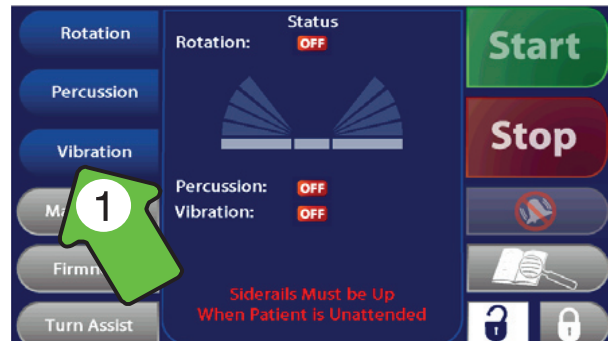

2. Adjust the therapy parameters as needed, then select  -- Vibration starts.
 - a) Increase or decrease the duration of the therapy.
 - b) Increase or decrease the intensity of the vibration.
 - c) Select both lungs (bilateral) or either the left or right lung to receive treatment.

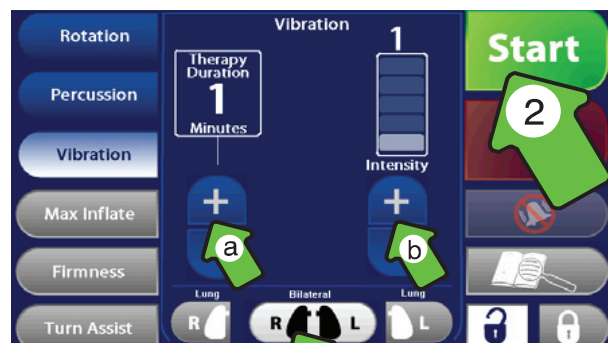

[Return To Table of Contents](#)

Operation Guide - Vibration Therapy

TO ADJUST THE ACTIVE THERAPY PARAMETERS

1. Select  .
2. Adjust the therapy parameter as described in step 2 of section “To Start Vibration Therapy”.

Note

- The adjusted parameters take effect as soon as they are changed.
- To change lung selection, Vibration must be stopped.
- The vibration therapy session continues until the selected duration time is reached or until the session is stopped or paused.
- When restarting vibration therapy after the session was paused or stopped for more than 30 seconds, the screen will display two options: “Continue Previous Therapy Session” or “start New Therapy Session”.
- All therapy parameters are stored until changed or reset.
- To reset the parameter to the default values, see this section within “Operation Guide - Advanced Settings”.
- The Percussion therapy button is inactive while Vibration is active.

TO STOP VIBRATION THERAPY

1. Select  -- Vibration stops.

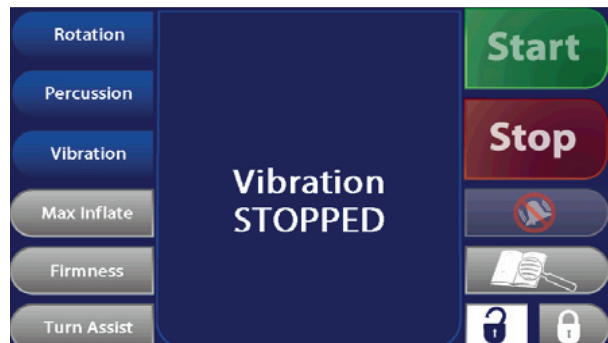
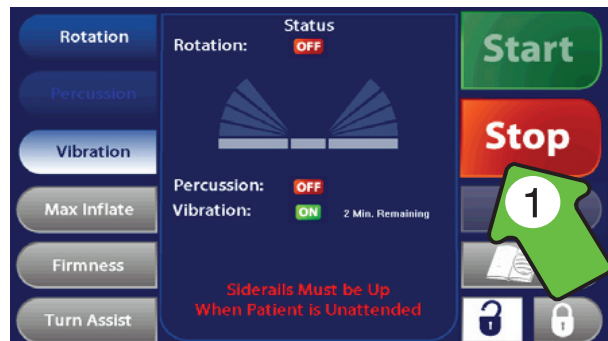

Operation Guide - Nursing Features

TO START MAX INFLATE

The Max Inflate mode inflates the air bladders to the maximum air pressure, creating a firm surface for patient repositioning, transfer, or CPR.

Select **Max Inflate** -- Max Inflate starts.

Note

- The Rotation, Percussion, Vibration, Firmness and Turn-Assist buttons are all inactive when Max Inflate is active.
- If Rotation, Percussion or Vibration are active when Max Inflate is selected, the therapy will pause and can be restarted by pressing **Start** after Max Inflate finishes or is stopped.

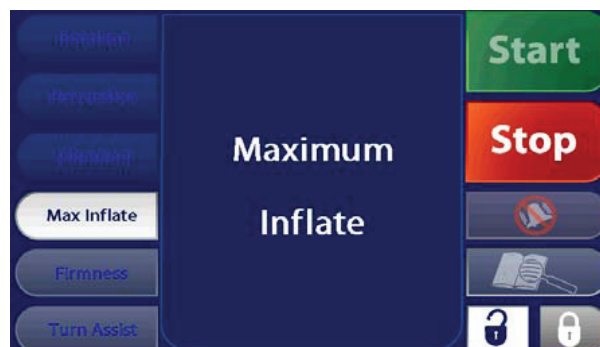
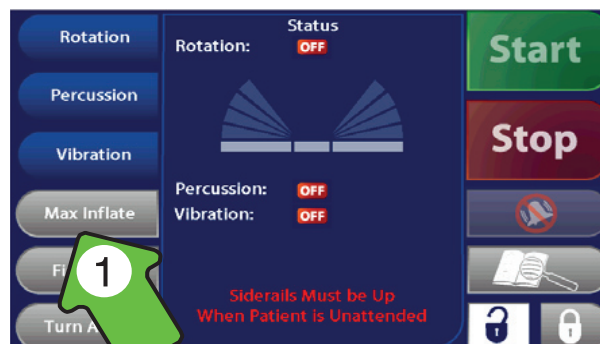

- After 30 minutes of continuous Max Inflate operation, an alarm sounds to alert the caregiver and the message "Maximum Inflate Has Reached Time Limit" is displayed and Max inflate stops and the system returns to the previous settings. **Start** must be pressed to resume therapy.



WARNING

Deflate the XPRT mattress system or use Max Inflate to inflate it completely before beginning CPR or CPR may be ineffective.

Operation Guide - Nursing Features

TO STOP MAX INFLATE

1. Select  -- Max Inflate stops.

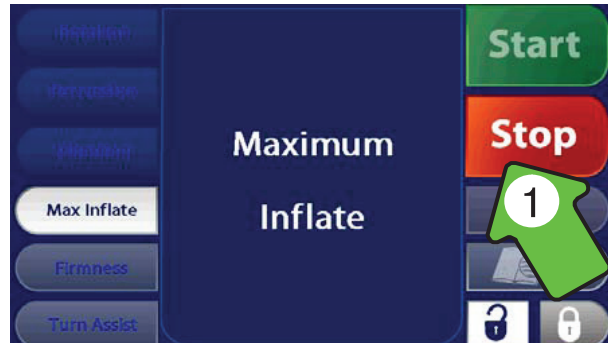

Note

- Rotation, Percussion and Vibration therapies are paused when Max Inflate is started. When Max Inflate is stopped, a prompt is briefly provided to continue or resume therapy.



Operation Guide - Nursing Features

TO ADJUST MATTRESS FIRMNESS

Mattress firmness settings may be adjusted for patient comfort requirements. The default value of 18 will provide optimal pressure relief for patients up to 220 pounds. For larger patients, higher settings are recommended.

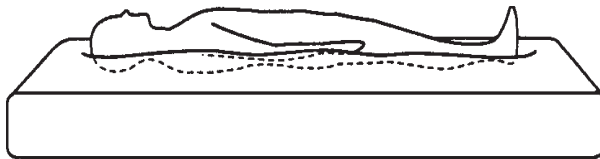

Correct Firmness Setting

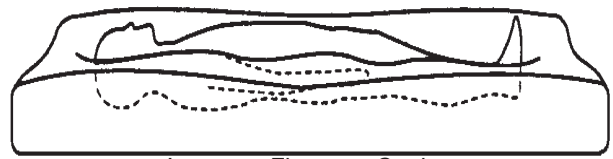

Incorrect Firmness Setting

1. With the patient in the supine position, select

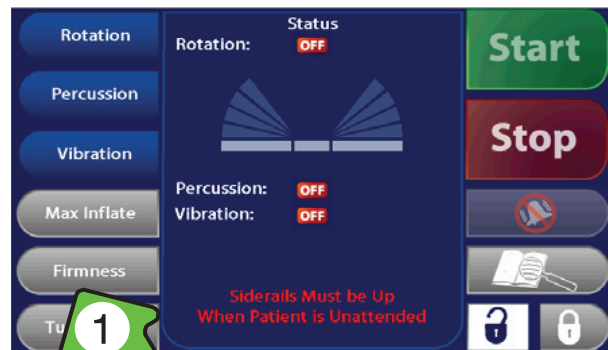

2. Adjust the settings as needed.

3. Select .

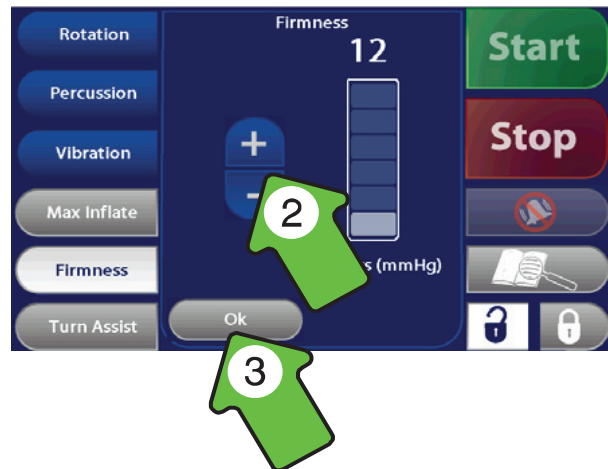

Operation Guide - Nursing Features

FLUOROSCOPY

An 18 x 20 fluoroscopy window is located to provide a view of the chest.

PATIENT POSITIONING

Align the patient's shoulders with the graphic indicator on the side of the mattress.



Operation Guide - Nursing Features

WARNING

To avoid possible injury and to assure proper operation when using the XPRT Therapy Mattress on a bed frame equipped with:

Scales

- Follow the manufacturer's instructions for use of the scale system.
- Do not zero bed scales or weigh patient with Percussion, Vibration, Rotation or Turn-Assist active. Patient motion and position resulting from the dynamic therapy mattress may adversely affect scale system performance.



Bed Exit System

- Follow the manufacturer's instructions for use of the bed exit system.
- Do not initialize "Arm" bed exit with Percussion, Vibration, Rotation or Turn-Assist active. The patient motion and position resulting from the dynamic therapy mattress may adversely affect bed exit system performance.
- Confirm proper bed exit system operation when used in conjunction with Percussion, Vibration, Rotation and Turn-Assist.

TO START TURN-ASSIST

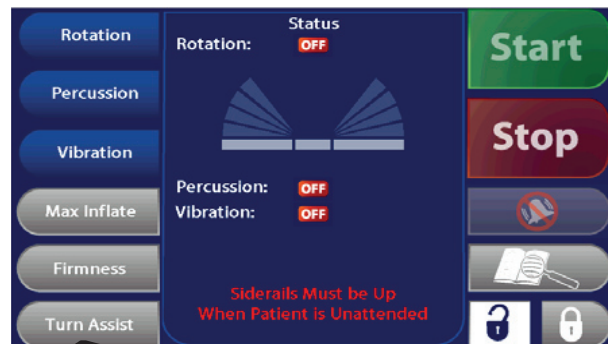
1. Select .



2. Select the direction to turn the patient.
 - a)  -- The patient's right side raises.
 - b)  -- The patient's left side raises.

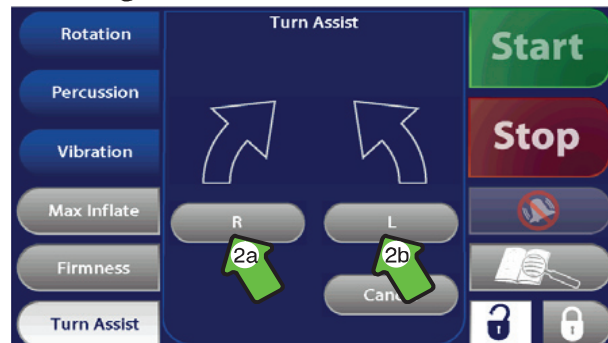

WARNING

Do not leave the patient unattended during Turn-Assist. Serious injury could result.

Note

- The Rotation, Percussion, Vibration, Max Inflate and Firmness buttons are all inactive when Turn-Assist is active.

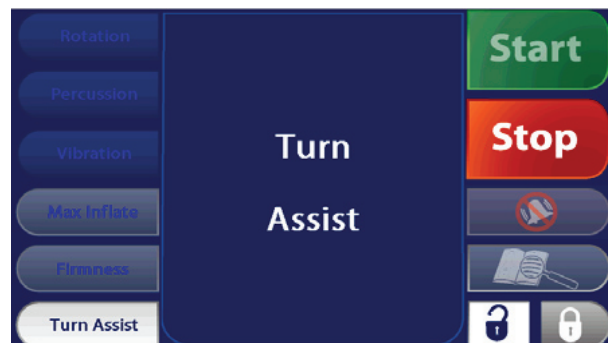

[Return To Table of Contents](#)

Operation Guide - Nursing Features

TO STOP TURN-ASSIST

Note

- After 30 minutes, an alarm sounds to alert the caregiver that the Turn-Assist time limit has been reached. Turn-Assist must be stopped or it will remain on.

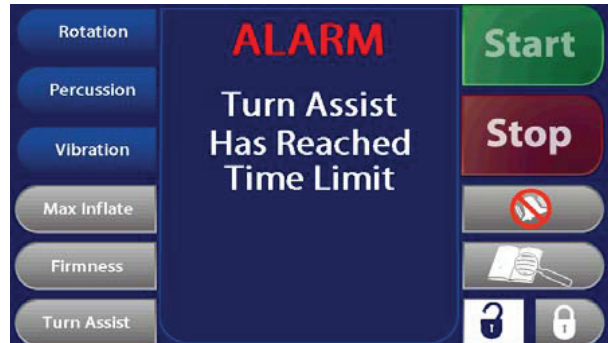

1. Select **Stop** -- Turn-Assist stops.

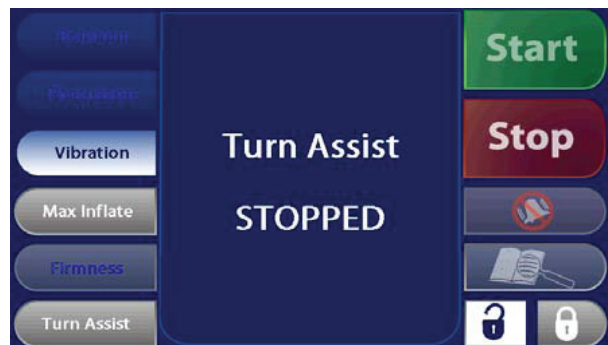

Note

- Rotation, Percussion and Vibration therapies are paused when Turn-Assist is started. When Turn-Assist is stopped, a prompt is briefly provided to continue or resume therapy.



Operation Guide - Nursing Features

TO SILENCE AN ALARM

1. Select . The message “Alarm Silenced for ‘X’ Minutes” will display for 3 seconds.

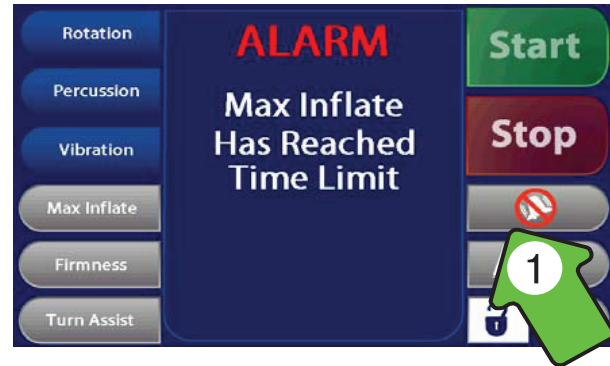

Note



- The current alarm is silenced for a period equal to the set alarm silence time. Refer to section “Operation Guide - Advanced settings”, “To Adjust the Input Volume and Alarm Settings” for instructions.
- If the alarm condition remains after the Alarm Silence time limit is reached, the alarm sounds and the appropriate alarm message is displayed.

Operation Guide - Nursing Features

TO LOCK ALL FUNCTIONS

1. Select  -- The message "Controls Locked" will briefly display.

Note

- If a therapy is running,  is not locked.
-  is not locked.
- If an Alarm condition occurs,  is not locked.

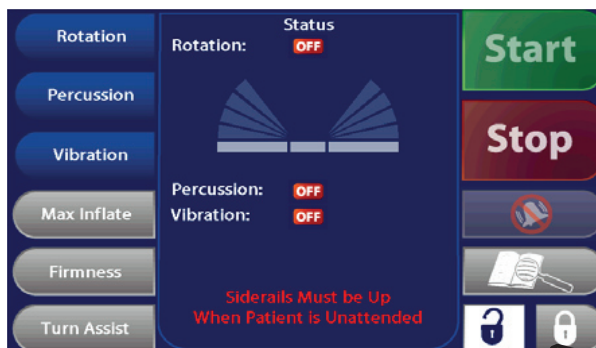

- When a locked button is selected, the message "Controls Locked" is displayed.

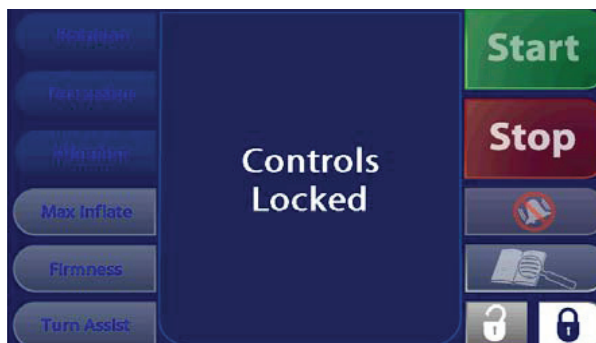

Operation Guide - Nursing Features

TO UNLOCK ALL FUNCTIONS

1. Select  . The message "Controls Unlocked" will briefly display.

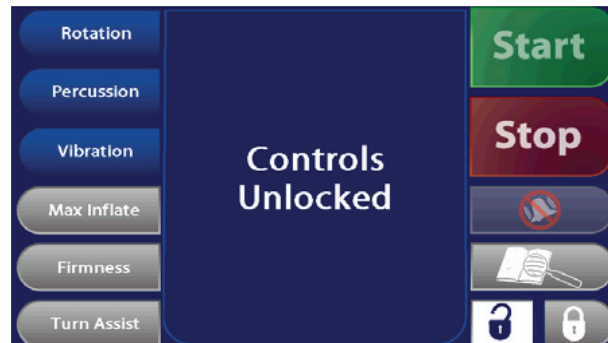
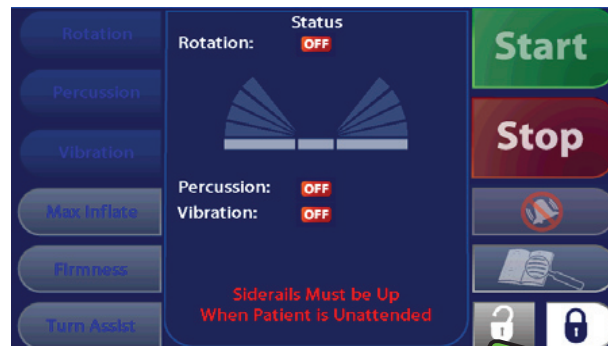

Operation Guide - Advanced Settings

TO CHANGE THE DISPLAYED LANGUAGE

1. Select  .

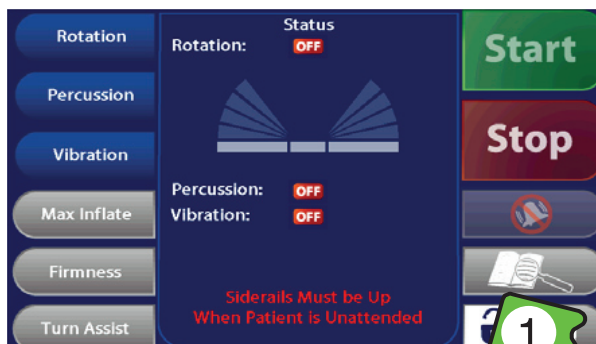

2. Select  to select French.

Note

- The selected language is active until another language is selected.
- The selected language is **not** reset when the “Reset Parameters” button is selected.

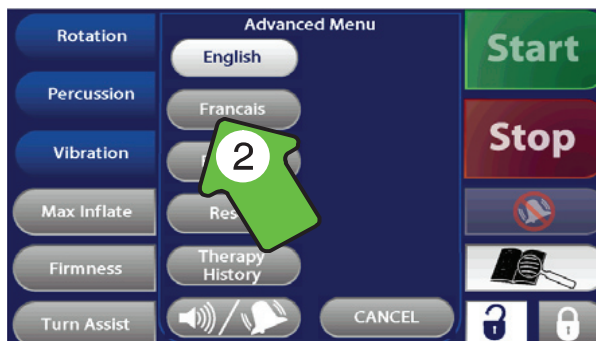

Operation Guide - Advanced Settings

TO CHANGE THE DISPLAYED LANGUAGE TO SPANISH

1. Select .



2. Select  to select Spanish.

Note

- The selected language is active until another language is selected.
- The selected language is **not** reset when the “Reset Parameters” button is selected.



Operation Guide - Advanced Settings

TO RESET THERAPY HISTORY

Reset Therapy History is used when a new patient is placed on the mattress. It resets the system's 12 to 24 hour records of Rotation, Percussion, and Vibration sessions.

1. Select  .

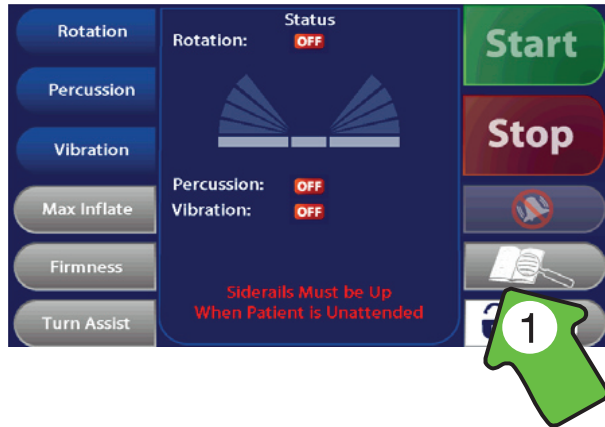

2. Select  .

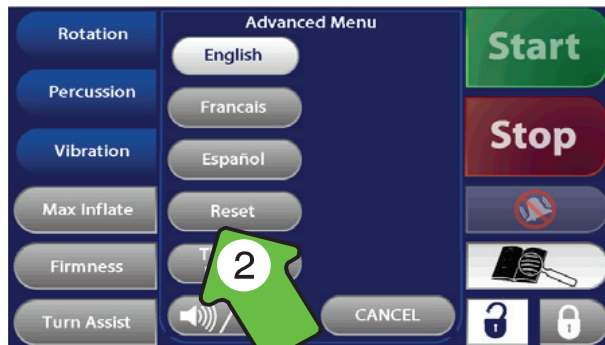

3. Select  .

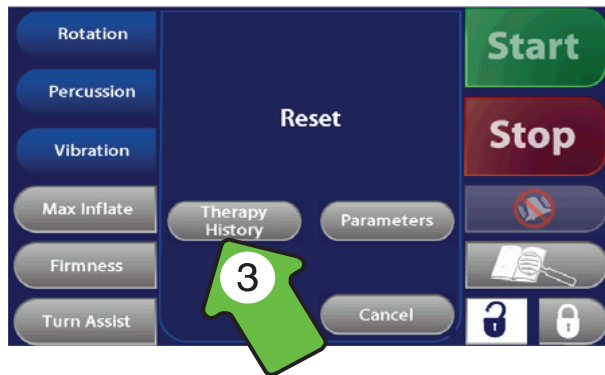

4. Select  -- current therapy history is erased and reset to zero.

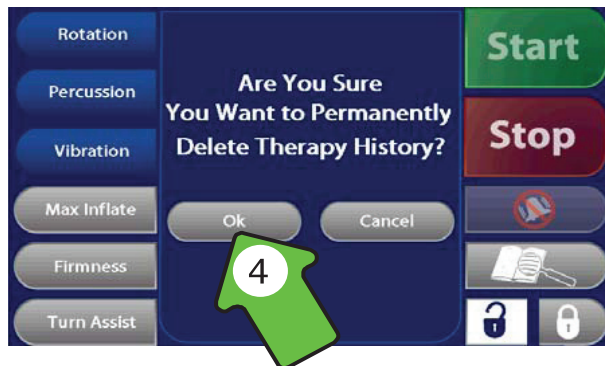

Operation Guide - Advanced Settings

TO RESET PARAMETERS TO DEFAULT

Selecting “Reset Parameters” returns the Rotation angles and hold times, Percussion/Vibration intensity, duration, frequency and lung selection, mattress firmness level and the alarm silence timer to the system default settings.

1. Select  .



2. Select  .



3. Select  .

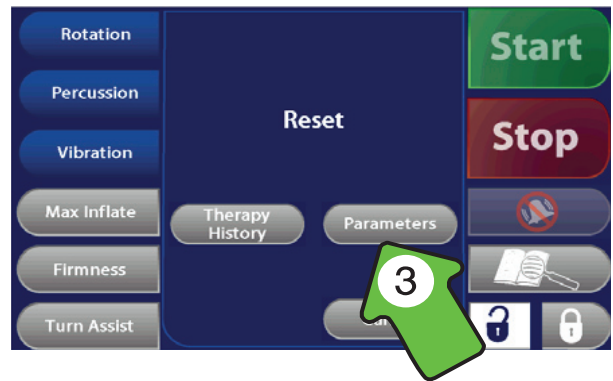

4. Select  . -- this resets all therapy parameters to the default settings.

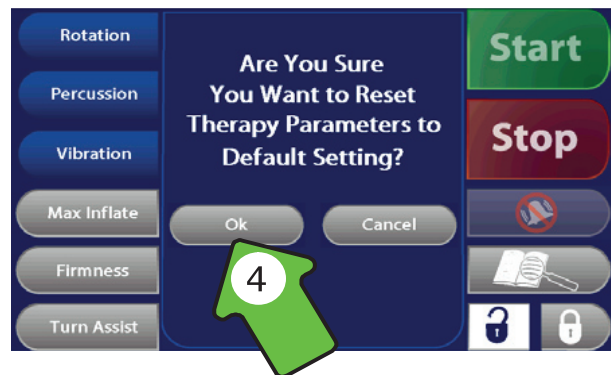

Note

- The selected language and alarm tones are **not** reset.

[Return To Table of Contents](#)

Operation Guide - Advanced Settings

TO VIEW THERAPY HISTORY

1. Select  .



2. Select  .

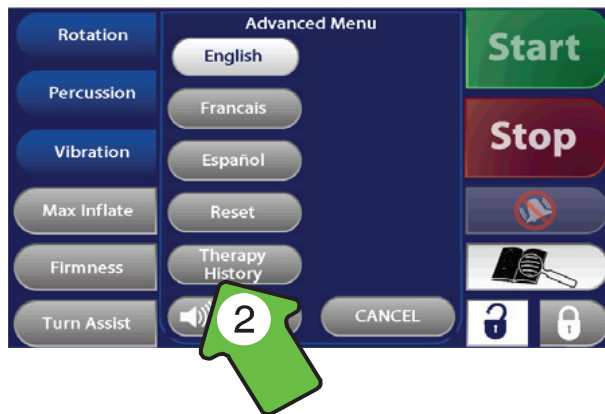

Note

- The Therapy History screen is displayed for 60 seconds.



Operation Guide - Advanced Settings

TO ADJUST THE INPUT VOLUME AND ALARM SETTINGS

1. Select  .

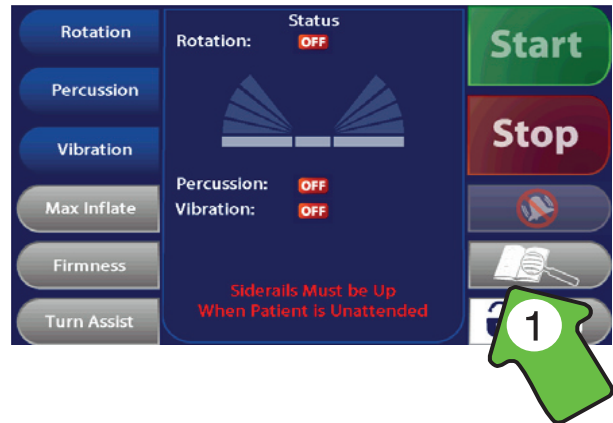

2. Select  .

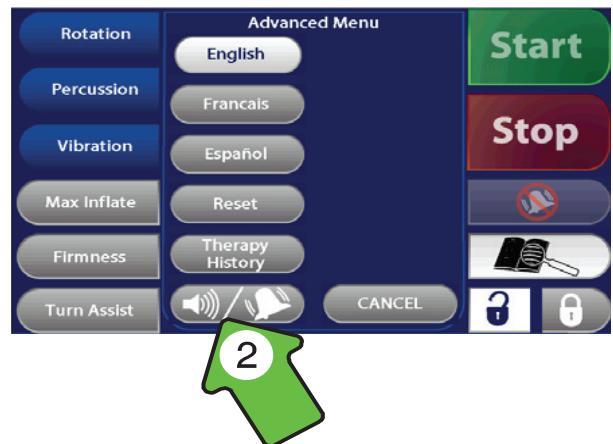

3. Select  .

- Adjust the volume of the input tones (audible feedback to screen touches)
- Select the desired alarm tone.
- Adjust the time the alarm is silenced when  is selected.



Note

- The selected alarm tones sounds when the alarm button is released.
- The alarm remains at full volume at all times.

Operation Guide - CPR

CPR ACTIVATION

WARNING

Deflate the XPRT mattress system or use Max Inflate to inflate it completely before beginning CPR or CPR may be ineffective. Refer to section “Operation Guide - Nursing Features”, “To Start Max Inflate” for instructions.

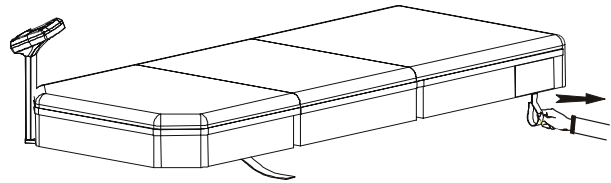

To activate CPR, pull either the left, right or both cords located at the head end of the mattress. All running functions will stop and an alert tone will sound.

If the left CPR cord is pulled, an alert tone will sound to notify the caregiver and the display will read “Left CPR Activated” until the plug is replaced.

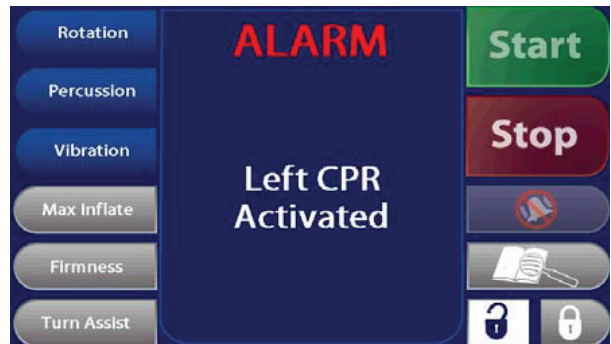

If the right CPR cord is pulled, an alert tone will sound to notify the caregiver and the display will read “Right CPR Activated” until the plug is replaced.

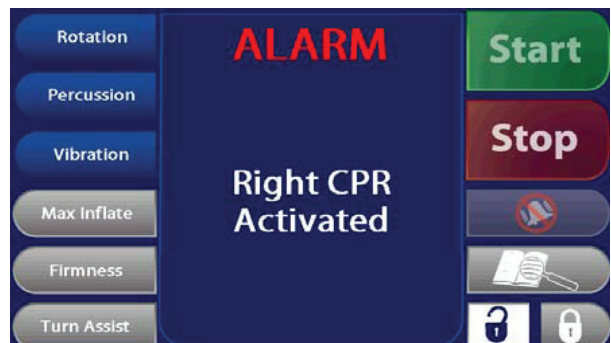
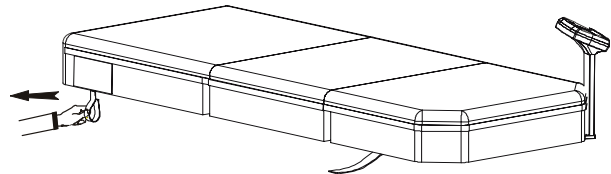

Operation Guide - CPR

CPR ACTIVATION (CONT'D)

If both CPR cords are pulled, an alert tone will sound to notify the caregiver and the display will read "Left CPR Activated" and "Right CPR activated" until the plug is replaced.

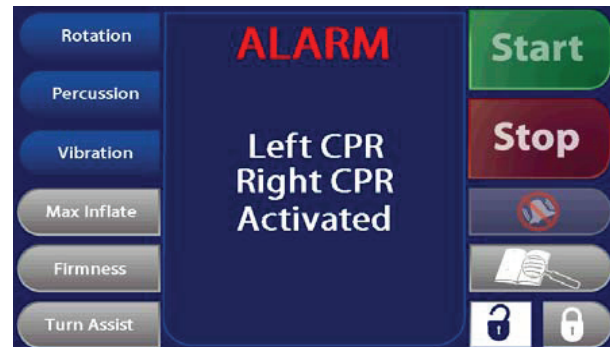

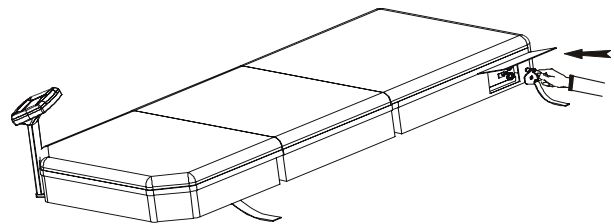

To end CPR and resume therapy, replace the CPR plug(s). Be sure the CPR plugs are fully engaged and snap into the locking mechanism.

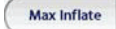

Nursing Care

TRANSFERING A PATIENT TO THE XPRT MATTRESS

1. Select  . Refer to “Operation Guide - Nursing Features”, “To Start Max Inflate” for instructions.
2. Adjust the height of the bed to the same level as the surface from which the patient is being transferred.
3. Lock the brakes on both surfaces. Lower the siderails.
4. Transfer the patient following all applicable safety rules and institution protocols to ensure patient and caregiver safety.
5. Position the patient along the centerline of the mattress.
6. Select  to turn off Max Inflate.



WARNING



Failure to position the patient along the mattress centerline before starting therapy could result in patient injury.



7. Align the patient’s shoulders with the graphic indicator on the side of the mattress.
8. Raise and lock the siderails.

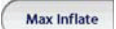

TRANSFERING A PATIENT FROM THE XPRT MATTRESS

1. Select  Refer to “Operation Guide - Nursing Features”, “To Start Max Inflate” for instructions.
2. Adjust the height of the bed to the same level as the surface to which the patient is being transferred.
3. Lock the brakes on both surfaces. Lower the siderails.
4. Transfer the patient following all applicable safety rules and institution protocols to ensure patient and caregiver safety.
5. Select  to turn off Max Inflate.

Nursing Care

TRANSPORTING A PATIENT ON THE BED

1. Discontinue any active therapy modes and return the patient to the supine position.
2. Unplug the mattress power cord and the bed power cord from the wall outlet and properly stow them to avoid entanglement during transport.
3. Raise and lock the siderails.
4. Transport the patient following all applicable safety rules and institution protocols to ensure patient and caregiver safety.
5. Plug the mattress power cord and the bed power cord into properly grounded, hospital grade wall receptacles when the patient's destination is reached.

Note

- The mattress will automatically maintain air pressure for up to four hours.

Nursing Care

SKIN CARE GUIDELINES

- Remove excess moisture from the mattress surface. Always keep the patient's skin clean and dry.
- Maintain proper air pressures. (Refer to "Operation Guide - Nursing Features" -- "To Adjust Mattress Firmness").
- Monitor the patient's skin condition regularly, especially in areas where moisture may occur, i.e. incontinence or drainage conditions. Consult a physician if erythema or skin breakdown occurs.

BATHING A PATIENT

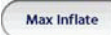
1. Select  to fully inflate the mattress. (Refer to "Operation Guide - Nursing Features" -- "To Start Max Inflate" for instructions).
2. Level the bed and adjust the bed height to facilitate access to the patient.
3. Lower the siderail on the caregiver's side of the bed.

WARNING

Do not allow liquid to pool on the mattress or pump box. Immersion or liquid pooling could cause malfunction resulting in equipment damage or patient injury.

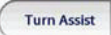
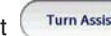
4. Bathe, rinse and dry the patient's anterior.
5. Select  to roll the patient onto his/her side. (Refer to "Operation Guide - Nursing Features" -- "To Start Turn-Assist" for instructions).
6. Bathe, rinse and dry the patient's exposed side and posterior.
7. Select  to roll the patient onto his/her opposite side. (Refer to "Operation Guide - Nursing Features" -- "To Start Turn-Assist" for instructions).
8. Bathe, rinse and dry the patient's exposed side.
9. Return the patient to the center position.
10. Position the patient along the center line of the mattress.
11. Ensure that the bottom sheet is dry.



WARNING

Failure to position the patient along the mattress centerline before starting therapy could result in patient injury.



12. Align the patient's shoulders with the graphic indicator on the side of the mattress.
13. Raise and lock the siderails.



Nursing Care

INCONTINENCE / DRAINAGE

Disposable diapers or incontinence pads may be used. However, using too many layers between the patient's skin and the mattress will reduce the effectiveness of the pressure-relieving capabilities of the system.

Watch for incontinence or drainage and provide appropriate skin care following each episode.

WARNING

It is the responsibility of the caregiver to monitor the patient's condition safety. Consult physician if erythema or skin breakdown occurs.

Preventative Maintenance Checklist

- _____ Zipper and cover are free of tears, cuts, holes or other openings.
- _____ Pendant and touch-screen operate properly.
- _____ Percussion therapy functioning properly (refer to “Operation Guide - Percussion Therapy”).
- _____ Vibration therapy functioning properly (refer to “Operation Guide - Vibration Therapy”).
- _____ Rotation therapy functioning properly (refer to “Operation Guide - Rotation Therapy”).
- _____ Max Inflate functioning properly (refer to “Operation Guide - Nursing Features” -- “Max Inflate”).
- _____ Turn-Assist functioning properly (refer to Operation Guide - Nursing Features” -- “Turn-Assist”).
- _____ Left and right CPR releases work properly (refer to “Operation Guide -CPR”).
- _____ Service log shows no errors (refer to “Service Screen” and “Service Code” sections).
- _____ Running system diagnostics produces no errors (refer to “Service Screen” and “Service Code” sections).
- _____ For units with very heavy percussion or vibration use (multiple treatments daily): percussion diaphragms are free of excessive wear (i.e. cracks). Replace, if necessary.
- _____ All electrical connections tight.
- _____ Power cord and plug are free of damage.
- _____ Current leakage not more than 300 microamps.
- _____ Foam/air cells are free of excessive wear (ie cracks). Recommend checking cells every 6 months.
- _____ Replace, if necessary.

Mattress Model and Serial No.

Model	Serial No.

Completed by: _____ Date _____

Note

A preventative maintenance program should be established and performed at a minimum of annually. Preventative maintenance may need to be performed more frequently based on the usage level of the product.

Cleaning

WARNING

Unplug the mattress power cord from the wall outlet before cleaning the mattress. Failure to unplug the unit could cause equipment damage or personal injury.

Do not immerse the mattress or foot box in cleaning or disinfectant solutions. Do not allow liquid to pool on the mattress or foot box. Immersion or liquid pooling could cause malfunction resulting in equipment damage or patient injury.

PENDANT CLEANING

To clean the pendant, use a non-abrasive cleaning solution (i.e. warm, soapy water) and a clean, soft cloth. Apply disinfectant such as a 10% household bleach solution to the entire controller outer surface.

MATTRESS CLEANING

Wipe down the entire mattress surface with a mild soap and water solution and a clean, soft cloth. Apply a disinfectant such as 10% household bleach solution to the entire mattress outer surface. Lift up the foot section of the mattress to clean the bottom surface.

To clean the bottom of the head section of the mattress, carefully lift up the head section and fold it over the seat section. Clean as described above. Allow the surface to completely dry then gently lower the head section back in place.

CAUTION

Do not drop the head section of the mattress back onto the bed frame. Abrupt dropping of the mattress head section could damage the controls, causing malfunction resulting in equipment damage or patient injury.

Allow the mattress to completely dry. Wipe down all surfaces with a clean, dry cloth to remove any excess moisture.

The mattress cover must be completely dry before storage or adding linens. Failure to remove excess disinfectant could cause degradation of the cover material.

Note

The mattress cover contains an antimicrobial agent to help prevent bacteria and fungus from destroying the cover. If stains, discoloration, brittleness, stickiness or unpleasant odors become noticeable, the antimicrobial agent may have become ineffective and the mattress cover should be replaced.

FOOT BOX CLEANING

To clean the foot box, use a non-abrasive cleaning solution (i.e. warm, soapy water) and a clean, soft cloth. Apply disinfectant such as 10% household bleach solution to the entire box outer surface.

WARNING

Allow the foot box to completely dry before placing the mattress over it. Excess moisture could cause equipment malfunction resulting in equipment damage or patient injury.

Troubleshooting Guide

Problem / Failure	Recommended Action
<p>Mattress has no power.</p>	<p>A. Verify the mattress power cord is connected properly. 1) If not, reconnect. If the mattress now has power, return it to service.</p> <p>B. Listen for the head box alarm. 1) If no alarm is sounding, go to step C. 2) If the alarm is sounding, lift up the foot section of the mattress, unplug the mattress power cord from the power source, and verify the black connector at the foot box is connected properly to the controller. Plug the mattress power cord back into the power source. If the mattress now has power, return it to service.</p> <p>C. Check the fuses above the foot box power cord connection. 1) Replace the fuse(s) and test. If the mattress now has power, return it to service.</p> <p>D. Check the power board. 1) Check the main fuse. Replace, if necessary. 2) Check for 120 VAC on the gray terminal block in the pump box assembly between the blue and brown wires from the power inlet filter. a) If no voltage, check for 120 VAC on the power cord inlet between the blue and brown wires. b) If voltage is present, replace the power inlet filter.</p> <p>E. Check DC voltages on the power board on connector J3, pin 7 (ground) / pin 8 (-5) / pin 9 (+26) / pin 10 (+12) 1) If no voltage at any one of the points, check for 26 VAC on connector J2. If no voltage, replace the transformer. 2) If no voltage at any one of the points, replace the power board. If the mattress now has power, return it to service.</p>
<p>Pendant has no power but the mattress is running and the head box is alarming.</p>	<p>A. Lift up the foot section of the mattress, unplug the mattress power cord from the power source and verify the black connector at the foot box is connected properly to the pendant. Reconnect if necessary. Plug the mattress power cord back into the power source. If the mattress now has power, return it to service. Check the red connector for being properly plugged in.</p> <p>B. If it is connected properly, test with another controller. Refer to Pendant Troubleshooting. If the pendant has power, return the mattress to service.</p>

Troubleshooting Guide

Problem / Failure	Recommended Action
Pendant is displaying “Preparing Surface” and will not let you get to the service screen.	A. Check for an air leak in system and repair if found.
Mattress will not inflate.	<p>A. Check the pendant for any alarm messages. 1) Access the service screen and look at the error log. Resolve any issues listed. If the mattress will now inflate, return it to service.</p> <p>B. Listen to the foot box and verify the pump is running. 1) If it is not, verify both the left and the right CPR plugs are properly inserted and snapped in the locking mechanism. If the mattress will now inflate, return it to service. 2) If the foot box pump is running, verify the main air hose is connected at the foot box and verify there are no kinks in the hose. If the mattress will now inflate, return it to service.</p>
Pendant does not respond.	<p>A. If the display backlight is on, go to step D.</p> <p>B. If the display backlight is not on, reference the troubleshooting section for mattress has no power.</p> <p>C. If the mattress has power, check for 12 VDC on the power board J5 between pin 3 (white/orange) and pin 4 (orange/white). 1) If voltage is present, go to step D. 2) If no voltage, replace the transformer. If the controller now responds, return the mattress to service.</p> <p>D. Test with another controller, if available. 1) If the different controller works, go to step E. 2) If the different controller still doesn't respond, open the head box and see if the CAN bus LED's are flashing on the CPU board. a) If the CAN LED's are not flashing, do a continuity check on the communication cable between the foot box and the head box or replace the CPU board in the head box. b) If the CAN LED's are flashing, replace the CPU board. If the controller now responds, return the mattress to service.</p> <p>E. Open the non-responding controller and check all the connections. 1) Reseat the connectors, if necessary, and test. 2) Inspect for damage. 3) If the controller now responds, return the mattress to service.</p>

Troubleshooting Guide

Problem / Failure	Recommended Action
Bladder won't inflate or deflate.	<p>A. Check the solenoid's in the head box RS, LS, RP, and LP to measure approximately 110 ohms. 1) Replace if reading is not approximate.</p> <p>B. Check the selector valve in the head box RR and LR to measure approximately 1100 ohms. 1) Replace if reading is not approximate.</p>

Quick Reference Replacement Parts List

Note

The parts and accessories listed on this page are all currently available for purchase. Some of the parts identified on the assembly drawing parts in this manual may not be individually available for purchase. Please call Stryker Customer Service USA: 1-800-327-0770 (Option 2), Canada: 1-888-233-6888 for availability and pricing.

Part Name	Part Number
Board, Main PCP (In Headbox)	2950-001-223
Board, Power Supply	2950-001-116
Cover, Bottom	2950-001-401
Cover, Top (Dartex)	2950-001-402
Cover, Top (Nylon)	2950-001-403
Hand Pendant Assembly	2950-047-000
Hand Pendant, Cable	2950-001-804
Hand Pendant, Display Assembly	5400-050-060
Kit, Bladder (Includes all Bladders, Hoses and Fittings)	2950-700-002
Kit, Foot Box Retainer (To Use on ICU)	2950-700-001
Mattress Extender (To Use on ICU)	2950-100-000
Power Cord, 3 foot (Used for Litter Mounted Optional 110V Outlet)	2950-001-426
Power Cord, 15 foot	2950-001-425
Pump	2950-001-105
Stepper Motor / Rotary Valve Assembly	2950-001-230

Service Information

TOP COVER REPLACEMENT

1. Unplug the mattress power cord from the power source.
2. Unzip the mattress cover at the patient's right side midsection and remove.
3. Line up the new cover zipper with the bottom cover zipper and zip them together.

FOOT BOX PUMP REPLACEMENT

Required Tools:

- Phillips Screwdriver
 - Needle Nose Pliers
 - Diagonal Pliers
1. Unplug the mattress power cord from the power source.
 2. Fold the foot section of the mattress back over the head section.
 3. Using a Phillips screwdriver, remove the seven screws holding the cover on the foot box.
 4. While holding the pump with one hand, carefully pull on the air hose to remove it from the barbed fitting.
 5. Using diagonal pliers, carefully cut the cable tie holding the power wires to the mounting post and unplug the connector from the logic board.
 6. Remove the four springs from the mounting posts.
 7. Remove the pump from the foot box.
 8. Using needle nose pliers, remove the four springs from the mounting bracket.
 9. Install the springs on the mounting bracket of the new pump and put the new pump into the foot box.
 10. Reattach the springs to the mounting posts.
 11. Connect the pump power connector to the logic board. Leave enough slack to allow free movement of the foot box to help prevent pinching of the cable.
 12. Use a new cable tie to hold the power wires to the mounting post.
 13. Reconnect the air hose to the barbed fitting on the new pump.
 14. Plug the mattress power cord into the power source and test the mattress functionality before returning the mattress to service.

Service Information

FOOT BOX POWER BOARD REPLACEMENT

Required Tools:

- Phillips Screwdriver
 - ESD System (Static Strap)
1. Unplug the mattress power cord from the power source.
 2. Fold the foot section of the mattress back over the head section.
 3. Using a Phillips screwdriver, remove the seven Phillips head screws holding the cover to the foot box assembly and remove the cover.
 4. Properly ground yourself.
 5. Unplug the cable connections from the power board. Note the locations so the new power board will be connected properly.
 6. Using a Phillips screwdriver, remove the six screws holding the power board to the foot box assembly.
 7. Remove the power board.
 8. Reverse the procedure to install the new power board.
 9. Plug the mattress power cord into the power source and test the mattress functionality before returning the mattress to service.

FOOT BOX TRANSFORMER REPLACEMENT

Required Tools:

- Phillips Screwdriver
 - ESD System (Static Strap)
 - Small Regular Screwdriver
1. Unplug the mattress power cord from the power source.
 2. Fold the foot section of the mattress back over the head section.
 3. Using a Phillips screwdriver, remove the seven Phillips head screws holding the cover to the foot box assembly and remove the cover.
 4. Properly ground yourself.
 5. Using a small regular screwdriver, unplug the cable connections from the junction block. Note the locations so the new transformer will be connected properly.
 6. Using a Phillips screwdriver, remove the screw from the bottom of the foot box securing the transformer to the foot box assembly.
 7. Remove the transformer and discard.
 8. Reverse the procedure to install the new transformer.
 9. Plug the mattress power cord into the power source and test the mattress functionality before returning the mattress to service.

Service Information

HEAD BOX CPU BOARD REPLACEMENT

Required Tools:

- Phillips Screwdriver
 - ESD System (Static Strap)
1. Unplug the mattress power cord from the power source.
 2. Unzip the mattress cover from the patient's left side of the mattress to the patient's right side.
 3. Unplug the left or right CPR cord to deflate mattress.
 4. Using the lift handle in the center of the bottom cover at the head, pull the head mattress towards the foot end.
 5. Pull the bottom cover towards the head exposing the head box.
 6. Using a Phillips screwdriver, remove the six screws securing the head box top cover and remove the cover.
 7. Grasp each of the five pressure sensor hoses closest to the sensor and unplug the hoses. Note the locations. Each hose has a number on it that corresponds with a number on the CPU board.
 8. Unplug the cable connections from the CPU board. Note the locations so the new CPU board will be connected properly.
 9. Using a Phillips screwdriver, remove the eight screws securing the CPU board to the head box. Remove the board.
 10. Reverse the procedure to install the new CPU board.
 11. Plug the mattress power cord into the power source and test the mattress functionality before returning the mattress to service.

HEAD BOX DIAPHRAGM AND SLIP DISC REPLACEMENT

Required Tools

- Phillips Screwdriver
 - Torque Driver
1. Unplug the mattress power cord from power source.
 2. Unzip the mattress cover from the patient's left side.
 3. Unplug the left or right CPR cord to deflate mattress.
 4. Using the lift handle in the center of the bottom cover at the head, pull the head mattress towards the foot end.
 5. Pull the bottom cover towards the head exposing the head box.
 6. Remove the six screws securing the head box top cover and remove the cover.
 7. Remove the four screws holding the percussion motor bearing caps.
 8. Remove the six screws from the diaphragm clamp, both sides.
 9. Remove 2 locknuts to disassemble connecting rod and diaphragm support plates, both sides.
 10. Remove existing slip discs and diaphragms and replace with new ones.
 11. Hand tighten 2 locknuts to loosely hold new diaphragm and slip disc to connecting rod and diaphragm support plate, both sides. Do Not Tighten At This Time.
 12. Secure sensor bracket and shaft assembly to right cylinder assembly with bearing block with 7-9 lbf.in.
 13. Secure shaft assembly to left cylinder assembly with bearing block with 7-9 lbf.in.
 14. Secure diaphragm support plate screws (6) with 7-9 lbf.in, both sides.
 15. Rotate shaft assembly so diaphragms are at bottom dead center so all creases and twists are removed from diaphragms. Secure locknuts (2) on support plate with 17-21 lbf.in, both sides.
 16. Reassemble mattress using steps 1-5 in reverse order.

Service Information

HEAD BOX STEPPER MOTOR / ROTARY VALVE ASSEMBLY

Required Tools:

- Phillips Screwdriver
 - 5/16" Nut Driver
1. Unplug the mattress power cord from power source.
 2. Unzip the mattress cover from the patient's left side of the mattress to the patient's right side.
 3. Unplug the left or right CPR cord to deflate mattress.
 4. Using the lift handle in the center of the bottom cover at the head, pull the head mattress towards the foot end.
 5. Pull the bottom cover towards the head exposing the head box.
 6. Using a Phillips screwdriver, remove the six screws securing the head box top cover and remove the cover.
 7. Unplug the stepper motor cable from the CPU board from connector TB10 and untie the two quick ties securing the cables to the rest of the cables.
 8. Hold the rotary valve assembly together while unplugging one hose at a time and plugging it in to the new valve into the same locations, repeat on all five hoses. Using a 5/16" nut driver, remove the three nuts securing the stepper motor / rotary valve assembly to the head box and remove.
 9. Install the new stepper motor / rotary valve assembly and reverse the steps. Perform a diagnostics test and verify the mattress is functioning properly with no alarms or errors.

Service Information

CELL ASSEMBLY REPLACEMENT KIT

Required Tools:

- Tubing Cutter
- Rubbing Alcohol

1. Unplug the mattress power cord from the power source.
2. Unzip top cover (counter-clockwise) and remove.
3. Cut spiral tubing just above 900 fitting from head box, four places. Refer to Figure 1.



Figure 1

4. Remove existing 900 fittings from head box and replace with new 900 fittings, four places. Refer to Figure 2 for orientation.



Figure 2

Service Information

5. Fold back head end of mattress as shown in Figure 3.

Note:

Two people required to fold back foam crib and head box.



Figure 3

6. Cut tubing just above 90 degree fitting from the head box; two places. Refer to Figure 4.



Figure 4

7. Remove existing 90 degree fittings from head box and replace with new 90 degree fittings, two places. Refer to Figure 5 for orientation.



Figure 5

8. Return head end mattress back to original flat position.
Note: Two people required to return mattress to original flat position.

Service Information

9. Unsnap cell-retaining strap from cell assembly near foot end as shown in Figure 6.
10. Remove Cell Assembly.



Figure 6

INSTALLATION OF NEW CELL ASSEMBLY

1. Place new cell assembly on top of foam crib. Refer to Figure 7.



Figure 7

2. Snap retaining strap to new assembly. Refer to Figure 6.

Service Information

INSTALLATION OF NEW CELL ASSEMBLY (CONT'D)

3. Fold back cell assembly to expose tubing.



Figure 8

4. Insert tubing into opening in foam crib.
Note: Maintain tubing orientation.
5. Fold back head end of mattress. Refer to Figure 3.
Note: Two people required to fold back foam crib and head box.



Figure 9

6. Connect tubing to new 900 fittings, two places. Rubbing alcohol may be applied to fittings for easier installation. Ensure fittings are fully inserted into tubing. Refer to Figure 10.
7. Return head end of mattress down to original flat position.
Note: Two people required to fold back foam crib and head box.

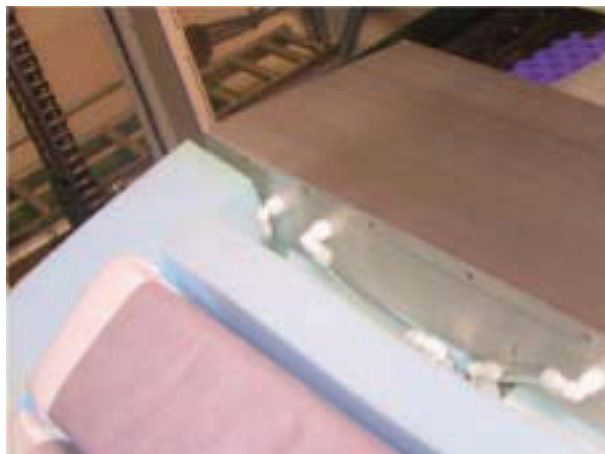

Figure 10

[Return To Table of Contents](#)

Service Information

INSTALLATION OF NEW CELL ASSEMBLY (CONT'D)

8. Twist spiral tubing clockwise onto new 900 fitting on head box. See Figure 11 and tubing routings for correct installation. Rubbing alcohol may be applied to fittings for easier installation.
9. Push 900 fitting from spiral tubing into tubing from air cell assembly. See Figure 11 and tubing routings for correct installation. Rubbing alcohol may be applied to fittings for easier installation. Ensure fittings are fully inserted into tubing.
10. Repeat steps 7 & 8 for three remaining spiral tubing connections.
11. Zip mattress cover closed.
12. Power up mattress.
13. After mattress fill, (approximately 1 minute) verify the mattress is flat. The rotation bladders should not fill.
14. Put the mattress into the service mode. (Lock Screen, Hold Percussion 5 seconds, Hold Rotation 5 seconds, Press Start).
15. Perform a diagnostic test to verify the mattress is working correctly.





Figure 11

Service Information

WARNING

The service screen and its functions are for use by authorized service personnel only otherwise equipment malfunction could result.

TO ACCESS THE SERVICE SCREEN

1. Plug the mattress power cord into a power source.
2. With the mattress and pendant functioning.
 - a) Select 
 - b) Select and hold  for approximately five seconds.
 - c) Select and hold  for approximately five seconds until the service welcome displays on the controller.

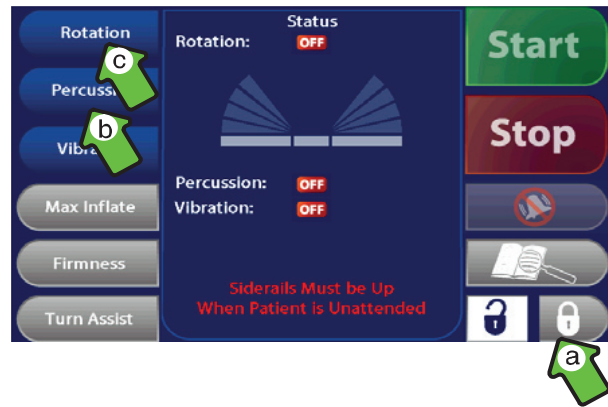

Note

- Lock/Rock/Roll

3. Select  to enter the service screen.



Service Information

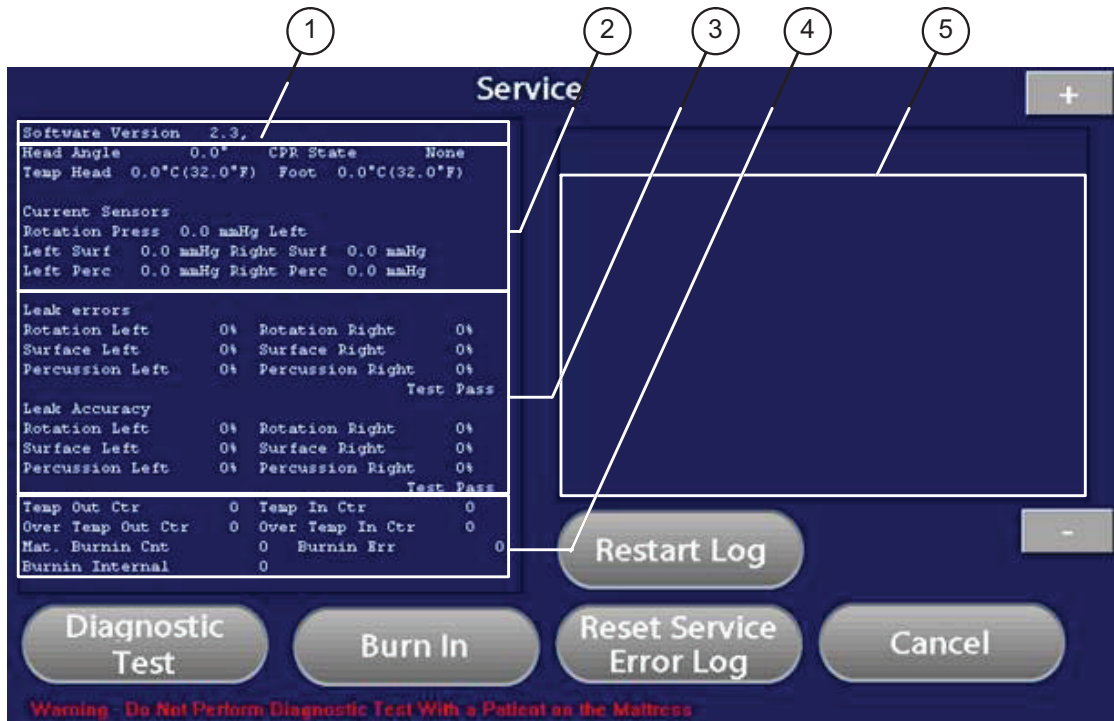

1. Pendant and CPU software revision.
2. Current status of the mattress. Automatically refreshes every few seconds.
3. Result of Diagnostic Test. Shows no values until the Diagnostic Test is run. Values update as tests are executed.
4. Overtemperature status.
5. Service/Error log. Displays service codes and descriptions. Press or to scroll through the list of events/errors.

Service Information

SERVICE SCREEN FUNCTIONS

To run the mattress diagnostic test select **Diagnostic Test**. The test runs automatically and takes a few minutes. The mattress bladders inflate and are tested for leaks.

WARNING

Do not perform the Diagnostic Test with a patient on the mattress to ensure patient safety.

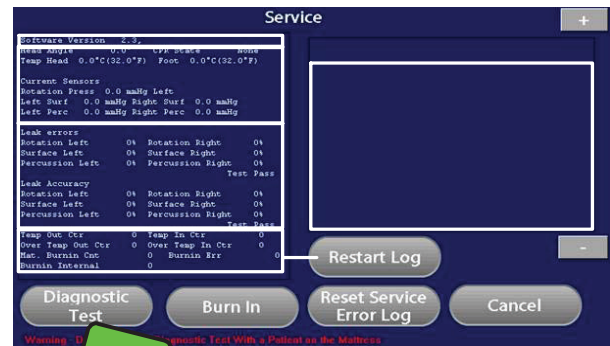

Burn-In is used in 'Manufacturing' to test the mattress prior to shipment. Runs functions automatically for 24 hours.

WARNING

Do not perform Burn-In with a patient on the mattress to ensure patient safety.

Note

This is not used in the field.

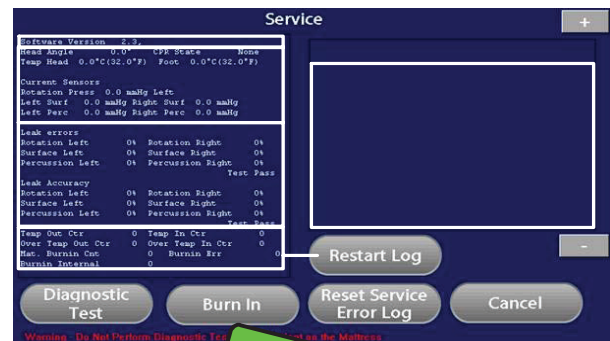

Press **Restart Log** to update event information from the CPU. Use when replacing a controller.

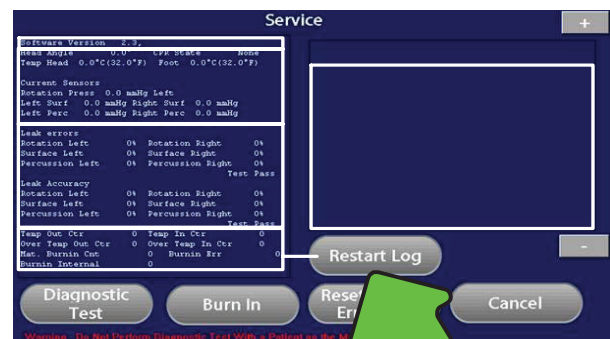



[Return To Table of Contents](#)

Service Information

SERVICE SCREEN FUNCTIONS (CONT'D)

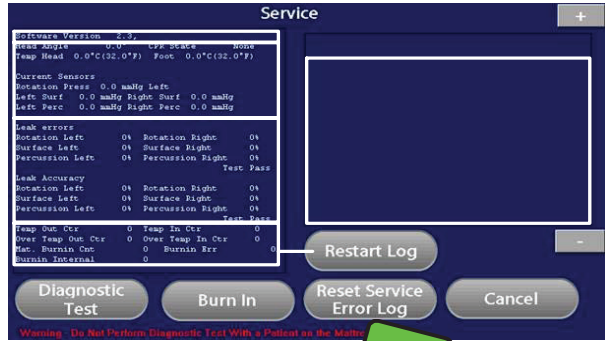
Press  to clear the service error log.



Press  to cancel any of the service screen functions.

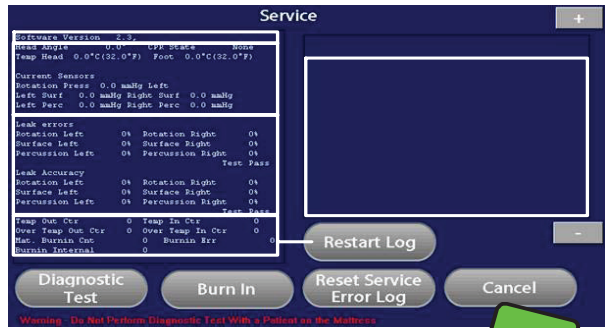

Service Information

SERVICE CODES

Note

- Primary wire color is reference first and the strip color is referenced second. For example, white/orange is a white wire with an orange stripe.
- Disconnect connector from the PC board during cable continuity tests. Never insert meter leads or anything else into the connector pin receptacle and check continuity at the access slot on the side of the connector.

Service Event	Code	Description	Problem Area
Pendant_Disconnected	65	<p>No heartbeat between the pendant and the head box control</p> <p>PCB communication. Headbox beeps during disconnect.</p> <p>Possible installation procedure was not followed and mattress was powered up without pendant connected.</p> <p>Suggest reset service log and monitor for additional error 65.</p> <p>Proceed to troubleshooting if multiple errors are logged.</p>	<ol style="list-style-type: none"> 1. Check black cable connector is secure and twist locked. 2. Check wire continuity of all black cable wires from foot box PCP to pendant PCB. 3. Check blue cable, white/orange, white/blue and blue/white wires for continuity from foot box to head box. 4. Check yellow cable and clear wire for continuity from foot box to head box.
CPR_Left	66	Left CPR plug is not detected.	<ol style="list-style-type: none"> 1. Check CPR plug on patient left side is fully engaged and snapped. 2. Check blue wires are connected to common and normally open contacts of CPR switch in head box. 3. Check for switch continuity between blue wires when plug is engaged. 4. Check connector is fully engaged to head box control PC board TB6.
CPR_Right	67	Right CPR plug is not detected.	<ol style="list-style-type: none"> 1. Check CPR plug on patient right side is fully engaged and snapped. 2. Check violet wires are connected to common and normally open contacts of switch. 3. Check for switch continuity between violet wires when plug is engaged 4. Check connector is fully engaged to PCB TB6.
CPR_Both	68	Both CPR plugs are not detected.	<ol style="list-style-type: none"> 1. Check CPR plugs are fully engaged and snapped. 2. Check connector is fully engaged to PCB TB6.

[Return To Table of Contents](#)

Service Information

SERVICE CODES

Service Event	Code	Description	Problem Area
FootEndLow	69	Abnormal temperature in foot box. Temperature is between 120 - 140 degrees F.	This message is entered into the service log as information only for trending purposes. There is no error message displayed to the user.
FootEndHigh	70	Over temperature in foot box. Temp. > 140 degrees F. Displays message "Auto. Overload Caused a Power Shutdown."	<ol style="list-style-type: none"> 1. Let unit cool, reset service alarm by resetting service log and cycling power. Open service screen and if temperature is over 140 with cool foot box, check blue cable, white/green and orange/white conductors. Bend blue cable at all connector locations and monitor foot box temperature reading. Check for continuity or intermittence in all blue wire harnesses between the foot box and head box for white/green and orange/white conductors. 2. Check for kinked supply tubing in mattress and replace with wire reinforced supply tubing and clamps if necessary. 3. Check for kinked Low Air Loss tubing. 4. Check for plugged bulkhead fitting at foot box and replace if necessary. 5. Check for kinked tubing from compressor to bulkhead fitting in foot box. 6. Check for supply tubing too close or touching sensor U5 on power PCB.
HeadEndLow	71	Abnormal temperature in head box. Temperature is between 120 - 140 degrees F.	This message is entered into the service Log as information only for trending purposes. There is no error message displayed to the user.
HeadEndHigh	72	Over temperature in head box. Temp. > 140 degrees F. Displays message "Auto. Overload Caused a Power Shutdown."	<ol style="list-style-type: none"> 1. Check for overheated percussion motor. 2. Check percussion motor belt tension. 3. Check connecting rod bearing.
TurnAssist	73	Turn-Assist time limit was reached.	Operator selected turn assist nursing feature and did not return to a therapy mode. Train operator on Turn-Assist function and alarms.
TurnAssist	73	Turn-Assist time limit was reached.	Operator selected turn assist nursing feature and did not return to a therapy mode. Train operator on Turn-Assist function and alarms.

Service Information

SERVICE CODES

Service Event	Code	Description	Problem Area
MaxInflate	74	Max inflate time limit was reached.	Operator selected Max Inflate nursing feature and did not return to a therapy mode. Train operator on Max Inflate function and alarms.
HugePressureLeak	75	Set point pressure was not reached within 10 minutes. Unit may not complete "Preparing Surface" screen. Displays message "Service Required by Qualified Service Personnel".	<ol style="list-style-type: none"> 1. Check for tubing leaks at connections. 2. Check for leaks in cells. 3. Check CPR engagement and "O" rings. 4. Check for compressor output of 28 to 32 lpm during initial inflation. This can be tested by connecting a flow meter in line at foot box, pulling a CPR plug and holding CPR limit switch engaged. 5. Check for kinked supply tubing in mattress and replace with wire reinforced supply tubing and clamps if necessary. 6. Check for plugged bulkhead fitting at foot box and replace if necessary.
LowPressureLeak	76	The compressor restarted 20 times with less than 20 seconds between each restart.	This message is entered into the service log as information only for trending purposes. There is no error message displayed to the user.
Stepper_Alarm	77	Stepper motor could not find home in specified number of steps.	<ol style="list-style-type: none"> 1. Check that the stepper motor/rotary valve completes two revolutions and stops with the flag in front of the optical sensor during power-up. 2. Check that the valve spins freely by hand and is not bound or jammed. 3. Check that the connectors are fully seated in the head box control PC board at TB9 and TB10. 4. Check the optical sensor for a voltage between the orange and green wires (TB9) for 1.2 volts. If not present, replace head box control PC board. 5. Check the optical sensor for a voltage between the blue and white wires (TB9) of less than 0.2 volts DC when the flag is aligned with the sensor and greater than 4.0 volts DC when not aligned. Replace sensor if necessary.

[Return To Table of Contents](#)

Service Information

SERVICE CODES

Service Event	Code	Description	Problem Area
PercMotor Speed Alarm	81	Percussion motor does not run.	<ol style="list-style-type: none"> 1. Check drive belt is not broken or worn. 2. Manually try to rotate percussion shaft. Check for binding or bearing wear. Check the shaft pulley for loose set screws. Repair or replace as necessary. 3. Check that the connectors are fully seated in the head box control PC board at TB2 and TB8. 4. Set percussion therapy and check that the motor tries to turn. Check or 24 volts DC at TB2 during initial therapy activation. If voltage present, replace motor. If voltage is not present, replace head box control PC board. 5. Check the optical sensor for a voltage between the orange and green wires (TB8) for 1.2 volts. If not present, replace head box control PC board. 6. If motor spins momentarily but then stops, check the optical sensor for a voltage between the blue and white wires (TB8) of less than 0.2 volts DC when the shaft is blocking the sensor and greater than 4.0 volts DC when the flat is aligned. Align or replace sensor if necessary.
HeadEndElevation	85	Head elevation is 60 degrees or greater.	<ol style="list-style-type: none"> 1. Operator selected rotation therapy with the head of the bed at greater than 60 degree angle. Train operator on rotation therapy function and alarms.
MainPressureLeak	91	Percussion cells did not inflate to pressure set point within 10 seconds.	<ol style="list-style-type: none"> 1. Check for leaks in percussion cells. 2. Check for compressor output of 28 to 32 lpm during initial inflation. This can be tested by connecting a flow meter in line at foot box, pulling a CPR plug and holding CPR limit switch engaged. 3. Check for kinked supply tubing in mattress and replace with wire reinforced supply tubing and clamps if necessary. 4. Check for plugged bulkhead fitting at foot box and replace if necessary.

Service Information

SERVICE CODES

Service Event	Code	Description	Problem Area
ProductionTestLeak	92	Cell under diagnostic test did not inflate to 50 mmHg pressure within 3 minutes. This message will only occur during a diagnostic test from the service screen.	<ol style="list-style-type: none"> 1. Check for tubing leaks at connections. 2. Check for leaks in cells. 3. Check CPR engagement and "O" rings. 4. Check for compressor output of 28 to 32 lpm during initial inflation. This can be tested by connecting a flow meter in line at foot box, pulling a CPR plug and holding CPR limit switch engaged. 5. Check for kinked supply tubing in mattress and replace with wire reinforced supply tubing and clamps if necessary. 6. Check for plugged bulkhead fitting at foot box and replace if necessary.
StepperOverCurrent	95	An over-current has been detected on the stepper motor drive circuit.	<ol style="list-style-type: none"> 1. Check for cut or shorted wires between the control PC board at TB10 and the stepper motor. 2. Replace rotary valve assembly.
ValvesOverCurrent	96	An over-current has been detected in one of the solenoid valves.	<ol style="list-style-type: none"> 1. Check for cut or shorted wires between the control PC board at TB12 or TB14 and one of the solenoid valves. 2. Replace solenoid valve.
PercOverCurrentAlarm	97	An over-current has been detected on the percussion motor.	<ol style="list-style-type: none"> 1. Check for cut or shorted wires between the control PC board at TB2 and the percussion motor. 2. Replace percussion motor.
FootOverTempService	98	Two or more FootEndHigh alarm code 70 occurred within 24 hours.	<ol style="list-style-type: none"> 1. Refer to alarm code 70 for troubleshooting steps. 2. The service log must be reset to clear this alarm.
HeadOverTempService	99	Two or more HeadEndHigh alarm code 70 occurred within 24 hours.	<ol style="list-style-type: none"> 1. Refer to alarm code 72 for troubleshooting steps. 2. The service log must be reset to clear this alarm.
OverPressureReading	100	Excessive pressure was sensed in an air cell that is not intended to be filling.	<ol style="list-style-type: none"> 1. Rotary valve stopped at the wrong position and is filling the wrong cell. 2. Check tubing for proper connections.

[Return To Table of Contents](#)

Service Information

SERVICE CODES

Service Event	Code	Description	Problem Area
12VPowerFailure	101	12 volt supply drops below 10 volts.	<ol style="list-style-type: none"> 1. Check for 24 to 30 volts DC nonfiltered at the power PC board between J4 pin 3 and J4 pin 4 and also at control PC board between TB1 pin 2 and TB1 pin 3. 2. Check for 12 VDC between TP9 and TB1 pin 2. 3. Replace control PC board.
CorruptedMemory	103	Controller has detected corrupted memory.	<ol style="list-style-type: none"> 1. Replace control PC board.
Sensor Select Solenoid Valve	104-0	The compressor is on 100% for an extended time while filling a rotation cell.	<ol style="list-style-type: none"> 1. Check sensor select solenoid valve, item 24 in the head box. If this valve is not working, a rotation cell may be filling but the pressure transducer is monitoring the wrong cell. During the diagnostic test, the left rotation cell (patient perspective) will fill first and the pressure can be monitored on the display. If the left cell is inflating but the pressure display does not change, the valve is stuck in the energized state. Continue to monitor during the right cell inflation, if the display does not change, the valve is stuck in the de-energized state. 2. Check for compressor output of 28 to 32 lpm during initial inflation. This can be tested by connecting a flow meter in line at foot box, pulling a CPR plug and holding CPR limit switch engaged. 3. Check for kinked supply tubing in mattress and replace with wire reinforced supply tubing and clamps if necessary. 4. Check for plugged bulkhead fitting at foot box and replace if necessary. 5. Check main valve marked "M". If the main valve is sticking, the air flow will be routed to the low air loss tubing instead of the cell assemblies. 6. Check CPR engagement and "O" rings.

Service Information

SERVICE CODES

Service Event	Code	Description	Problem Area
Sensor Select Solenoid Valve	104-1	The system did not detect a difference in pressure between the two rotation circuits. Both rotation cells are filling at the same time.	<ol style="list-style-type: none">1. Check CPR engagement and "O" rings.2. Check for leakage path between the rotation cells.3. This alarm is more susceptible when the rotation rate is set very low, there is patient movement or no patient on the mattress.

Service Information

ALARMS / ERRORS

If the screen displays “ALARM Service Required by Qualified Service Personnel”, something has occurred to prevent the mattress from providing therapy. Service is required by qualified service personnel.

- If the message displays when the mattress is powering up, remove the mattress from use and notify service.
- If the message displays when a therapy is selected, service will be required before the selected therapy can be used.

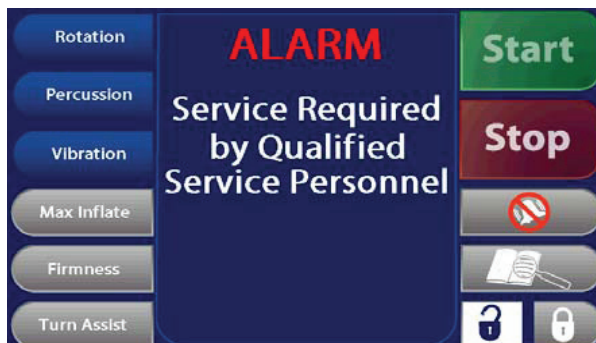

If the screen displays “ALARM Auto. Overload Caused a Power Shut Down Ref. Oper. Manual”, the mattress will automatically shutdown. Immediately unplug the mattress power cord from the power source and remove the patient from the mattress.

- After 30 minutes have elapsed, if the condition has cleared and the unit is plugged into the power source, the mattress will restart. If the overload condition occurs again within 24 hours, the mattress cannot be used until service is performed by qualified service personnel.

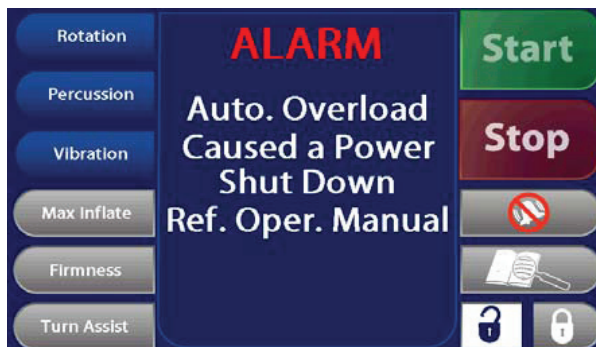

ERRORS

Service Event	Code	Description
CHANGE_STEPPER_MOTOR	6	Failed first attempt to position the stepper motor. This error is not applicable at SW version 2.5.4.
MAIN_LEAK	136	Diagnostic test leak rotation bladder circuit.
LEFT_SURFACE_LEAK	137	Diagnostic test leak rotation bladder circuit.
RIGHT_SURFACE_LEAK	138	Diagnostic test leak rotation bladder circuit.
LEFT_PERCUSSION_LEAK	139	Diagnostic test leak rotation bladder circuit.
RIGHT_PERCUSSION_LEAK	140	Diagnostic test leak rotation bladder circuit.
INVALID_COMMAND	146	An invalid command has been received by the mattress controller.
	30	Stepper motor did not reach home during initial rotation.

Pneumatic Diagram

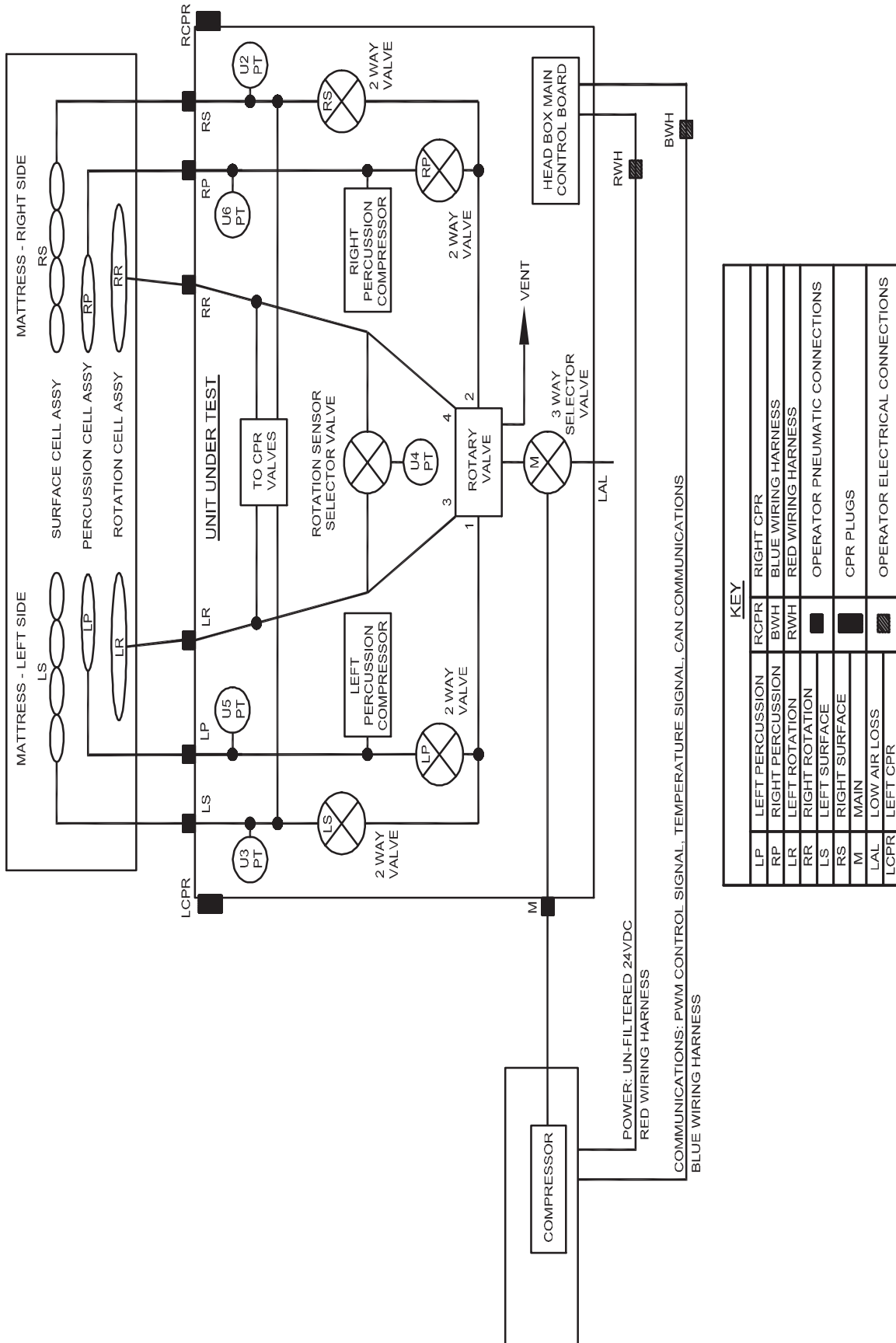

KEY	
LP	LEFT PERCUSSION
RP	RIGHT PERCUSSION
LR	LEFT ROTATION
RR	RIGHT ROTATION
LS	LEFT SURFACE
RS	RIGHT SURFACE
M	MAIN
LAL	LOW AIR LOSS
LCPR	LEFT CPR
RCPR	RIGHT CPR
BWH	BLUE WIRING HARNESS
RWH	RED WIRING HARNESS
■	OPERATOR PNEUMATIC CONNECTIONS
■	CPR PLUGS
▨	OPERATOR ELECTRICAL CONNECTIONS

[Return To Table of Contents](#)

Foot Box Wiring Block Diagram

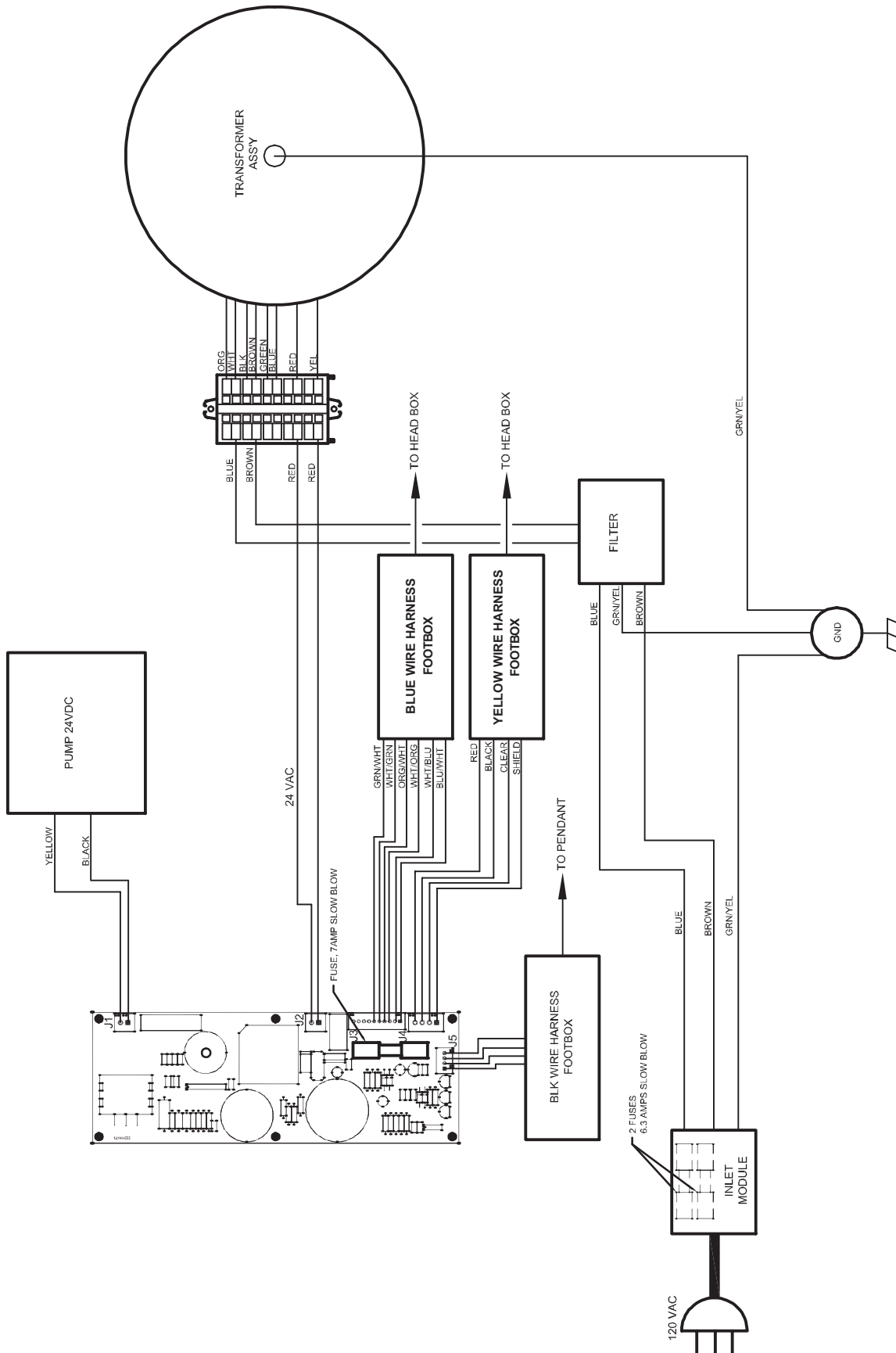

Head Box Wiring Block Diagram

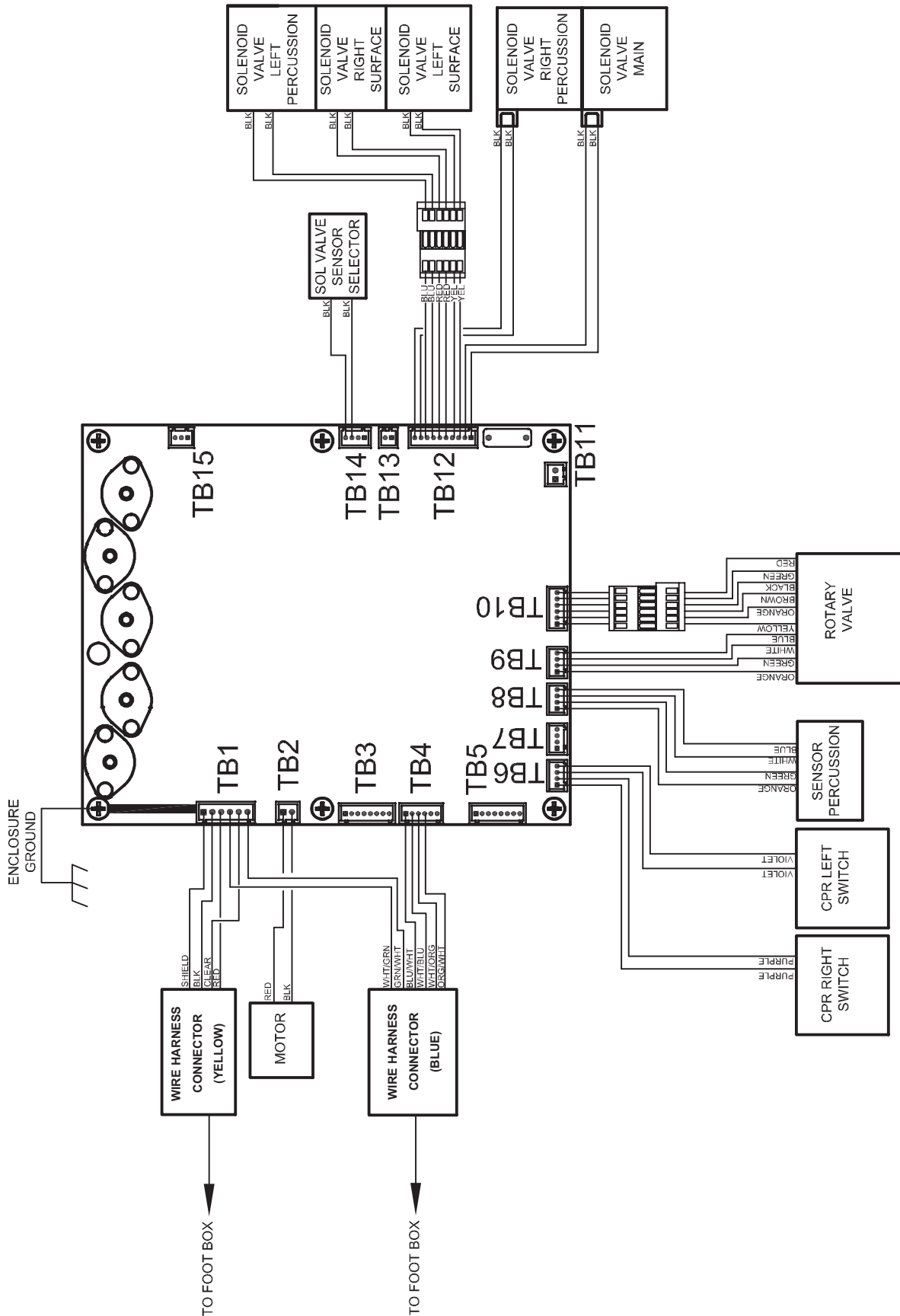

[Return To Table of Contents](#)

Mattress Assembly - 2950-000-000/2950-000-001

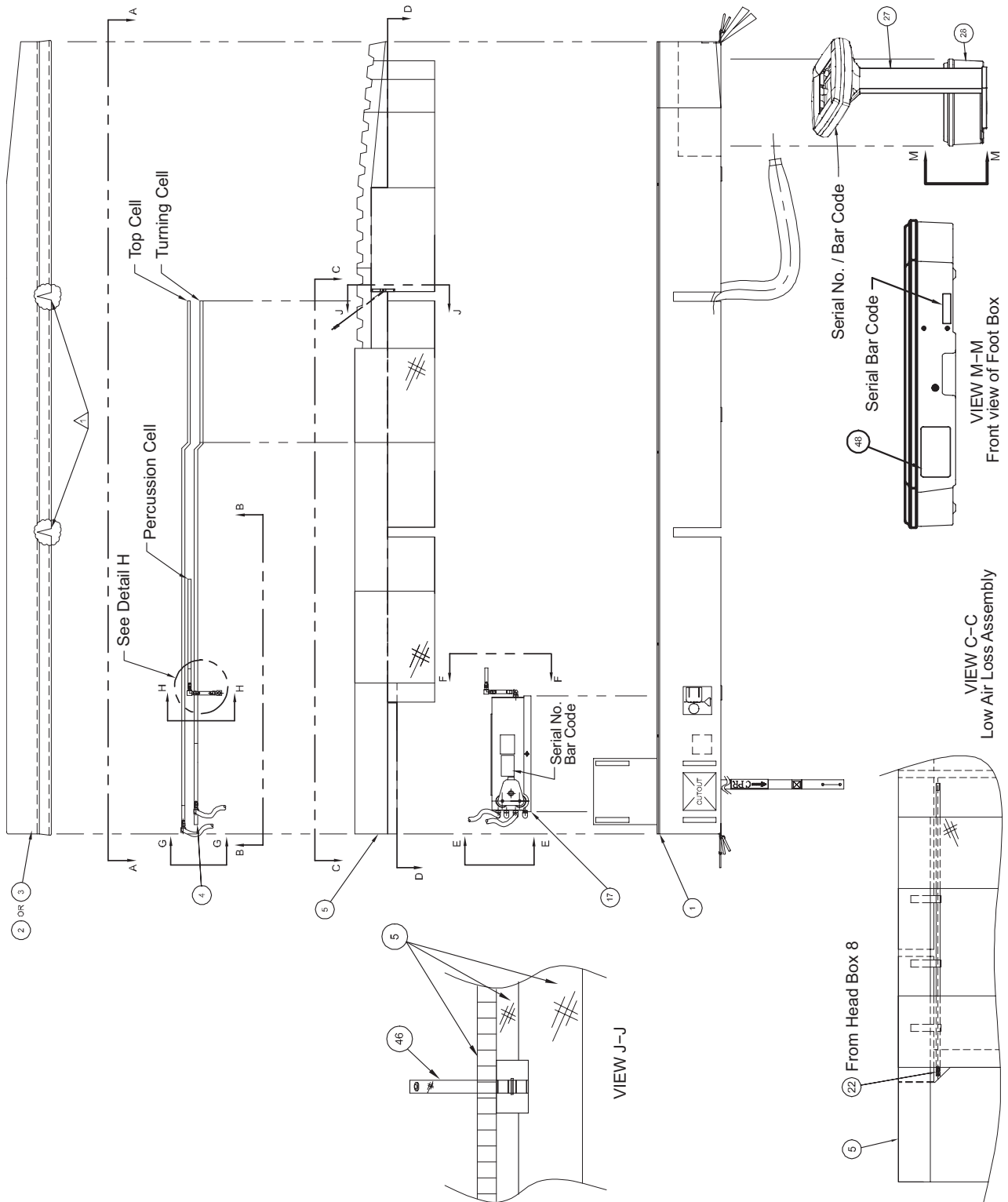

Mattress Assembly - 2950-000-000/2950-000-001

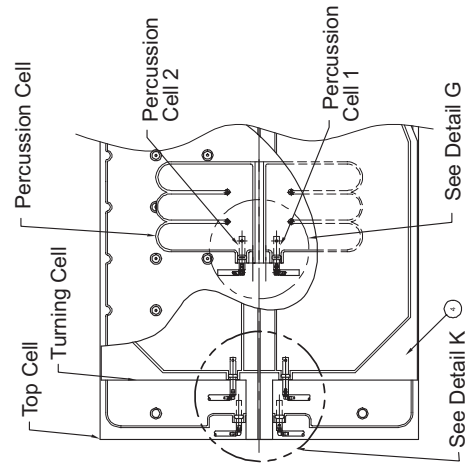
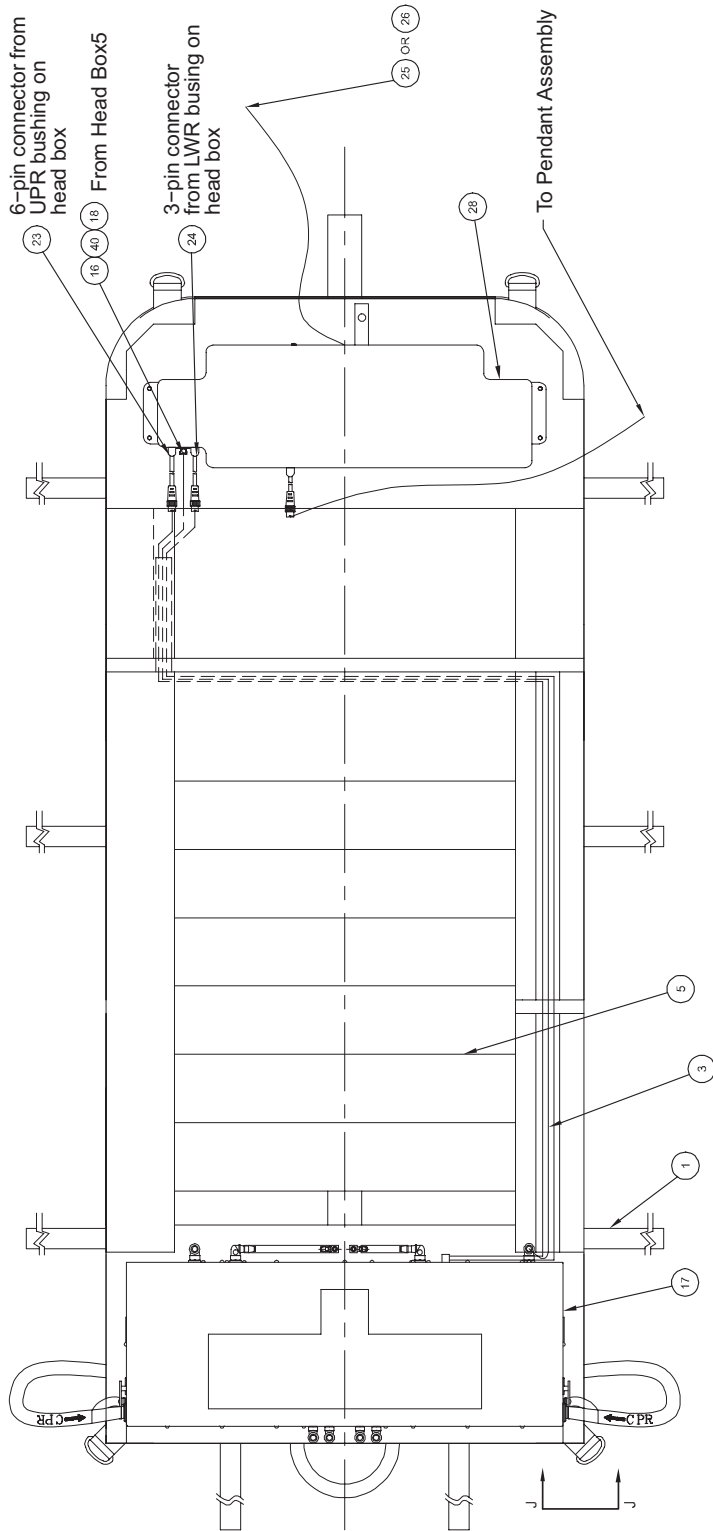

VIEW B-B

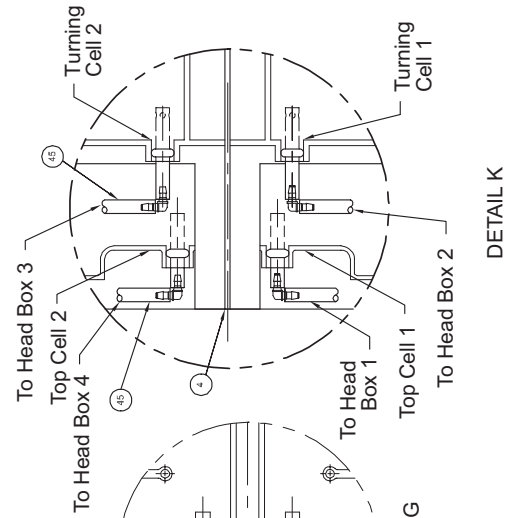

DETAIL K

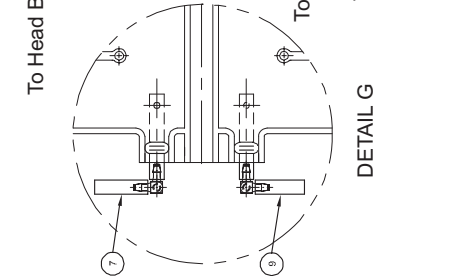

DETAIL G

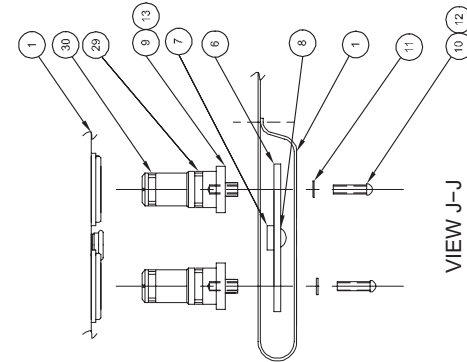

VIEW J-J

[Return To Table of Contents](#)

Mattress Assembly - 2950-000-000/2950-000-001

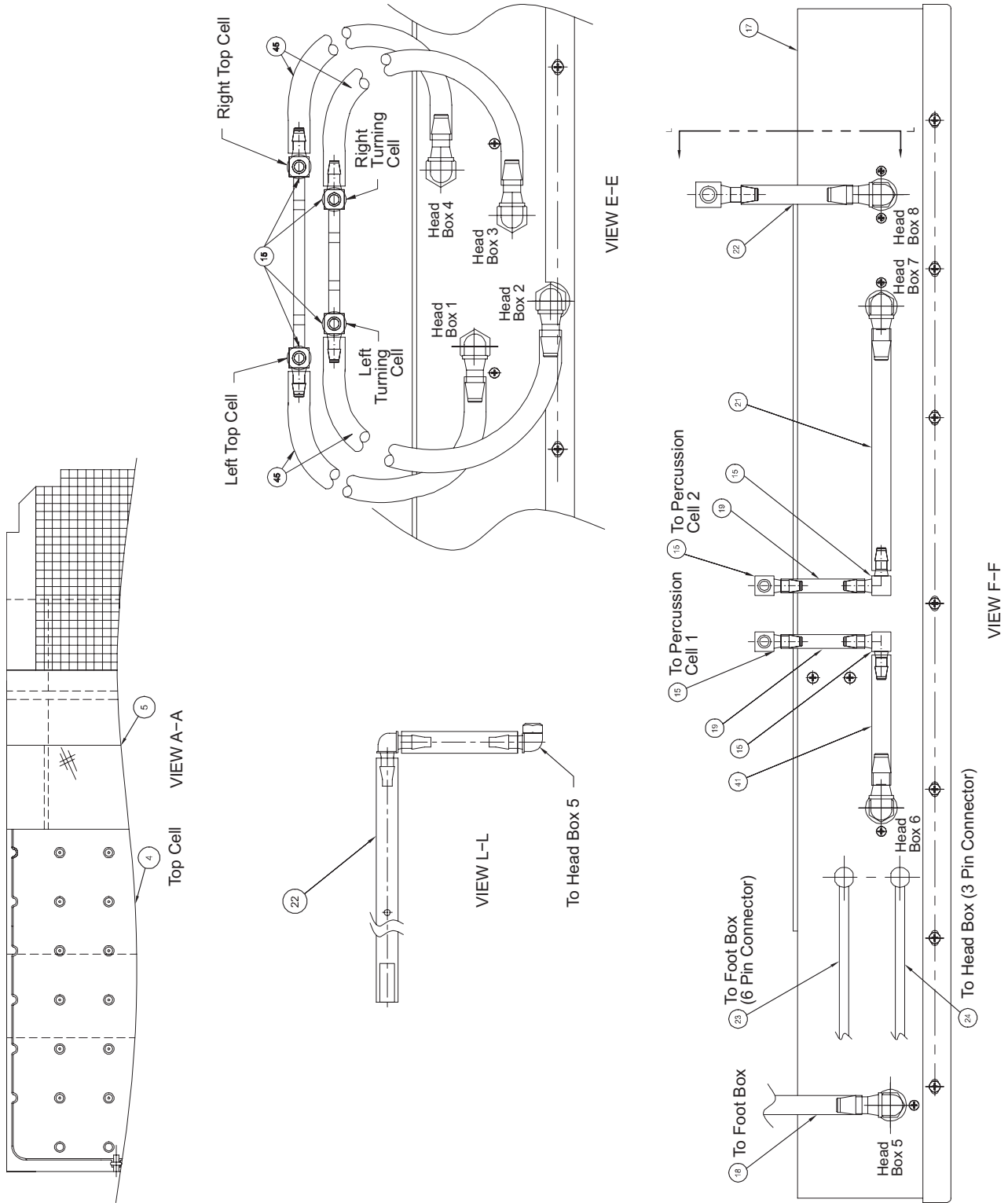

Mattress Assembly - 2950-000-000/2950-000-001

Item	Part No.	Part Name	Qty.
1	2950-001-401	Bottom Cover	1
2	2950-001-402	Top Cover, Dartex	1
3	2950-001-403	Top Cover, Nylon	1
4	2950-001-404	Cell Assembly	1
5	2950-001-405	Crib Assembly	1
6	2950-001-406	Keeper, CPR Dump	2
7	2950-001-407	Snap Stud 9/16	2
8	2950-001-408	Snap Eyelet 9/16	2
9	2950-001-409	Pin, CPR Dump	4
10	2950-001-410	Screw, 8-32UNC	4
11	2950-001-411	Flat Washer, #8	4
14	2950-001-414	Tubing, Vinyl 1/2 ID x 6 1/2 Lg	1
15	2950-001-415	Fitting, 90 Deg Elbow, 1/2 B Single	8
16	2950-001-416	Coupling, Male	1
17	(page 87)		
	2950-001-417)	Head Box Assembly	1
18	2950-001-418	Tubing, Vinyl 3/8 ID x 9/16 OD x 91.5 Lg	1
19	2950-001-419	Tubing, Vinyl 1/2 ID x 2 1/4 Lg	2
21	2950-001-421	Tubing, Vinyl 1/2 ID x 6.5 Lg	1
22	2950-001-422	Hose Assembly, LAL	1
23	2950-002-801	Wire Harness, Ft. to Hd. Box, Blue	0
24	2950-002-803	Wire Harness, Ft. to Hd. Box, Yellow	0
25	2950-001-425	Cord, Power 15 Ft Lg	1
26	2950-001-426	Cord, Power 3 Ft Lg	1
27	(page 86)		
	(2950-047-000)	Controller Assembly	1
28	(page 80)		
	(2950-001-428)	Foot Box Assembly	1
29	2950-001-429	O-Ring	4
30	2950-001-430	O-Ring	4
31	2950-001-431	Carton, Bottom	1
32	2950-001-432	Carton, Top	1
33	2950-001-433	Box, Insert	1
34	2950-001-434	Box, Insert Foot	1
35	2950-001-435	Spacer, Foot Box	1
36	2950-001-436	Spacer, Pendant	1
40	2950-001-440	Ty-Wrap (Clamp)	2
41	2950-001-441	Tubing, Vinyl 1/2 ID x 4 1/2 Lg	1
43	2950-009-001	Edge Protector, 4" Long	8
44	2950-009-001	Operations/Maintenance Manual	1
45	2950-001-445	Tubing, PVC, Reinforced	4
46	2950-001-446	Strap, Cell, Retaining	1
47	2950-001-178	Instruction Label	1

Foot Box Assembly - 2950-001-428

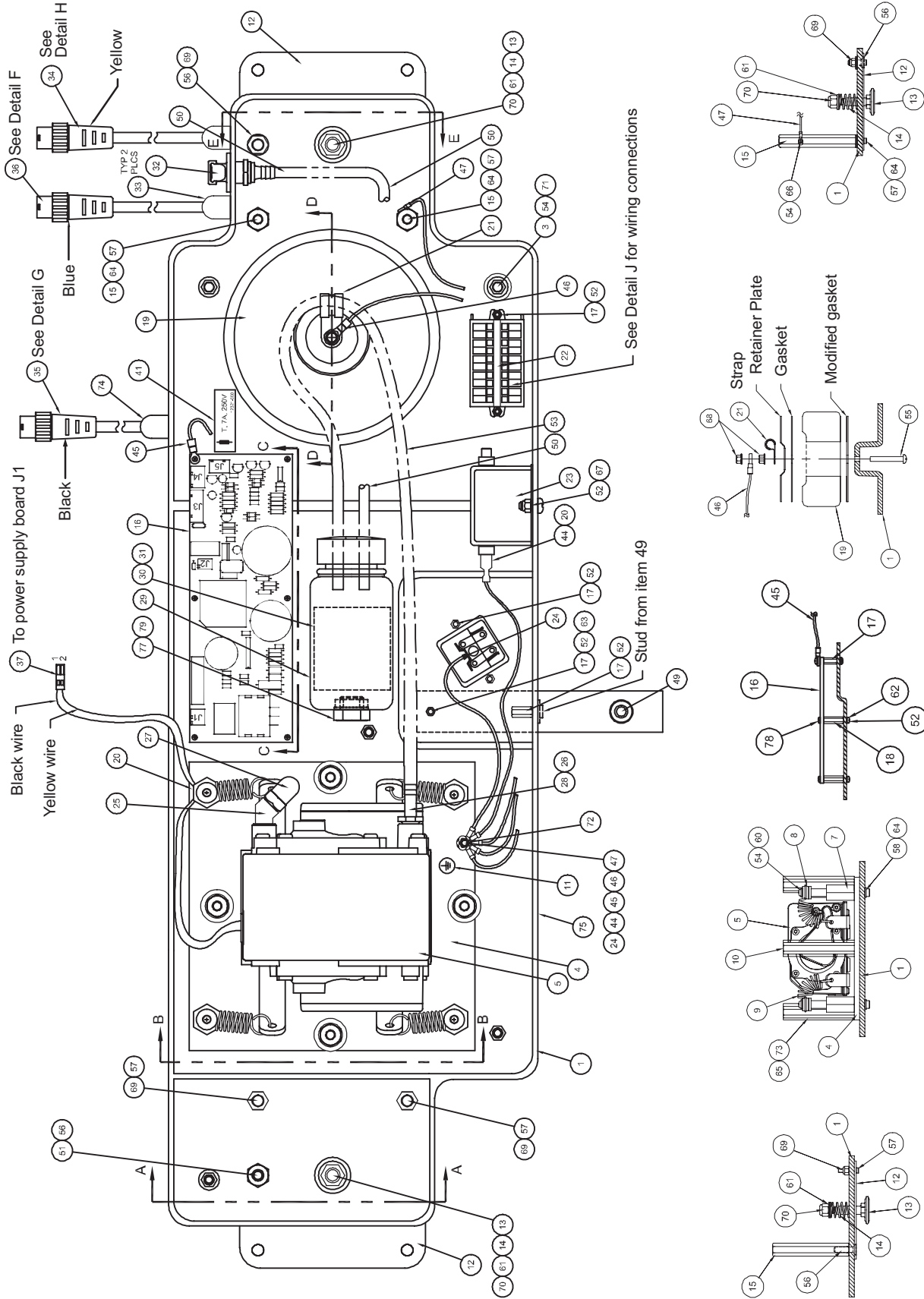

[Return To Table of Contents](#)

Foot Box Assembly - 2950-001-428

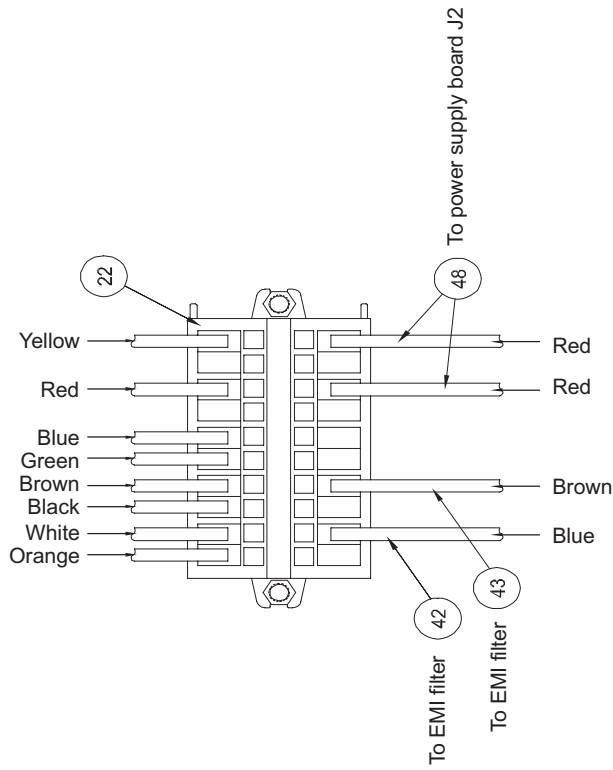

DETAIL J
Wires from transformer (item 19)

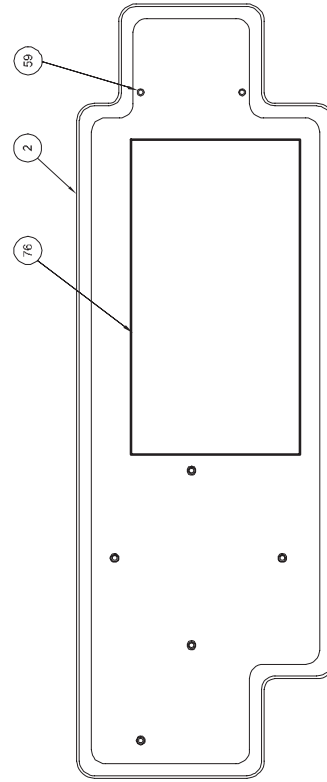

COVER TOP VIEW

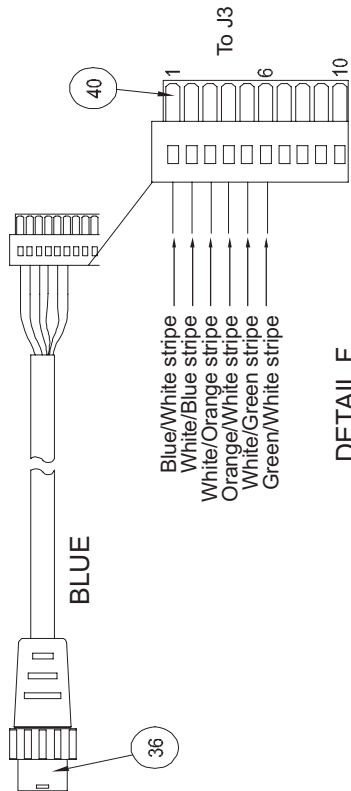

DETAIL F

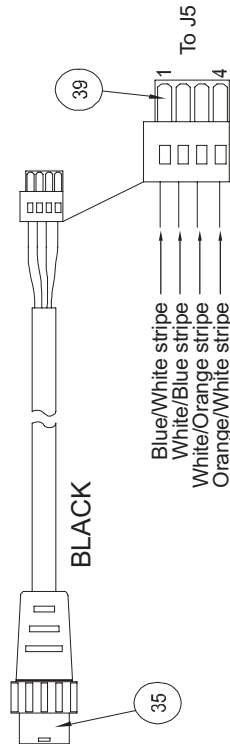

DETAIL G

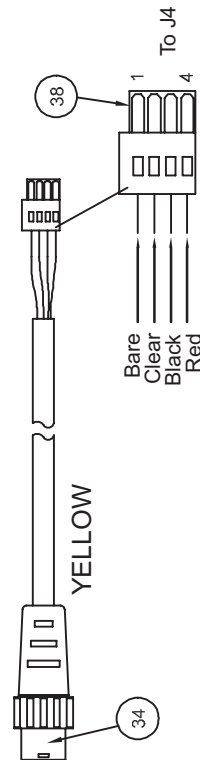

DETAIL H

Foot Box Assembly - 2950-001-428

Item	Part No.	Part Name	Qty.
1	2950-001-101	Foot Box, Bottom, Molded	1
2	2950-001-102	Foot Box, Top, Molded	1
3	2950-001-103	Foot, Polyastamer Gray	6
4	2950-001-104	Mounting Plate	1
5	2950-001-105	Pump, 24VDC	1
6	2950-001-106	Bumper, Vinyl	0
7	2950-001-107	Standoff 3/4 Hex	4
8	2950-001-108	Grommet, 5/8 OD x 5/16 ID	4
9	2950-001-109	Spring, Helical Extension	4
10	2950-001-110	Tubing, Vinyl 5/8 ID x 13/16 OD x 3 1/4 Lg	4
11	2950-001-111	Label Ground Identification	1
12	2950-001-112	Plate, Pendant Mount	2
13	2950-001-113	Pin, Retaining	2
14	2950-001-114	Spring, Die, Medium Duty 3/4"	2
15	2950-001-115	Standoff, 3/4 HEX x 3.79 Lg	2
16	2950-001-116	Power Supply Board Assembly	1
17	2950-001-117	Standoff, Hex Threaded 4-40 UNC x 1/2 Lg	8
18	2950-001-118	Standoff, Hex Threaded 4-40 UNC x 3/4 Lg	4
19	2950-001-119	Transformer Assembly	1
20	2950-001-120	Tie Wrap Self Locking 8"	A/R
21	2950-001-121	Strap, Rubber Cushion	1
22	2950-001-122	Block Terminal Front Entry	1
23	2950-001-123	Filter, EMI Power Line	1
24	2950-001-124	Inlet Power Harness	1
25	2950-001-125	Elbow 45° Brass 1/8 Male 1/8 Female NPT	1
27	2950-001-127	Fitting 90° Elbow 1/8-27 NPT To 3/8 Id Barb	1
28	2950-001-128	Fitting, Straight Brass 1/8 NPT 3/8 Tube	1
29	2950-001-129	Bottle, Square Altered	1
30	2950-001-130	Fstr, Loop, 2 Wx1 3/4lg W/Adhes Back/ Btl.	1
31	2950-001-131	Fstr, Hook, 2"w X 1 3/4" Lg W/Adhes Back	1
32	2950-001-132	Coupling, Bulkhead, Panel Mount	1
33	2950-001-133	Bushing Strain Relief, 90°	2
34	2950-002-804	Wire Harness, Foot Box, 17 Lg, Yellow	1
35	2950-001-135	Wire Harness, Footbox, 14 Lg, Black	1
36	2950-001-136	Wire Harness, Footbox, 17 Lg, Blue	1
37	2950-001-137	Block Terminal Conn, Female 2 Pin	1
38	2950-001-138	Block Terminal Conn, Female 4 Pin	1
39	2950-001-139	Block Terminal Conn, Female 4 Pin	1
40	2950-001-140	Block Terminal Conn, Female 10 Pin	1
41	2950-001-141	Label, Fuse Ratings XPRT	1
42	2950-001-142	Wire Harness Assembly	1
43	2950-001-143	Wire Harness Assembly	1
44	2950-001-144	Wire Harness Assembly, EMI Ground	1

Foot Box Assembly - 2950-001-428

Item	Part No.	Part Name	Qty.
45	2950-001-145	Wire Harness Assembly, PC Board Ground	1
46	2950-001-146	Wire Harness Assembly, Transformer Ground	1
47	2950-001-147	Wire Harness Assembly, Standoff Ground	1
48	2950-001-148	Wire Harness Assembly, Transformer Jumper	1
49	2950-001-149	Strap, W/ Button Socket	1
50	2950-001-150	Tubing, 1/4 ID x 18 Lg	1
51	2950-001-151	Standoff, 1/2 Hex x 3.67 Lg	1
52	2950-001-152	Screw, Mach Pan CR 4-40 UNC 2A x 1/2 Lg SST	14
53	2950-001-153	Tubing, Silicone 1/4 ID x 27 Lg	1
54	2950-001-154	Screw, Mach Ph Cr 8-32 UNC 2A x 1/2 Lg SST	11
55	2950-001-155	Screw, Mach PH CR 1/4-20 UNC 2A x 1 1/2 Lg SST	1
56	2950-001-156	Screw, Mach 82° FH CR 1/4-20 UNC-2A x 3/4 Lg	2
57	2950-001-157	Screw, Cap Socket Hd 1/4-20 UNC 3A x 3/4 Lg SST	4
58	2950-001-158	Screw, Cap Socket Hd 1/4-20 UNC 3A x 1 Lg SST	4
59	2950-001-159	Screw, Mach 82° FH CR 8-32 UNC 2A x 1/2 Lg	7
60	2950-001-411	Washer Plain NO. 8 SST	4
61	2950-001-161	Washer, Plain 5/16 SST	2
62	2950-001-162	Lockwasher, Spring No. 4 SST	6
63	2950-001-163	Washer, Finishing No. 4	1
64	2950-001-164	Lockwasher Spring, 1/4 SST	6
65	2950-001-165	Standoff 3.67 LG 4	
66	2950-001-166	Lockwasher External Tooth No. 8 SST	1
67	2950-001-167	Locknut, Elastic 4-40 UNC SST	2
68	2950-001-168	Nut with Lockwasher 1/4-20 UNC 2B SST	2
69	2950-001-169	Locknut, Elastic 1/4-20 UNC SST	3
70	2950-001-170	Locknut, Elastic 5/16-18 UNC SST	2
71	2950-001-171	Locknut, Elastic, 8-32 UNC SST	6
72	2950-001-172	Nut with Lockwasher 8-32 KEPS	2
74	2950-001-174	Bushing Strain Relief	1
75	Not Used		0
76	2950-001-176	Instruction Label	1
78	2950-001-178	Screw, Mach Ph Cr 4-40 UNC 2A x 1/4 LG SST	6

Pendant Assembly - 2950-047-000

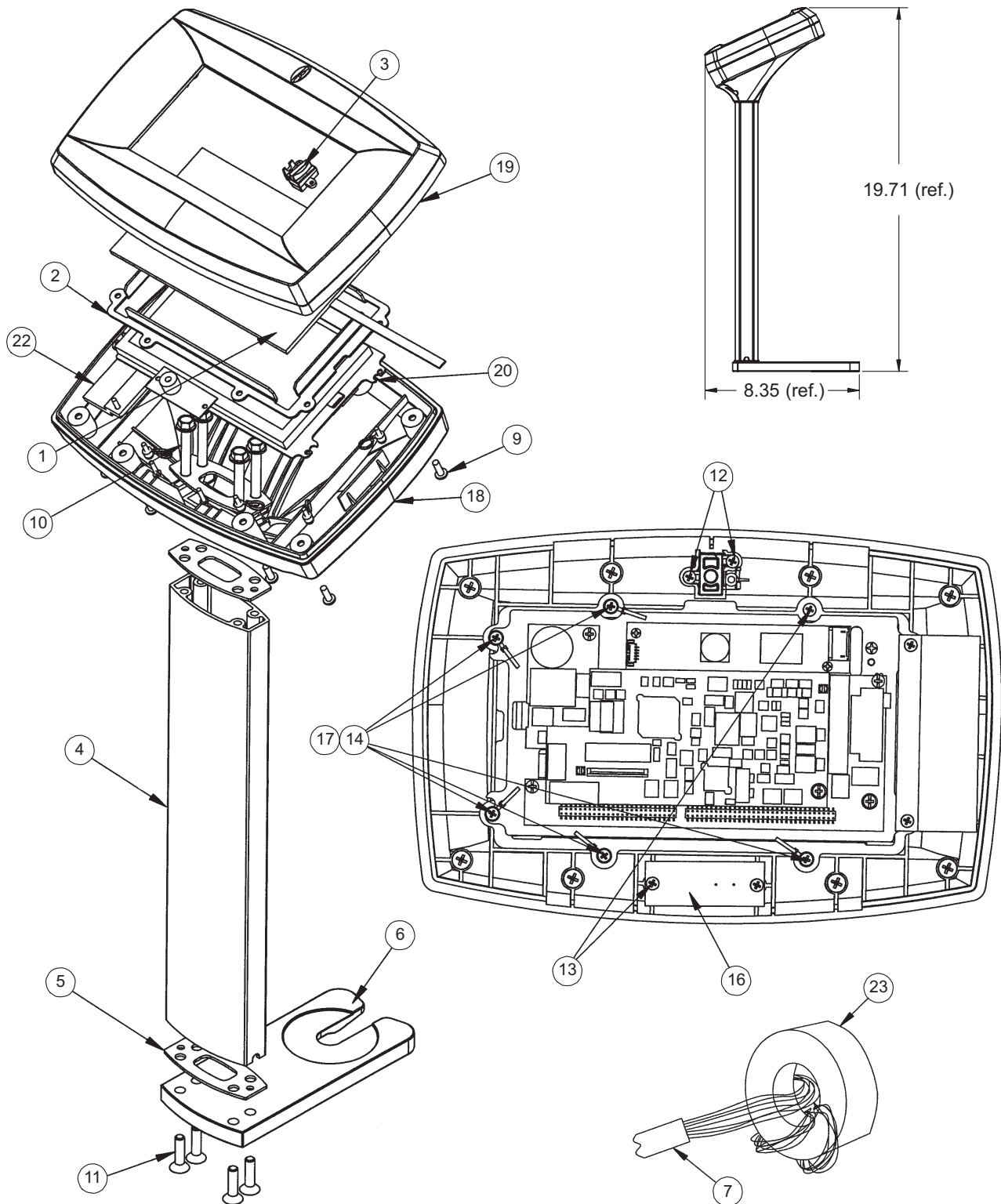

Pendant Assembly - 2950-047-000

Item	Part No.	Part Name	Qty.
1	2950-047-001	Touch Screen	1
2	2950-001-009	Screen Clamp	1
3	2950-001-003	LED Lens	1
4	2950-001-007	Column	1
5	2950-001-008	Mount Plate	3
6	2950-001-005	Base Mount	1
7	2950-001-804	Main Cable	1
8	2950-001-805	Inner Cable (not shown)	1
9	2950-047-006	Pan Head Screw	8
10	2950-047-007	Hex Head Flange	4
11	2950-047-008	Soc. Head Cap Screw	4
12	0050-050-000	Screw	2
13	0050-063-000	Screw	10
14	0011-199-000	Shim Washer	5
15	0036-640-000	Generic Label (not shown)	2
16	2950-001-800	Buzzer Board	1
17	2950-047-009	Tie Clamp	5
18	2950-001-002	Bottom	1
19	2950-001-001	Top	1
20	5400-050-060	Display Assembly	1
21	0072-002-061	GE RTV 108 Sealant (not shown) –	
22	2950-047-020	Bracket	1
23	2950-060-801	Ferrite	1

Head Box Assembly - 2950-001-417

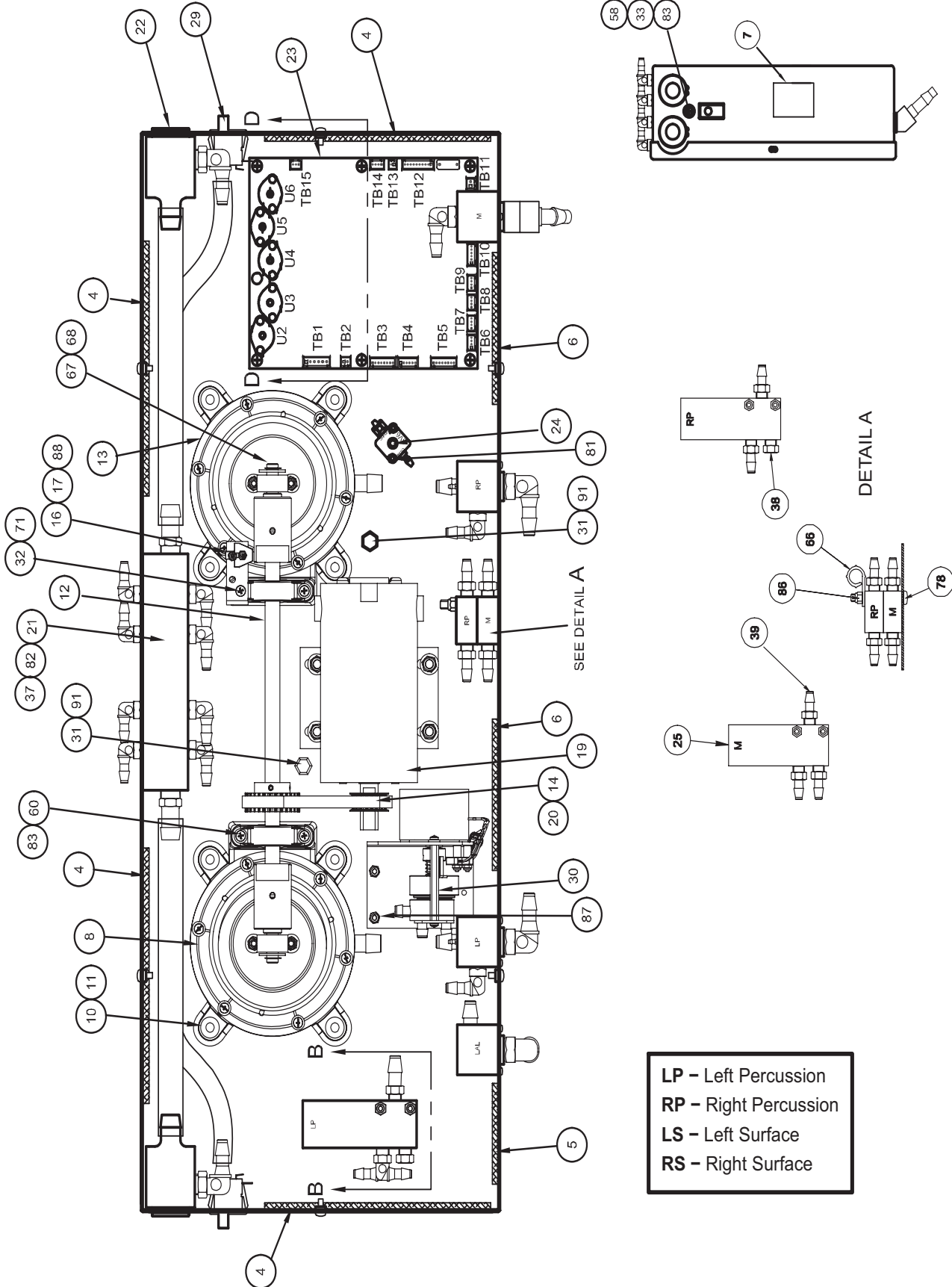

[Return To Table of Contents](#)

Head Box Assembly - 2950-001-417

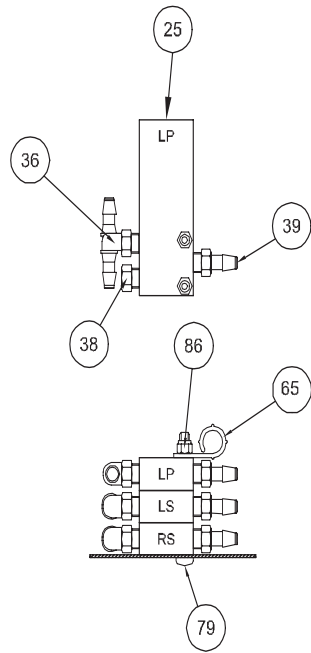

SECTION B-B

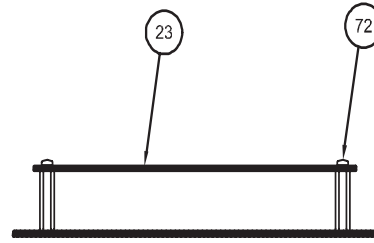

SECTION D-D

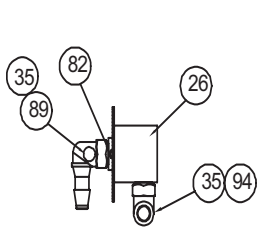
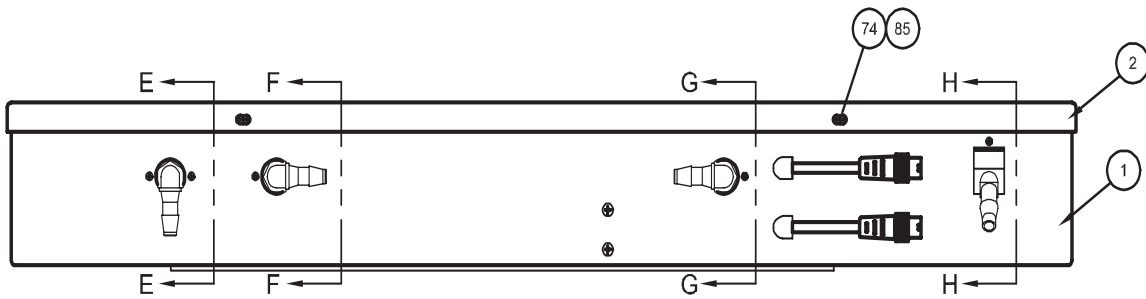

SECTION E-E

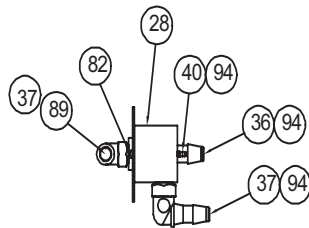

SECTION F-F

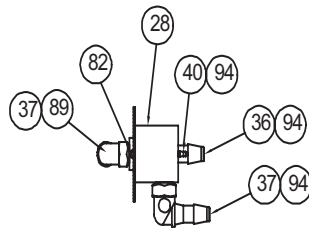

SECTION G-G

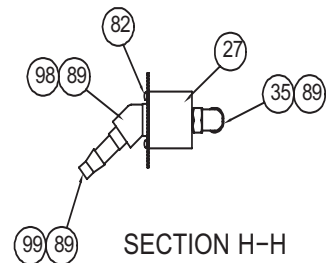

SECTION H-H

LP - Left Percussion
RP - Right Percussion
LS - Left Surface
RS - Right Surface

Head Box Assembly - 2950-001-417

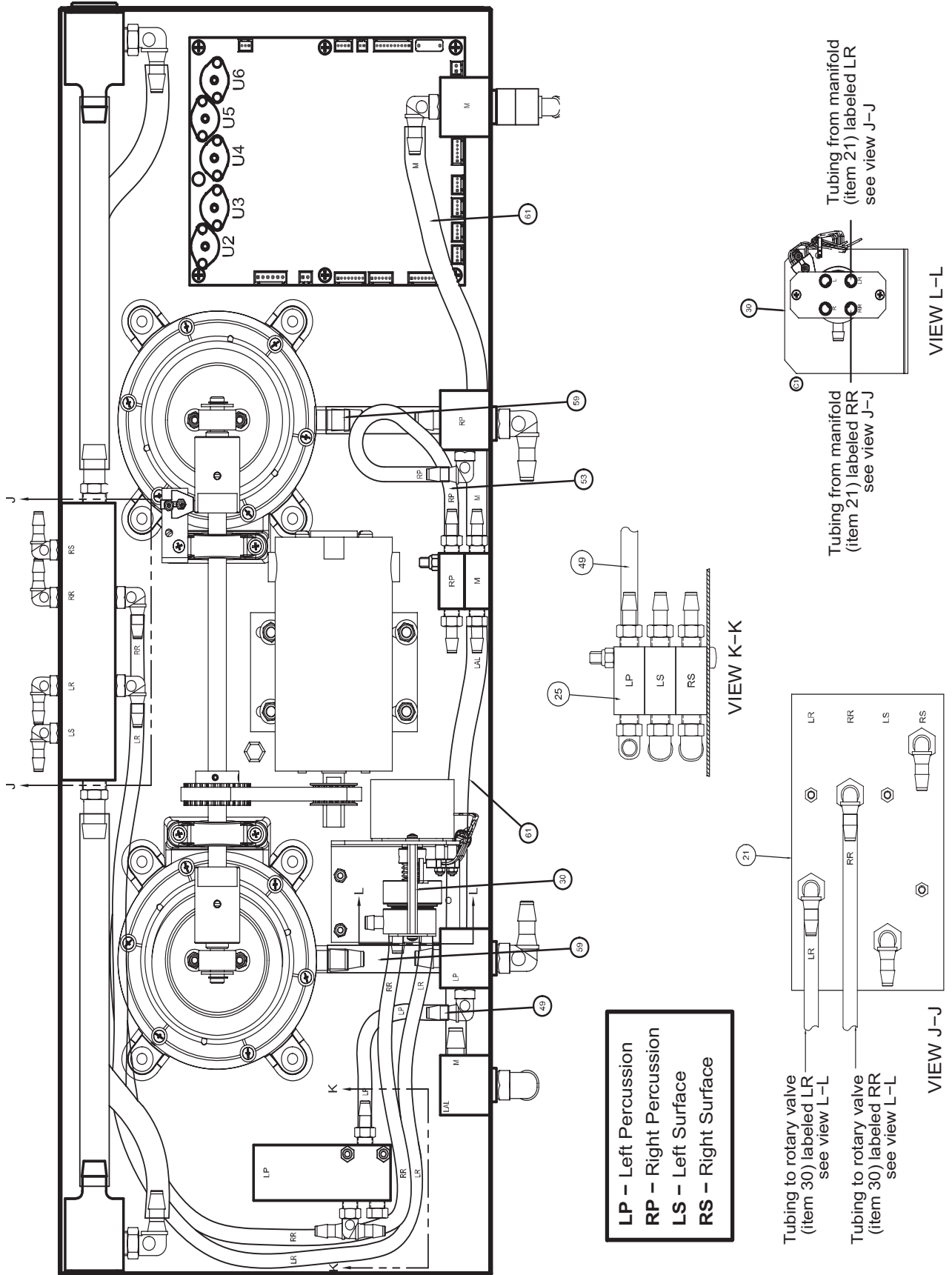

LP - Left Percussion
RP - Right Percussion
LS - Left Surface
RS - Right Surface

Tubing to rotary valve
 (item 30) labeled LR
 see view L-L

Tubing to rotary valve
 (item 30) labeled RR
 see view L-L

Tubing from manifold
 (item 21) labeled RR
 see view J-J

Tubing from manifold
 (item 21) labeled LR
 see view J-J

Head Box Assembly - 2950-001-417

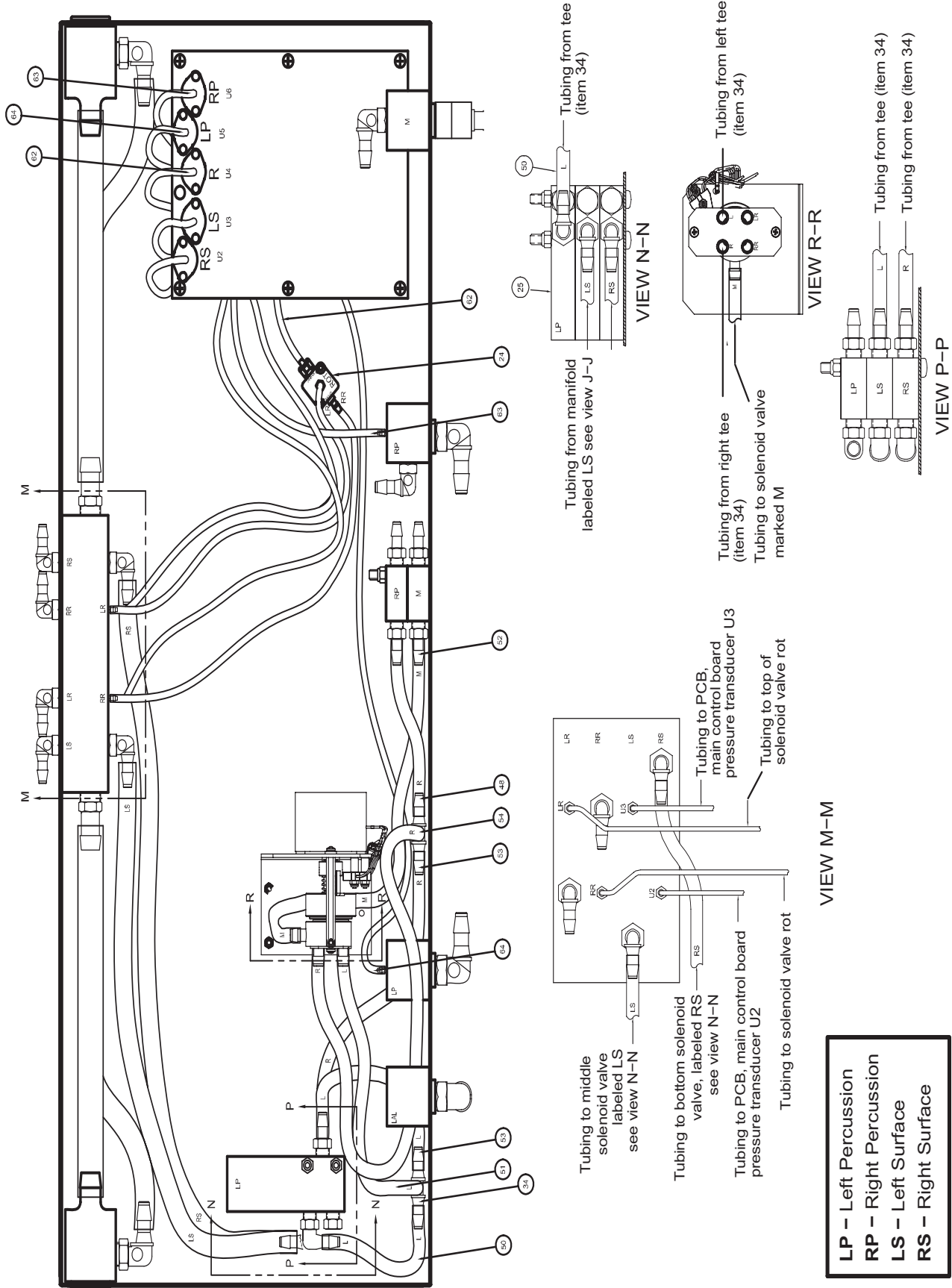

Head Box Assembly - 2950-001-417

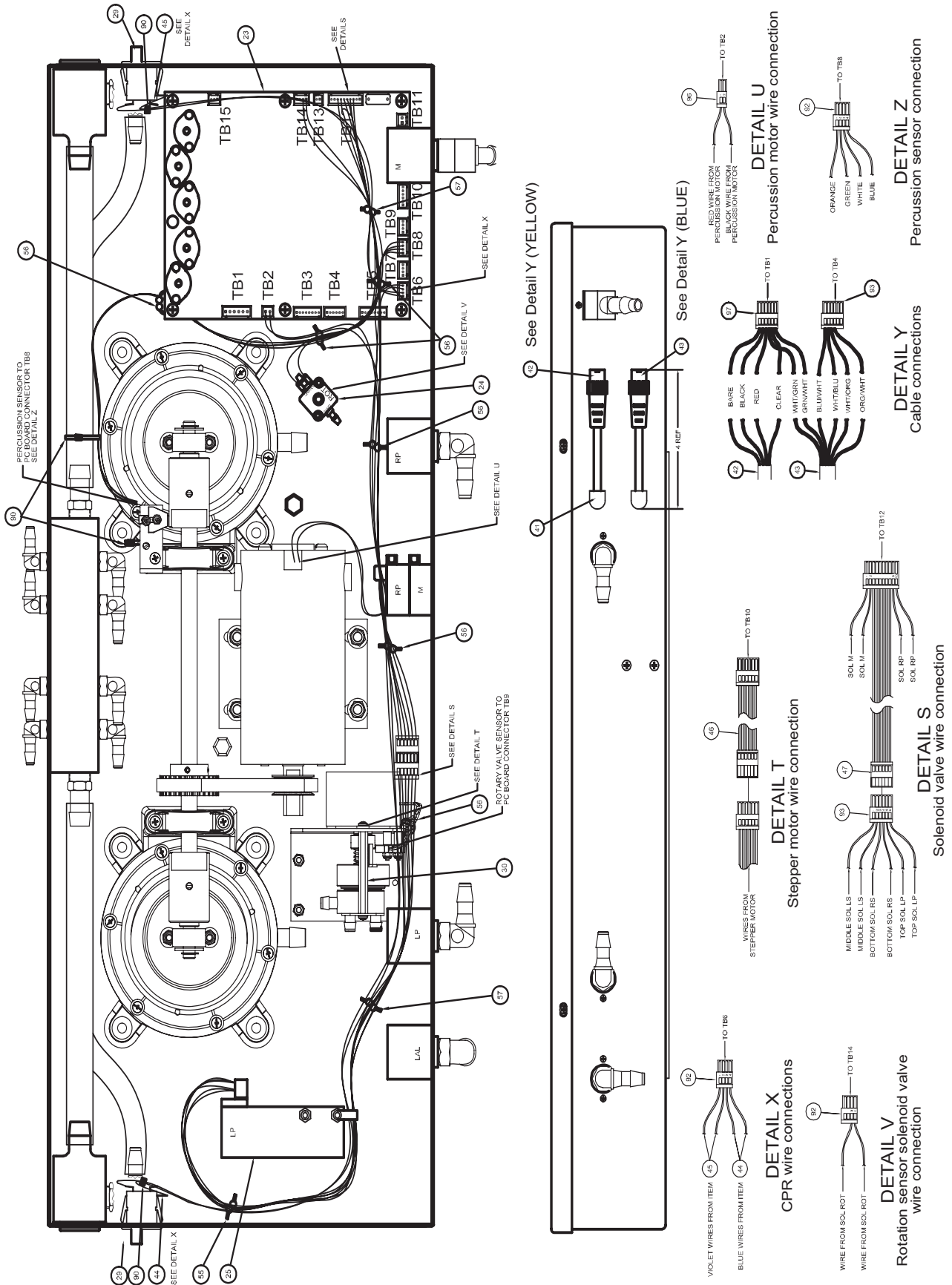

[Return To Table of Contents](#)

Head Box Assembly - 2950-001-417

Item	Part No.	Part Name	Qty.
1	2950-001-201	Box, Head End	1
2	2950-001-202	Cover, Head End	1
3	2950-001-203	Sound Foam	1
4	2950-001-204	Sound Foam	4
5	2950-001-205	Sound Foam	1
6	2950-001-206	Sound Foam	2
7	2950-001-207	Fastener Loop, 1 1/2 Wide x 2 LG	2
8	2950-001-208	Cylinder Assembly, Left	1
9	2950-001-209	Stiffening Plate	1
10	2950-001-210	Locknut, Elastic 1/4-20 UNC	12
11	2950-001-211	Washer, Plain 1/4 SST	12
12	2950-001-212	Shaft Assembly	1
13	2950-001-213	Cylinder Assembly, Right	1
14	2950-001-214	Belt	1
15	2950-001-215	Bearing Block Top	2
16	2950-001-216	Bracket, Sensor	1
17	2950-001-217	Sensor Reflecting Object	1
18	2950-001-218	Screw, PH Mach.	4
19	2950-001-219	Motor, 24VDC	1
20	2950-001-220	Pulley, Motor	1
21	2950-001-221	Manifold Assembly	1
22	2950-001-222	CPR Valve Ring	4
23	2950-001-223	PCB, Main Control Board Assembly	1
24	2950-001-224	Sensor Selector Valve, Solenoid	1
25	2950-001-225	Valve, Solenoid 24VDC	5
26	2950-001-226	Connector, Bulkhead	1
27	2950-001-227	Connector, Bulkhead	1
28	2950-001-228	Connector, Bulkhead	2
29	2950-001-229	Switch, Momentary	2
30	2950-001-230	Carbon Valve Assembly	1
31	2950-001-231	Standoff	2
33	2950-001-233	Socket Snap Brass Nickel Plated	2
34	2950-001-234	Fitting, Tee, Tube, 3/8 NPT	2
35	2950-001-235	Fitting, 90 Deg Elbow, 3/8NPT x 3/8	4
36	2950-001-236	Fitting, 90 Deg Elbow, 1/4NPT x 3/8	5
37	2950-001-237	Fitting, 90 Deg Elbow, 3/8NPT x 1/2	8
38	2950-001-238	Plug, 1/4 NPT	4
39	2950-001-239	Fitting, 1/4NPT x 3/8 ST	8
40	2950-001-240	Fitting Miniature 1/4-28 UNF 1/8 ID Tube Nylon	2
41	2950-001-133	Bushing, Strain Relief, 90 Deg	2
42	2950-002-805	Wire Harness Assembly, Yellow	1
43	2950-001-243	Wire Harness Assembly, Blue	1
44	2950-001-244	Wire Harness Assembly	2
45	2950-001-245	Wire Harness Assembly	2
46	2950-001-246	Wire Harness Assembly	1
47	2950-001-247	Wire Harness Assembly	1
48	2950-001-248	Tubing, Silicone 1/4 ID x 3/8 OD x 4 Lg	1
49	2950-001-249	Tubing, Silicone 1/4 ID x 3/8 OD x 4 1/2 Lg	1

[Return To Table of Contents](#)

Head Box Assembly - 2950-001-417

Item	Part No.	Part Name	Qty.
50	2950-001-250	Tubing, Silicone 1/4 ID x 3/8 OD x 5 Lg	1
51	2950-001-251	Tubing, Silicone 1/4 ID x 3/8 OD x 8 Lg	1
52	2950-001-252	Tubing, Silicone 1/4 ID x 3/8 OD x 8 3/4 Lg	1
53	2950-001-253	Tubing, Silicone 1/4 ID x 3/8 OD x 10 Lg	3
54	2950-001-254	Tubing, Silicone 1/4 ID x 3/8 OD x 19 Lg	1
55	2950-001-255	Lok Twist Nylon .3 Bundle Dia	1
56	2950-001-256	Lok Twist Nylon .5 Bundle Dia	4
57	2950-001-257	Lok Twist Nylon .8 Bundle Dia	2
58	2950-001-408	Post Snap Brass Nickel Plated	2
59	2950-001-259	Tubing, Vinyl 1/2 ID x 3 1/4 Lg	3
61	2950-001-261	Tubing, Vinyl 3/8 ID x 9/16 OD x 11 Lg	2
62	2950-001-262	Tubing, Vinyl 1/8 ID x 15 Lg	1
63	2950-001-263	Tubing, Vinyl 1/8 ID x 17 Lg	1
64	2950-001-264	Tubing, Vinyl 1/8 ID x 30 1/2 Lg	1
65	2950-001-265	Clip, 3/8 ID	1
66	2950-001-266	Clip, 1/2 ID	1
67	2950-001-267	Washer, Nylon .38 ID x .88 OD	2
68	2950-001-268	Ring, Retaining External .338 ID	2
69	2950-001-269	Washer Shim. 166 Id X .375 Ok .125 Thk Alum	1
72	2950-001-272	Screw, Mach Ph Cr 6-32 UNC 2A x 3/8 Lg	7
74	2950-001-274	Screw, Mach Ph Cr 8-32 UNC 2A x 3/8 Lg	6
78	2950-001-278	Screw, Mach Ph Cr 8-32 UNC 2A x 2 Lg	2
79	2950-001-279	SCREW, MACH PH CR 8-32 UNC 2A x 2 3/4 Lg	2
81	2950-001-281	Screw, Plastite Thd Form Ph Cr 6-19 x 1/4 Lg	2
82	2950-001-282	Screw, Plastite Thd Form Ph Cr 6-19 x 3/8 Lg	10
83	2950-001-411	Washer Plain No. 8 SST	2
85	2950-001-285	Lockwasher, Internal No. 8 SST	10
86	2950-001-171	Locknut Elastic, 8-32 UNC	4
87	2950-001-287	Locknut Elastic, 6-32 UNC	3
88	2950-001-167	Locknut Elastic, 4-40 UNC	2
90	2950-001-290	Ty-Wrap, Self Locking Type	A/R
92	2950-001-292	Block Terminal Conn. Female 2.5 Mm 4 Pin	3
93	2950-001-293	Block Terminal Conn. Female 2.5mm 6 Pin	2
96	2950-001-296	Block Terminal Conn. Female 3.5mm 2 Pin	1
97	2950-001-297	Block Terminal Conn. Female 3.5mm 6 Pin	1

ICU Bed Extender Mattress Only - 2950-100-000

2030 & 2040 Models Only

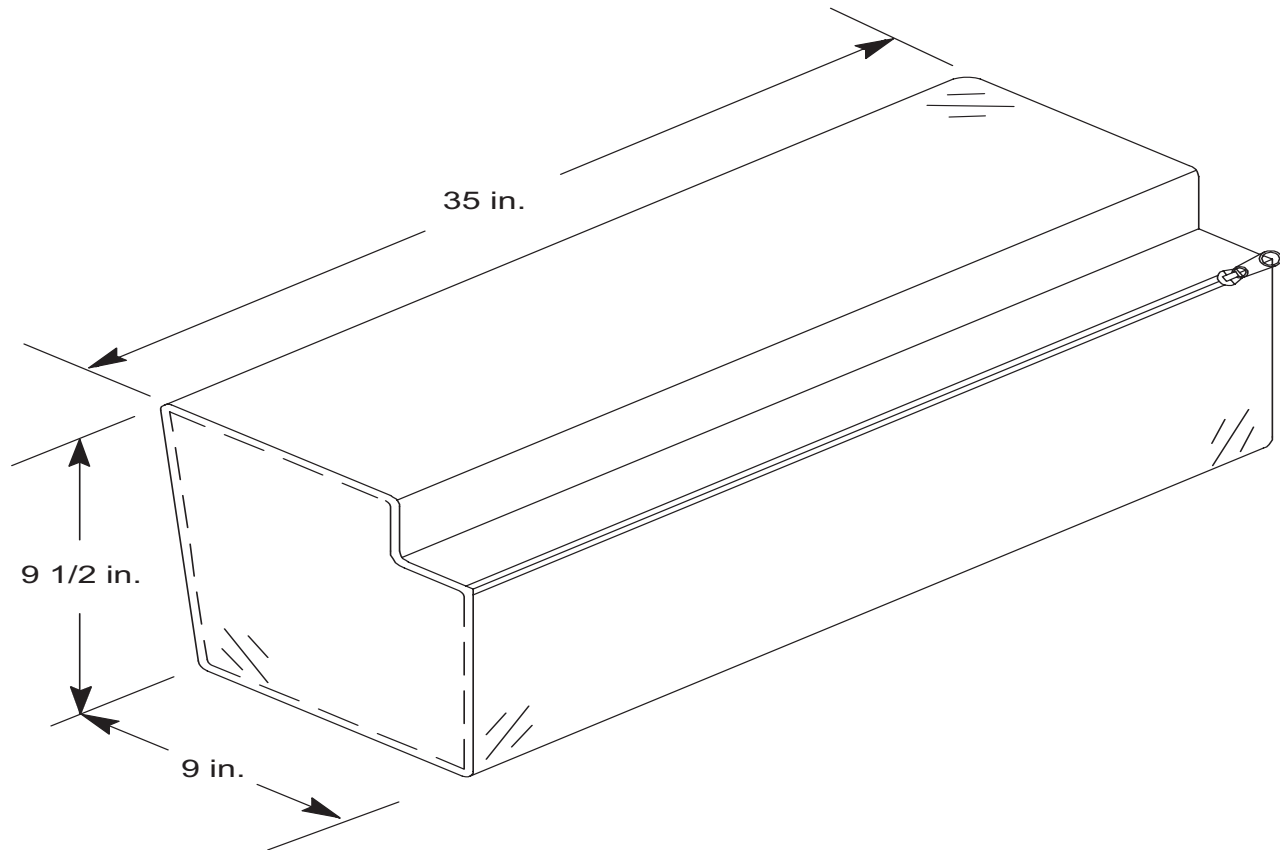

Foot Box Retainer For ICU Only - 2950-700-001

2030 & 2040 Models Only

Reference **2950-700-001** for Foot Box Accessory Kit

[Return To Table of Contents](#)

Warranty

LIMITED WARRANTY

Stryker Medical Division, a division of Stryker Corporation, warrants to the original purchaser the XPRT Powered Mattress Replacement System to be free from defects in material and workmanship for a period of two (2) years after date of delivery. Stryker's obligation under this warranty is expressly limited to supplying replacement parts and labor for, or replacing, at its option, any product which is, in the sole discretion of Stryker, found to be defective. If requested by Stryker, products or parts for which a warranty claim is made shall be returned prepaid to the factory. Any improper use or any alteration or repair by others in such manner as in Stryker's judgment affects the product materially and adversely shall void this warranty. Any repair of Stryker products using parts not provided or authorized by Stryker shall void this warranty. No employee or representative of Stryker is authorized to change this warranty in any way.

Stryker Medical XPRT Powered Mattress Replacement System products are designed for a five (5) year expected service life under normal use, conditions, and with appropriate periodic maintenance as described in the maintenance manual for each device.

This statement constitutes Stryker's entire warranty with respect to the aforesaid equipment. **Stryker makes no other warranty or representation, either expressed or implied, except as set forth herein. There is no warranty of merchantability and there are no warranties of fitness for any particular purpose. In no event shall Stryker be liable here under for incidental or consequential damages arising from or in any manner related to sales or use of any such equipment.**

TO OBTAIN PARTS AND SERVICE

Stryker products are supported by a nationwide network of dedicated Stryker Field Service Representatives. These representatives are factory trained, available locally, and carry a substantial spare parts inventory to minimize repair time. Simply call your local representative, or call Stryker Customer Service USA at 1-800-327-0770, Canada 1-888-233-6888.

SERVICE CONTRACT COVERAGE

Stryker has developed a comprehensive program of service contract options designed to keep your equipment operating at peak performance at the same time it eliminates unexpected costs. We recommend that these programs be activated before the expiration of the new product warranty to eliminate the potential of additional equipment upgrade charges.

A Service Contract helps to:

- Ensure equipment reliability
- Stabilize maintenance budgets
- Diminish downtime
- Establish documentation for JCAHO
- Increase product life
- Enhance trade-in value
- Address risk management and safety

Warranty

SERVICE CONTRACT PROGRAMS

Stryker offers the following service contract programs:

Service Agreement Options *	Gold	Silver	Parts	Labor	PM
Annually scheduled preventative maintenance	X				X
All parts	X	X	X		
All labor and travel	X	X		X	
Unlimited emergency service calls	X	X		X	
Priority one contact: two hour phone response	X	X	X	X	
Most repairs completed within 3 days	X	X		X	
JCAHO documentation	X	X		X	X
On-site record of PM & emergency service	X				X
Factory-trained Stryker service technician	X	X		X	X
Stryker authorized parts used	X	X	X	X	X
Service during regular business hours (8-5)	X	X	X	X	X

* Does not include maintenance due to abuse or for any disposable items. Stryker reserves the right to change options without notice.

Stryker Medical also offers personalized service contracts.
Pricing is determined by age, location, model and condition of product.

**For more information on our service contracts,
please call your local representative.**

RETURN AUTHORIZATION

Merchandise cannot be returned without approval from the Stryker Customer Service Department. An authorization number will be provided which must be printed on the returned merchandise. Stryker reserves the right to charge shipping and restocking fees on returned items. **Special, modified, or discontinued items not subject to return.**

DAMAGED MERCHANDISE

ICC Regulations require that claims for damaged merchandise must be made with the carrier within fifteen (15) days of receipt of merchandise. **Do not accept damaged shipments unless such damage is noted on the delivery receipt at the time of receipt.** Upon prompt notification, Stryker will file a freight claim with the appropriate carrier for damages incurred. Claim will be limited in amount to the actual replacement cost. In the event that this information is not received by Stryker within the fifteen (15) day period following the delivery of the merchandise, or the damage was not noted on the delivery receipt at the time of receipt, the customer will be responsible for payment of the original invoice in full. Claims for any short shipment must be made within thirty (30) days of invoice.

INTERNATIONAL WARRANTY CLAUSE

This warranty reflects U.S. domestic policy. Warranty outside the U.S. may vary by country. Please contact your local Stryker Medical representative for additional information.

[Return To Table of Contents](#)

UNITED STATES
Stryker Medical
3800 E. Centre Ave.,
Portage, Michigan USA
49002

CANADA
Stryker Canada
45 Innovation Drive
Hamilton, Ontario Canada
L9H 7L8

EC	REP
----	-----

European Representative
Stryker France
ZAC Satolas Green Pusignan
Av. De Satolas Green
69881 MEYZIEU Cedex
France

Manufactured for **stryker**[®]
Gaymar P/N 13013 000